

RADIO NEWS

FEBRUARY
1945
35c
In Canada 40c



RN-54-J97724-47
C J PARSONS CRE USN
214 FARRAGUT AVE
ORANGE TEXAS

One advertisement
of a series
appearing in
LIBERTY
Magazine

Buy Your New Radio from Your Radio Dealer



"You will get more satisfaction—better value—from a radio bought through a radio *specialist*—your local radio dealer.

"You will get every worth-while improvement—because my years of experience and technical knowledge enable me to choose the best postwar models.

"Many of us dealers have chosen Meck Radios—because they offer you outstanding engineering advancements as well as a reputation for quality firmly established through years of building world-famed electronic products."



ONE OF THE NEW
MECK RADIOS

Your Radio Dealer.



MECK RADIOS

JOHN MECK INDUSTRIES • PLYMOUTH, INDIANA, U. S. A.

TABLE MODELS • PORTABLES • CONSOLES • PHONOGRAPHS



Radio Servicing pays many good money for full time work. Many others make \$5, \$10 a week EXTRA fixing Radios in spare time.

Building This

A. M. SIGNAL GENERATOR gives you valuable experience. Provides amplitude-modulated signals for test and experiment purposes.

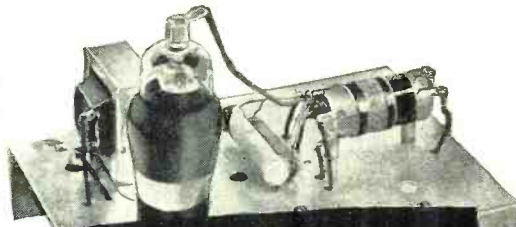

Learn RADIO by PRACTICING in Spare Time

with 6 Big Kits of Radio Parts I Send You

Here's a *practical* way to learn Radio at home in spare time—to train for a good Radio job, or start your own spare time or full time Radio Service Business! You get Radio EXPERIENCE building real Radio Circuits with kits of standard parts I send. You get solid KNOWLEDGE of Radio, Television, Electronic fundamentals from my easy-to-grasp lessons. You follow the same "50-50" method that has helped hundreds of beginners make \$5, \$10 EXTRA a week in spare time while learning—and prepare for good full time jobs at good pay.

Future Looks Bright for Trained Radio Technicians, Operators

The Radio Repair Business is booming. Profits are large and peacetime prospects are bright. Broadcasting Stations, Aviation Radio, Police Radio, Loudspeaker Systems, Radio Manufacturing, all employ trained Radio men at good pay.

Be Ready to Cash in on Jobs Coming With Television, Electronics

Think of the NEW jobs that Television, Frequency Modulation, Electronics, other Radio developments promise for the peacetime future. You have a real opportunity. I will train you to be ready to cash in when amazing wartime Radio developments are released for unlimited peacetime use.

Mail Coupon for Free Copy of Lesson and 64-page Illustrated Book

I will send you FREE, a sample Lesson, "Getting Acquainted with Receiver Servicing," to show you how practical it is to train for Radio in spare time. And with it I'll send FREE, my 64-page, illustrated book, "Win Rich Rewards in Radio." It describes many fascinating jobs in Radio, tells how you can get started. No obligation—no salesman will call. Just mail coupon in an envelope or paste it on a penny postal.—**J. E. SMITH, President, Dept. 5BR, National Radio Institute, Pioneer Home Study Radio School, Washington 9, D. C.**

My Course includes Training in TELEVISION • ELECTRONICS • FREQUENCY MODULATION



You build this SUPERHETERODYNE

CIRCUIT that brings in local and distant stations. You get *practical* experience putting this set through fascinating tests.

You build this MEASURING INSTRUMENT

yourself early in the course—use it for practical Radio work on neighborhood Radios to pick up EXTRA spare time money!

BE A SUCCESS in RADIO I Will Train You at Home

Sample Lesson FREE

GETTING ACQUAINTED WITH RECEIVER SERVICING

Gives hints on Receiver Servicing. Locating Defects. Repair of Loudspeaker, I.F. Transformer, Gang Tuner Condenser, etc., 31 illustrations. Study it—keep it—use it—without obligation! Mail Coupon NOW for your copy!



GET BOTH 64 PAGE BOOK SAMPLE LESSON FREE

MR. J. E. SMITH, President, Dept. 5BR. NATIONAL RADIO INSTITUTE, Washington 9, D. C.

Mail me FREE, without obligation, Sample Lesson and 64-page book, "Win Rich Rewards in Radio." (No Salesman will call. Please write plainly.)

Name.....Age.....

Address.....

City.....Zone.....State.....4FR





Reg. U. S. Pat. Off.

CONTENTS

FEATURES

Electronic Flight Recorder... Thomas B. Thomson and Willard C. North 25
Transmission Lines at 200 Mc. ... Thos. A. Garretson 28
Electrical Computing Airborne Gunsight... Russell H. Lasche 32
Wacs at Work... Edgar F. G. Swasey 35
'Electronically Yours,—G.I. Joe'... William E. Taylor 36
Power Supply Filter Design... Harold S. Renne 38
Bomber's Ears ... 41
Tone Control Circuits for Phonographs... F. E. Winter 42
Radio for Transit Utilities... Joan David 44
The Television Channel... Edward M. Noll 46
Multi-Band 30 Watt Transmitter... McMurdo Silver 48
Let's Talk Shop... Joe Marty 51
Practical Radio Course... Alfred A. Ghirardi 52
The Cathode Follower... G. Donald Hendricks 54
Theory and Application of U.H.F. ... Milton S. Kiver 58
French Underground Network During German Occupation... Kenneth R. Porter 72

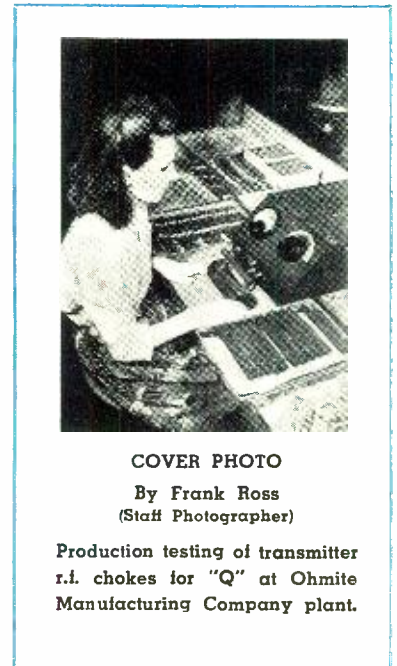

COVER PHOTO
By Frank Ross
(Staff Photographer)
Production testing of transmitter r.f. chokes for 'Q' at Ohmite Manufacturing Company plant.

DEPARTMENTS

For the Record... 8
Spot Radio News... 12
International Short-Wave... Kenneth R. Boord 56
QTC ... Carl Coleman 60
Technical Book and Bulletin Review... 62
What's New in Radio... 66
Within the Industry... 118

Copyright, 1945
ZIFF-DAVIS PUBLISHING COMPANY
Editorial Offices: 540 N. Michigan Ave., Chicago 11, Ill.
Member of the Audit Bureau of Circulation

RADIO NEWS is published monthly by the Ziff-Davis Publishing Company at 540 N. Michigan Ave., Chicago 11, Ill. New York Office, Empire State Building, New York 1, N. Y. Washington, D. C., Office, International Building, 1319 F Street, N.W. Washington 4, D. C. Los Angeles Office, William L. Pinney, Manager, 815 S. Hill St., Los Angeles 14, Calif. Subscription Rates: In U. S. \$3.00 (12 issues), single copies, 35 cents; in Mexico, South and Central America, and U. S. Possessions, \$3.00 (12 issues); in Canada \$3.50 (12 issues), single copies 40 cents; in British Empire, \$4.00 (12 issues); all other foreign countries \$6.00 (12 issues). Contributors should allow at least 2 weeks for change of address. All communications about subscriptions should be addressed to: Director of Circulation, 540 N. Michigan Ave., Chicago 11, Ill. Entered as second class matter March 9, 1938, at the Post Office, Chicago, Illinois, under the Act of March 3, 1879. Entered as second class matter at the Post Office Department, Ottawa, Canada. Contributors should retain a copy of contributions. All submitted material must contain return postage. Contributions will be handled with reasonable care, but this magazine assumes no responsibility for their safety. Accepted material is subject to whatever adaptations, and revisions, including by-line changes necessary to meet requirements. Payment covers all authors', contributors' or contestants' rights, title, and interest in and to the material accepted and will be made at our current rates upon acceptance. All photos and drawings will be considered as part of material purchased.

WILLIAM B. ZIFF
Publisher
B. G. DAVIS Editor C. R. TIGHE Ass't to Publisher
OLIVER READ, W9ETI
Managing Editor
WM. A. STOCKLIN Associate Editor HAROLD S. RENNE Technical Editor
JOE MARTY, JR. Field Editor FRED HAMLIN Washington Editor
HERMAN R. BOLLIN Art Director E. H. SEHNERT Chief Draftsman
K. R. PORTER War Correspondent FRANK ROSS Staff Photographer
GEORGE BERNER Advertising Director
S. L. CAHN Advertising Mgr. J. M. ECKERT Midwest Adv. Mgr.
H. G. STRONG Circulation Director H. J. MORGANROTH Production Director



**"HOGARTH HAS ALREADY OCCUPIED
THIS ISLAND—ALL SHE CAN SAY IN
ENGLISH IS ECHOPHONE EC-1"**



ECHOPHONE MODEL EC-1

(Illustrated) a compact communications receiver with every necessary feature for good reception. Covers from 550 kc. to 30 mc. on 3 bands. Electrical bandspread on all bands. Six tubes. Self-contained speaker. 115-125 volts AC or DC.



ECHOPHONE RADIO CO., 540 NORTH MICHIGAN AVE., CHICAGO 11, ILLINOIS

1945

1945 dawns clear and bright . . . with new hope on the horizon . . . a hard-to-restrain spirit of optimism rewarding a nation unified in pursuit of Victory. Until Peace has been won, we at FADA are devoting all our resources and energies to the war effort. Our post-war promise will be revealed in performance.

PLACE YOUR FAITH
IN THE

FADA

Radio

OF THE FUTURE

Famous Since Broadcasting Began!

FADA RADIO AND ELECTRIC COMPANY, INC., LONG ISLAND CITY, N. Y.

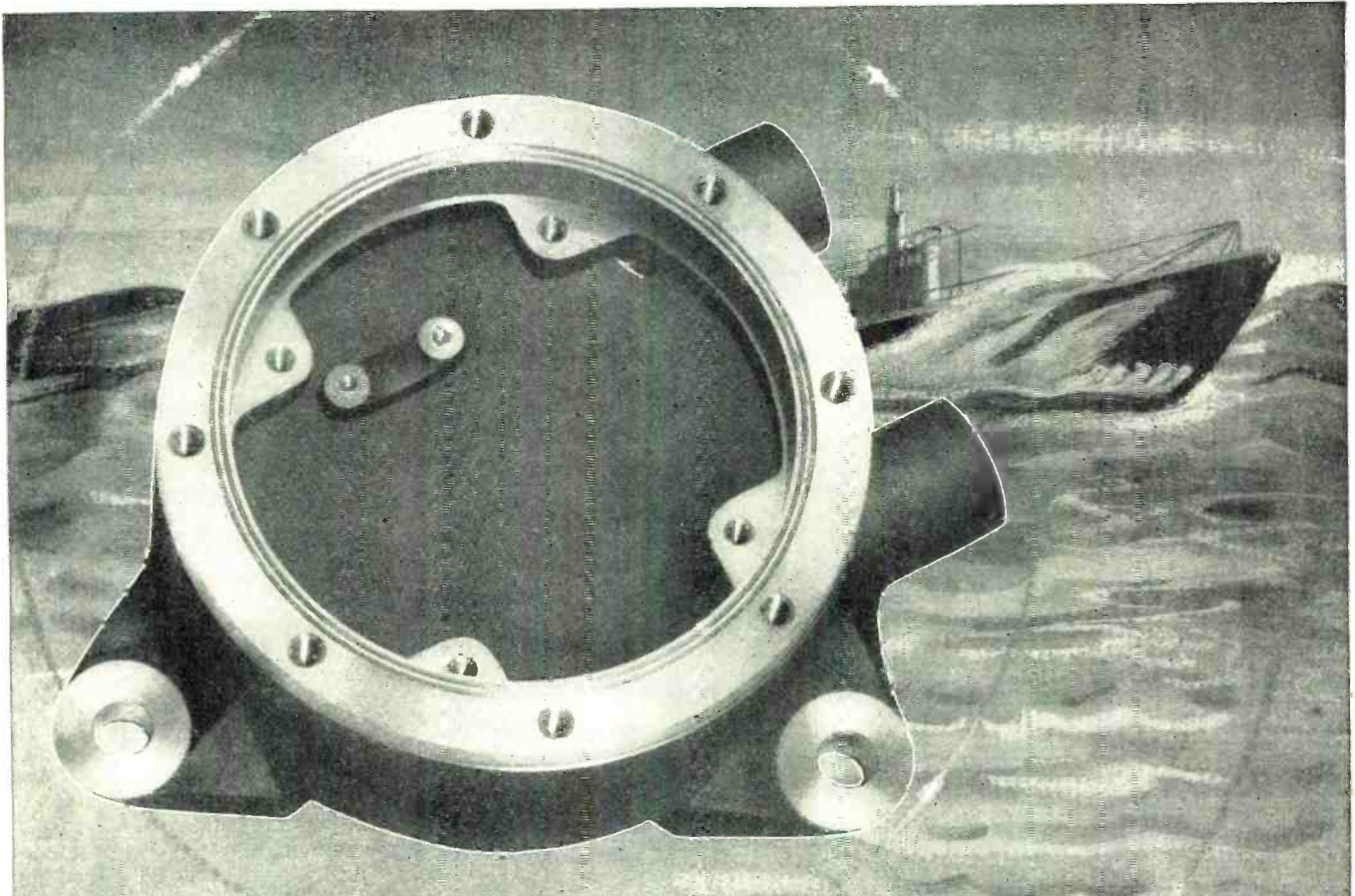

A POSTWAR LOUD SPEAKER?

YES, if you are going to use it on a submarine. But don't expect all Jensen postwar loud speakers to look like this. This one was designed especially to be used on submarines and to withstand the terrific pressure of fathoms of deep sea water and the explosive concussion of depth charges.

Just the same, Jensen Engineers and factory have learned plenty in the process of designing this and many other

specialized speakers for front line operations. Jensen postwar speakers will reflect this experience in the most extensive and improved line of loud speakers ever known. More than ever before, every buyer and user of a loud speaker will find positive assurance of the most advanced art in Jensen products. Intensive specialization for more than 15 years is one good reason for that... Jensen alone can claim that distinction.



Jensen

RADIO MANUFACTURING COMPANY
6601 S. Laramie Ave., Chicago 38, U.S.A.

Manufacturers and Designers of Fine Acoustic Equipment

AUDAX

RELAYED-FLUX
Microdyne

Long before this war began
AUDAX PICKUPS were in

SELECTIVE SERVICE

Since pickups first became important commercially, the distinguished products of AUDAX have been SELECTED wherever and whenever the requirements were exacting.

Today AUDAX magnetically powered pickups are SELECTED for War contracts that demand the highest standards of performance, regardless of climatic variations or severe handling.

Our stern peacetime standards, maintained for so many years, have proven comfortably adequate to meet government specifications.

The sharp, clean-cut facsimile reproduction of MICRODYNE is a marvel to all who have put it to the only test that really matters . . . the EAR TEST.

AUDAX COMPANY

500-N Fifth Ave., New York 18, N. Y.

Creators of High Grade Electrical
and Acoustical Apparatus Since 1915

Send for your copy of our informative
"PICK-UP FACTS"

★ BUY
WAR BONDS

"The Standard by Which Others
Are Judged and Valued"



FOR THE RECORD

by the editor

THE acceptance of television by Mr. and Mrs. America will depend a great deal upon the proper use of the lowly antenna. The television user can't toss a wire out of his window—hook to a convenient radiator—or coil a homemade loop under the living room rug and still get satisfactory results. The very heart of a satisfactory television installation is the special antenna required for optimum performance. It is just as vital as any other component and can't be connected by haywire techniques. Good television pictures require that adequate signal strength be supplied to the input terminals of the set. Without a satisfactory signal good pictures will be conspicuous by their absence.

In cities like Chicago, New York, Pittsburgh, etc., where thousands of families live in apartment buildings, the problem of installing adequate television antennas will reach major proportions. The use of high frequencies for television channels means, by their very characteristics, that receiving antennas must, of necessity, be designed to take full advantage of their directional receiving properties. There is, at the present stage of the art, only one antenna system suitable to serve a large number of television sets tuned to different stations. It uses a new type amplifier and is quite costly. There is another problem which must be considered as new television stations come on the air. With widely scattered transmitter locations signals will emanate from various directions and it will be necessary to consider this when installing television antenna systems.

Amateur radio ops realized long ago that if they were to obtain optimum results from their high-frequency equipment that special antennas would have to be designed that would give them the added advantage of a directional system. For example, it was found that best results were obtained when the antenna was located high above the building and well away from trees, metal stacks, towers, etc. It was soon discovered that the most successful antennas were those which could be rotated and, like a "radio searchlight," be directed to the source of the signal. Equally important was the

design of special transmission lines between the antenna elements and the receiver. This, too, must be considered in the design of any television antenna system. It is our guess that the American radio amateur will again solve this problem. He's solved many others which have been directly responsible for the very existence of radio broadcasting (now in its 25th year).

Many of our readers are familiar with the many forms of high-frequency antennas that use directors and reflectors to obtain the desired results. Such antennas are ideally suited for the reception of television signals. However, their general use by the public would meet with many obstacles. Lacking a technical "know how," Mrs. Jones would not be proficient with its use. If she lived in a city having, say, five television stations in five different directions, it is doubtful that she would take the necessary precautions to rotate the receiving antenna to its proper position for each station.

Engineers and amateurs have a golden opportunity at hand for the development of successful and flexible television antenna systems. It is a problem that should be studied now. It should not wait for the end of the war. At this writing, the FCC has not rendered its decision on television frequencies. But, no matter what this decision may be, the fact still remains that television cannot be successful on any frequency until the antenna problem has been solved.

RADIO NEWS joins in extending hearty congratulations to the Radio Broadcasters—who are celebrating their 25th anniversary. Now in our 26th year of publication—we have seen the art of broadcasting develop from a meager beginning to one of the most cherished of man's possessions. From its swaddling clothes has emerged a tremendous public service. To the radio amateur must go much of the credit for its growth. Out of the attic and basement has come developments—directly responsible for its technical achievements. Yes—the ham is indispensable to American radio progress. O. R.

No Tools Required to Install These ATTACHABLE SWITCHES for Mallory Volume Controls

THEY'RE easier to install than any other "off-on" snap switch—no tools are required to attach them to volume controls! That's why so many service men prefer to use Mallory Attachable Switches.

The Mallory switch designed for controls of 1½" diameter fits Mallory standard universal controls, carbon and wire-wound types, TRP tapped controls and Universal

dual controls. The Mallory switch designed for 1⅝" diameters fits Mallory MR, MK, UM, TM and DTM controls.

Both may be rigidly mounted without any bending or alteration of the volume controls. Both are available in circuit arrangements to suit any type of application. See your Mallory distributor!

P. R. MALLORY & CO., Inc., INDIANAPOLIS 6, INDIANA



For
1½" Diameter
Controls

To attach switch, remove dust-proof plate from back of control.

ACTUATING ARM

Turn shaft as far as it will go in clockwise direction.

Make sure switch actuating arm is in proper position, as pictured.

PRESS AND RAISE AT THIS SIDE TO REMOVE SWITCH

Insert tongue of switch into long slot. Press down, slide up slightly and switch will snap into place. Move back slightly to lock.

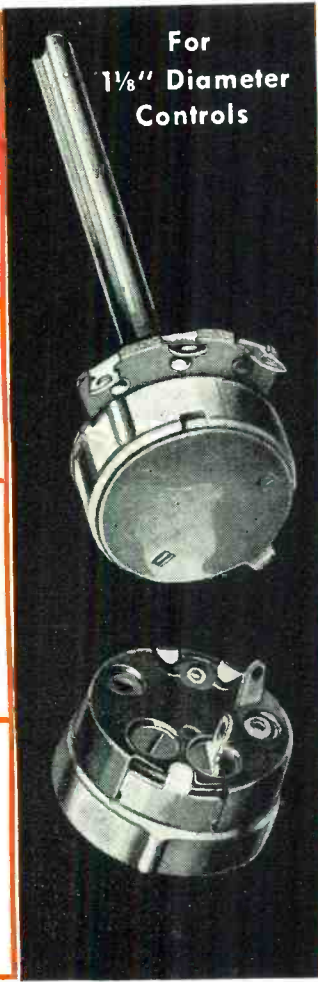

For
1⅝" Diameter
Controls

Remove cover.
Line up switch actuator of volume control with Letter V.

TAB
DIE STAMPED LETTER V
SWITCH CAM

Line up switch cam with Letter V.

GUIDE RIB (CONTROL CUP)
GUIDE RIB (SWITCH CUP)
LANCED EARS (CONTROL CUP)
TABS (SWITCH CUP)

Line up guide rib on switch and on control as shown, press switch down tightly until switch tabs snap over ears on control cup. To remove switch, bend up ears.

More than ever—
ALWAYS
INSIST ON

P. R. MALLORY & CO. Inc.
MALLORY
APPROVED
PRECISION PRODUCTS

VIBRATORS • VIBRAPACKS* • CONDENSERS
VOLUME CONTROLS • SWITCHES • RESISTORS
FILTERS • RECTIFIERS • POWER SUPPLIES

ALSO MALLORY "TROPICAL" DRY BATTERIES, ORIGINALLY DEVELOPED BY MALLORY FOR THE U. S. ARMY SIGNAL CORPS, NOT PRESENTLY AVAILABLE FOR CIVILIAN USE.

©Trademark

CONTROLS FOR POSTWAR PRODUCTS

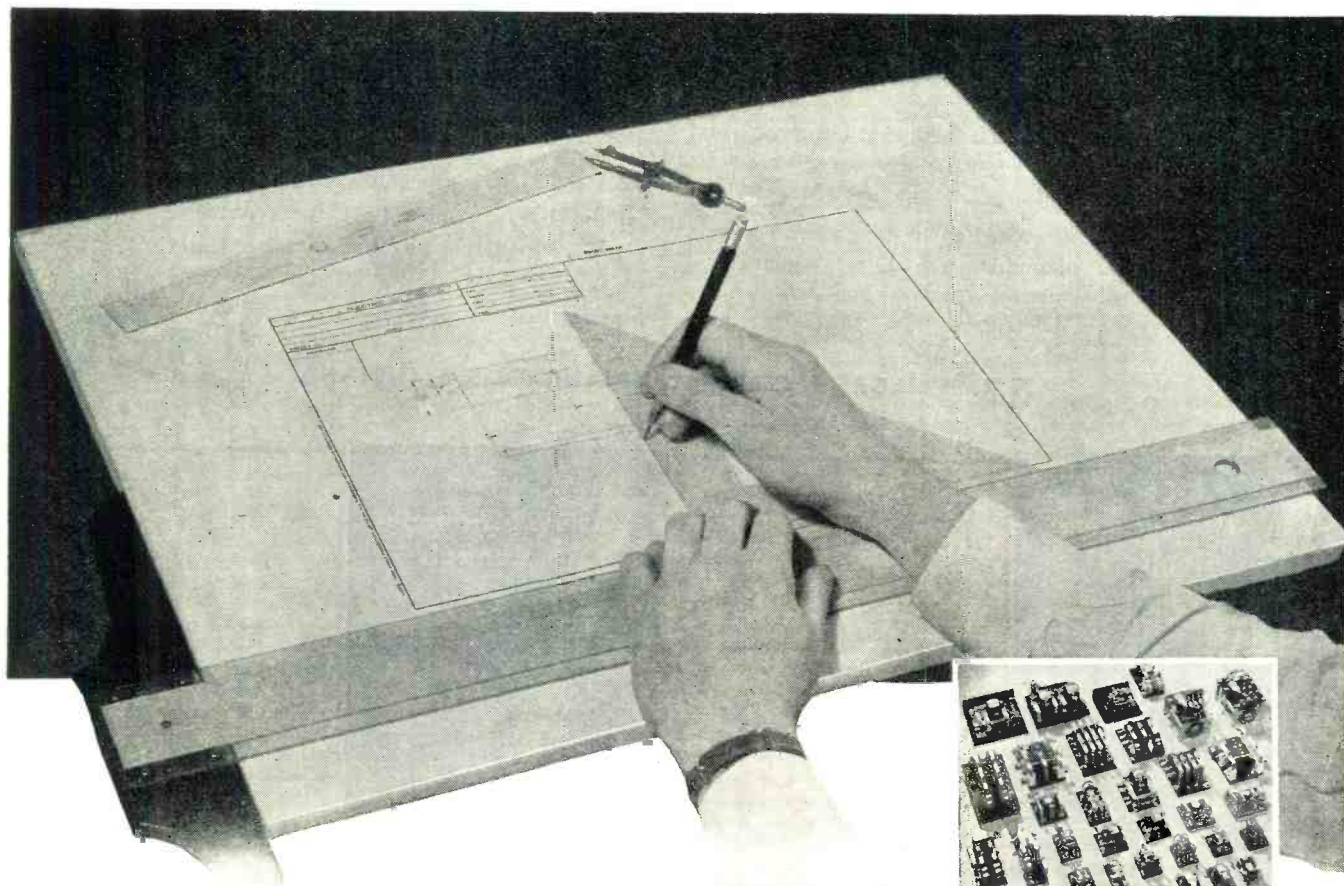

With the rush to catch the earliest possible markets with post-war products, it is important that they be designed with units that can be procured without undue delay. Manufacturers of equipment requiring electric controls will find Ward Leonard Relays, Resistors and Rheostats readily available without "time-out" for redesigning. Facilities at Ward Leonard used to produce products for war purposes required little or no conversion. To serve post-war markets, they will likewise require a minimum of reconversion. Make your selection from the Ward Leonard Line. Let us send you bulletins describing controls of interest to you.



RELAYS for light, intermediate and heavy duty, sensitive, transfer, time delay, antenna changeover, break-in and latch-in operation.

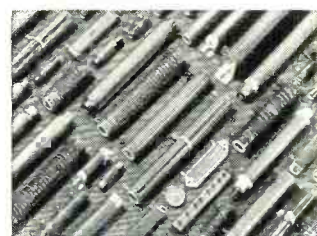

RESISTORS that withstand heat, moisture, vibration and other adverse conditions. Wide range of types, ratings, terminals and enclosures.



RHEOSTATS that include the widest range of sizes, types and current ratings from the tiny ring types for radio to huge industrial assemblies.

WARD LEONARD

RELAYS • RESISTORS • RHEOSTATS



Electric control  devices since 1892.

WARD LEONARD ELECTRIC COMPANY • 47 SOUTH ST. • MOUNT VERNON, N. Y.

SYLVANIA NEWS

RADIO SERVICE EDITION

FEBRUARY

Published in the Interest of Better Sight and Sound

1945

**SYLVANIA
SERVICEMAN
SERVICE**



by
FRANK FAX

Neat, attractively styled service garments make a good impression on customers and save wear and tear on ordinary clothes.

For wear in the shop, working on auto radios, or even in customers' homes, Sylvania offers well tailored, practical service coats and jackets. Made of serviceable double-strength herringbone weave dungaree cloth in a green and white mixture, giving a tweed effect, both garments are provided with roomy pockets. Jacket is of single breasted three button style with full sleeves, while coat has a special button arrangement which allows for tails to be buttoned in front, offering added trouser protection when kneeling.



Available in five popular sizes—36, 38, 40, 42 and 44, coats are priced at \$1.95 each, jackets in same sizes at \$1.75.

Order from your local Sylvania distributor, or send your order to Frank Fax, Sylvania, Emporium, Pa.

Servicemen Find Plenty of Ideas in Sylvania's Model Shop Layout

Booklet Packed With Helpful Hints On Low-Cost Steps in Modernization

Servicemen can do more than dream about that model service shop. For Sylvania comes through with plenty of practical, down-to-earth suggestions in "The Sylvania Model Service Shop," the book prepared to help radio servicemen modernize their shops at a cost compatible with earnings.

REWIRING SETS AIDS BUSINESS

Servicemen who have been revamping sets to meet wartime shortages of tubes have not only been doing a fine job for their customers, but they have also been building up future business for themselves.

When tubes and other replacement parts are freely available, servicemen will have an opportunity to restore sets to their original circuits. Customers whose sets were kept operating by emergency re-wiring will naturally come back to the serviceman who helped them.

Future repair jobs will be simplified by the wide use which servicemen made of the Sylvania Warning Cards. These cards show the changes made in the set, and thus save the serviceman valuable time in restoring the receiver to its original condition.

The book describes an actual shop designed and built by Sylvania with three things in mind: economy, efficiency and attractive layout. Every section of the model shop is described in full detail, from entrance, through office and testing department to repair section. Clearly written descriptions are supplemented by readily

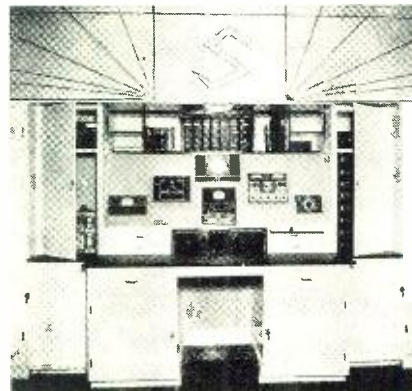

Here is the actual Model Shop built by Sylvania to help servicemen with their modernization plans.

understandable floor plans, and all recommendations are practical ones. A handy list of important instruments, tools and equipment that every shop should have is also included.

Whether he wants to "start from scratch" or merely make a few minor changes, every serviceman will find the "Sylvania Model Service Shop" a valuable guide in improving the appearance and efficiency of his shop. Nor will he have to wait until after the war, because many of the ideas can be put into effect right now by resourceful servicemen.

Price of the book is ten cents, and it may be obtained from Sylvania Electric Products Inc. Emporium, Pennsylvania.

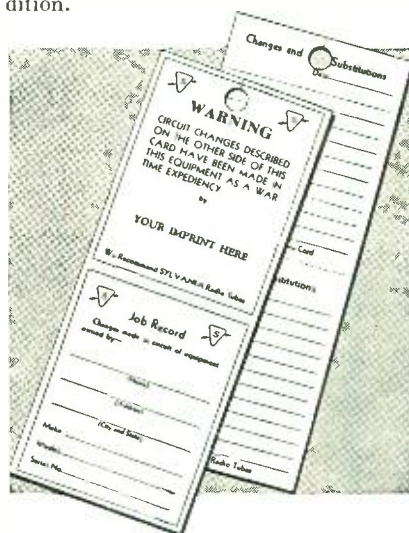

SYLVANIA  **ELECTRIC**

PRODUCTS INC.
Radio Division • Emporium, Pa.

MAKERS OF FLUORESCENT LAMPS, FIXTURES, ACCESSORIES, INCANDESCENT LAMPS, RADIO TUBES, CATHODE RAY TUBES, ELECTRONIC DEVICES

February, 1945

11

Designed for



Application



No. 33991
Voltage Regulator
Tube Socket

Sturdy, compact with dependable contacts. Another in the series of Millen "Designed for Application" components for modern circuits. For use with miniature neon type dual contact bayonet base voltage regulator tubes such as Radiotron No. 991.

**JAMES MILLEN
MFG. CO., INC.**

MAIN OFFICE AND FACTORY
**MALDEN
MASSACHUSETTS**



Spot Radio News

By RADIO NEWS Washington Correspondent



Presenting latest information on the Radio Industry.

THE FCC FRONT saw another delay, that of the confirmation of Paul A. Porter as Commissioner to succeed James Lawrence Fly. Although Mr. Porter's name had been submitted weeks ago, the heavy calendar of the Senate Committee charged with approving such nominations, precluded such action. The *sine die* adjournment of Congress then ended all hopes of confirmation during the 78th Congress session. The President therefore has been required to resubmit the nomination to the next session of Congress which convened January 3. The Senate Committee of this session began new studies of the nomination. It is expected that confirmation will come soon after the Committee meets and by the time this column appears, Mr. Porter should be FCC Commissioner and probably chairman of the FCC, too.

The Commission probably will have still another new Commissioner in its ranks shortly after the beginning of the new year, a Commissioner who will fill the post left vacant by Commander T. A. Craven. It appears as if the FCC assistant general counsel in charge of broadcasting, Rosel H. Hyde may be that new Commissioner. Mr. Hyde was in the running last year, when E. K. Jett was nominated and named FCC Commissioner.

Accelerated action on the allocation program also is expected when the FCC panel is completed with its new Commissioners.

POSSIBILITIES OF RESUMING civilian receiver production before the defeat of Japan do not seem to be too bright, according to L. J. Chatten, the new director of the radio and radar division of the WPB. Appearing before a meeting in New York and industry committee groups, he said that tubes and other parts still are tight and will continue to be that way for a long time. During the next five months, three times as many tubes will be required by the military for replacement in depots. Over 85% of the current production will be required by the military even after Germany is defeated. This leaves 15% for civilian production, and with the shortages of tubes and components, manufacturers are going to find many production hazards, according to Mr. Chatten.

Discussing the spot authorization plan, which permitted the manufacture of a variety of civilian items, Mr. Chatten said that radios and automobiles were about the only two products that were omitted from the plan. And they will not be placed in that produc-

tion category, unless a miracle occurs, he said. The only nonmilitary radio authorizations that have been extended thus far have been for small quantities of two-way apparatus for police, forestry, and emergency work.

To accelerate production, a *Victory First* program has been instituted by the industry. A maximum peak production of \$250,000,000 a month by March 1, has been set as a goal.

The tube front presents the most serious problem, for military requirements are still growing. Approximately 10,000,000 receiving-type tubes are now required every month by the military. The end of the European war will reduce this requirement slightly, and not until at least one year after Germany's defeat is a reduction expected. At present, this appears to be about 45%. In view of these military requirements, but 13% of the total receiver production is available for civilian replacement purposes. WPB estimated that about 19,000,000 tubes were made for replacement purposes, while the demands exceeded 36,000,000. In the first quarter of 1945, about 2,000,000 tubes a month are scheduled. This is about 500,000 more than previously allocated. Within four months after V-E day, a civilian production of 4,000,000 tubes a month is anticipated. Although this production schedule is a substantial one, it still will not meet all demands. For, according to WPB, the combined military and civilian requirements after Germany's defeat, still will be 60% to 70% above present production rates!

RADIO'S ROLE IN THE famous Red Ball Express transport system on the Western front was applauded loudly recently by military executives of the Motor Transport Brigade. Thanks to the communications system initiated by the Signal Corps, a continuous flow of traffic was possible. In addition, it was possible to maintain constant contact with each convoy, follow its travel, and know the exact destination. Thus, upon arrival of the convoy, radio could direct the vehicles to other destinations, without loss of time.

A six-station radio network provided the communications link. The control station was located at brigade headquarters. And one of the stations was located at a terminal of the highway. Here the convoys were formed and sent out to their respective destinations. When a convoy started out from the regulating point, a message was forwarded to all the stations along the route, describing the contents and destination, and providing

RADIO NEWS

CHECK on this "QUICK-CHECK" Feature of the Solar Capacitor Analyzer . . .



THE SOLAR MODEL CE Capacitor Examiner speedily locates common defects in capacitors without disconnecting condensers—often eliminating further tests. This saving of time and labor is accomplished by the unique Solar "QUICK-CHECK" feature.

In this *single* instrument are combined the simplest, most convenient methods for examining the true condition of every capacitor in ordinary use . . . shorts, opens, intermittents, high R.F. impedance and high power factor.

Catalog IN-1 illustrates and describes features of all models. Send for your copy today.



Solar Mfg. Co.

ANOTHER HELPFUL SOLAR SERVICE

**SOLAR CAPACITOR SALES CORP.
285 Madison Avenue, New York 17, N. Y.**

Please send me a copy of Catalog IN-1 on Solar CAPACITOR ANALYZERS.

Name _____

Title _____

Company Name _____

Street Address _____

City _____ State _____

SEND THIS COUPON IN—TODAY

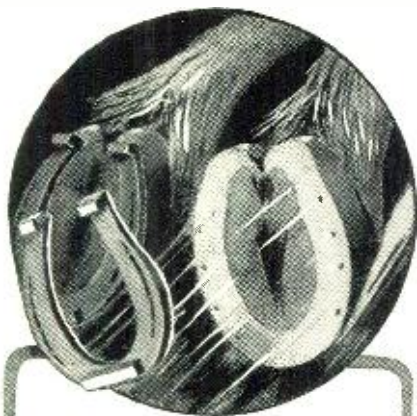

"For the want of a shoe" . . .

For the want of a WRENCH a nut was loose

A handy WALDEN WORCESTER WRENCH would have tightened that nut . . .

Special Aircraft WRENCHES to your order.

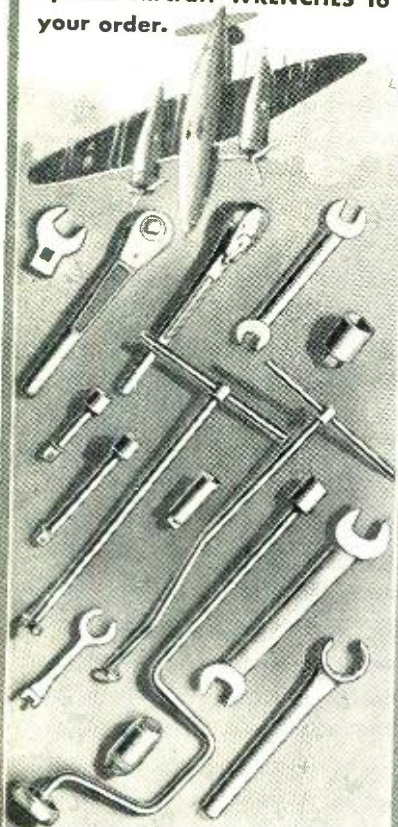

Send for Catalog No. 141 picturing a full line of Automobile, Aircraft and Radio Tools.

WALDEN WORCESTER WRENCHES

STEVENS WALDEN, INC.

468 SHREWSBURY STREET

WORCESTER, MASSACHUSETTS

full instructions as to how it was to be handled. The net control station handled as many as 93 messages a day, each message approximating 60 words. These messages were cataloged into groups, with five letters to a group. In one day, over 5000 groups were transmitted.

The network also was linked to a telephone circuit feeding into general headquarters, permitting the use of the entire communications network at any time.

RADIO BROADCASTING'S TWENTY-FIFTH year will be celebrated in 1945 by the entire manufacturing and broadcasting industry. The silver anniversary will be exploited in magazines, newspapers and radio programs. Broadcasts will even feature a special 25th-year musical score. And *Pledged to Victory* will be the keynote of the broadcasts throughout the year.

DISC RECORDING WAS QUITE POPULAR with the USO in 1944. The 3000 units in this country and off-shore bases used 170,000 discs for *live letters*. The servicemen visiting the USO club houses found record playing to their liking too. They used 60,000 playing needles, 8,000 cutting needles and 20,000 new records.

The postwar era probably will see a boom in disc-record buying, according to several disc manufacturers, recently interviewed. The present average of around 130,000 records a year is expected to increase to 250,000 or more. This increase is based upon the general trend toward the manufacture of more combination phonoreceivers. The 6,000,000 record players individually and in receivers, now in use, will probably be more than tripled, according to the recording specialists.

AN INCREASE OF OVER 3,000,000 radio families in 1944 was revealed by the research department of the Columbia Broadcasting System, who recently completed a survey of radio ownership in this country. There are now, according to this study, over 32,000,000 radio families. In 1940, there were only about 28,000,000 radio families. Substantial gains appear in the East North Central, South Atlantic, Mountain, and Pacific areas. In the South Atlantic area, for instance, an increase of nearly a million was noted. The Mountain zone family ownership increased from 901,546 to 1,011,700. A radio ownership percentage of 88.9 throughout the entire country was also revealed. In the New England, Middle Atlantic, Pacific, and East North Central States, averages above 95% were noted.

AROUND 100 MANUFACTURERS ARE expected to make home receivers in the postwar era. Of this group, 40 are newcomers. None but licensed manufacturers (licensed under RCA, Hazeltine, Latour, or Armstrong patents), are included in this estimate.

For there will probably be countless others who will make receivers in one form or another.

Several distributors, instrument companies, and motion picture equipment manufacturers will be found among the new receiver manufacturers. Receivers will be sold through distributors to dealers, dealers direct, and from the factory in some instances.

THAT VITAL DECISION on frequency allocations, probed during the recent five-week FCC hearings, was not made on December 1 of last year, as originally planned. The avalanche of testimony and bids for frequencies buried the experts studying the details and months, instead of weeks, were required to solve all the problems akin to the organization of the spectrum. At the present writing it appears as if a decision might be made during the early part of February.

The State Department, who originally set the decision deadline of December 1, sent their experts over to confer with the FCC to align differences. These experts are members of the Interdepartment Radio Advisory Committee, more popularly known as IRAC. Authoritative sources state that many of the frequency allocations proposed by IRAC during the State Department hearings in August will be included in the new frequency program, a program that will not only establish our domestic wavelength schedule, but our international requirements, too.

A MOVE TO ORGANIZE AN FM station on a cooperative basis was initiated recently in New York City. A group known as the Peoples Radio Foundation, Inc., has been formed to build such a station. Thus far there are 28 sponsors in the foundation. They include such personalities as Rockwell Kent, Corliss Lamont, Samuel Novick, Earl Robinson, Charles Chaplin, and Dr. Robert L. Leslie. Recently the group advertised their activities in the local New York City newspapers, declaring that the establishment of a cooperative FM station will provide 12,000,000 people in the New York area with a powerful voice to serve the community and present the advanced thinking of the times.

TRAIN RADIO is playing an important role in the Ordnance Department of the Army Service Forces. Two-way communication systems between locomotives and a central train dispatching point have been operated with considerable success. Experimenting with the system began a year and a half ago at the Savanna Ordnance depot, between the engineer of a locomotive and the train dispatcher at the depot. Today a number of the depots have this method of communication. A distance of 30 miles is usually covered from the dispatcher's office in the depot to the train.

Colonel L. J. Meyns, chief of the Ordnance Field Service Storage Di-

Now You can Use.



ALL OF THESE RADIO PARTS

to help You learn

RADIO

FASTER—EASIER AT HOME

YOU CAN BUILD **133** FASCINATING EXPERIMENTS.

You get *both* radio parts and "Learn-by-Seeing" movies to help you grasp the fundamentals of Radio-Electronics faster . . . easier . . . from DeForest's. Send for DeForest's big, free book "VICTORY FOR YOU!" Learn how—at home—in your spare time—you get real Radio experience with these many Radio parts and sub-assemblies. DeForest's practical equipment system (as pictured above) saves time . . . speeds experiments. You quickly build Radio Receiving Circuits that work . . . a device for Light Beam Transmission. Electric Eye Circuits, a Radio Telephone, and scores of other fascinating projects. Learning Radio at home is practical, effective, and so interesting—with DeForest's "Home Laboratory."

YOU ALSO USE "LEARN-BY-SEEING" MOVIES

Think of the help you can get from the use of this genuine DeVRY Motion Picture Projector and exciting Radio TRAINING FILMS. You'll likely be surprised how much faster . . . easier . . . home movies can help you understand the fundamentals of Radio. SEE the principles of what you're learning—in action. ANIMATED! Peer into moving parts otherwise hidden from the eye.

DeFOREST'S HOME MOVIES HELP YOU LEARN FASTER—EASIER

See Radio Circuits in Action—Electrons on the March—with this genuine DeVRY Projector

DeFOREST'S TRAINING, INC. CHICAGO 14, ILLINOIS

You build and operate these interesting Radio-Electronic circuits in your own home:

5 Tube Superheterodyne Radio Receiver . . . Long-Wave Aviation Band Radio Receiver . . . Short-Wave Radio Receiver . . . Radio Telephone . . . Wireless Microphone . . . Photo Electric Cell Control . . . Vacuum Tube Voltmeter . . . Public Address System . . . Hearing Aid Amplifier . . . Intercommunicating System . . . Radio Code Transmitter . . . Electron Coupled Oscillator . . . Tuned Radio Frequency Receiver and many other projects.

You get the big Radio home-training advantage of movies—exclusively from DeFOREST'S. So act now! Mail the coupon today!

YOU GET "ALL THREE" WITH DeFOREST'S

Where else can you get such a combination of *proved major* training features as—(1) 90 modern, loose-leaf lessons prepared under the supervision of Dr. Lee DeForest, often called the "Father of Radio;" (2) the use of "Learn-by-Seeing" home training films and a genuine 16mm. DeVRY movie projector; and (3) the use of many Radio parts to build 133 practical radio experiments in leisure time.

YOU BE THE JUDGE

See how DeForest's Training has helped many to good pay jobs in Radio-Electronics—others to preferred military classifications—still others to interesting, profitable businesses of their own. See how you can prepare for a bright future now—in your spare time at home—then get started in Radio-Electronics with the help of DeForest's effective EMPLOYMENT SERVICE.

Mail the coupon below for illustrated book "VICTORY FOR YOU"—also colorful Kit Supplement. *You be the judge.* No obligation. Mail the coupon today.

DeFOREST'S TRAINING INCLUDES INSTRUCTION IN MOTION PICTURE SOUND EQUIPMENT, FM RADIO AND TELEVISION



DeFOREST'S TRAINING, INC., Dept. RN-B2
2535-41 N. Ashland Ave., Chicago 14, Illinois, U.S.A.

Please send me—FREE and WITHOUT OBLIGATION—illustrated book, "VICTORY FOR YOU," showing how I can prepare for Radio with your Home Movies and Laboratory Kits.

Name..... Age.....

Address.....

City..... State.....

If a Veteran of World War II Check Here.

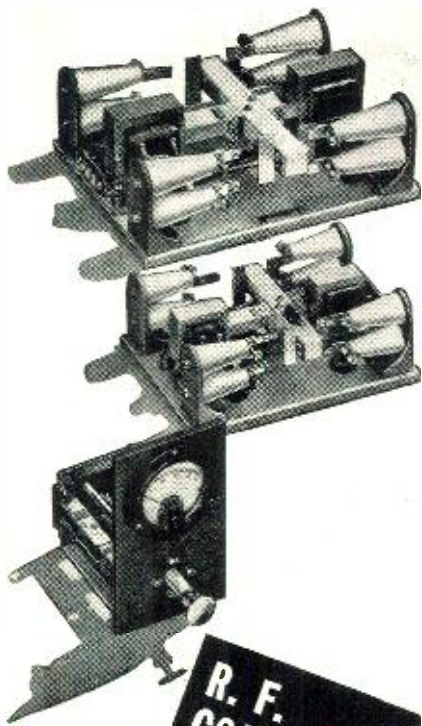

R. F. CONTACTORS
and
M. B. B. SWITCHES

Johnson R. F. Contactors were designed for switching high voltage antenna circuits in Phasing Equipment and for similar applications. Made in two sizes, these Contactors provide long creepage paths, high current carrying capacity, high voltage rating and no holding current is required. They can be operated on either 110 or 220 volt power circuits. Either size is available with a variety of contact arrangements including auxiliary contacts for signal or pilot light indicators. Contacts are sectionalized to provide large contact area and their wiping action makes them self-cleaning. Write today for more information and quotation giving contact arrangement desired.

Johnson Make - Before - Break Switches were designed for inserting and removing meters from antenna circuits without opening the circuit. Features include R. F. insulation, high voltage breakdown rating, high current, carrying capacity, and wiping contacts insuring low resistance.

Ask for Catalog 968 (Z)



JOHNSON
a famous name in Radio
E. F. Johnson Co. Waseca, Minn.

vision, is so enthusiastic about the effectiveness of the system, that plans are being made to equip most of the 193 locomotives in the field service with radio systems. These locomotives operate over 1137 miles of track. Although most of the locomotives are of the Diesel type, no interference troubles are encountered from the large generating units. The Army engineers report that the eddy currents of the generators do not promote interference.

Engineers of the FCC are studying the progress of these systems, believing that the data collected will serve as a guide toward the appropriation of suitable frequencies for train service in the new allocation program.

TWO-WAY COMMUNICATIONS FOR TAXICABS have now become quite practical. In Cleveland, the Yellow Cab Company recently conducted experiments with a fixed transmitter and mobile transmitters in two cabs. Officials reported that dispatching by radio improved travel efficiency and eliminated *dead miles*. All three transmitters were of the FM type, with 15 watts of power. The fixed transmitter was mounted in the top floor of an office building, about 530 feet above the city.

In view of the success of the experiments, the cab officials have requested permanent licenses. About 400 cabs may be equipped with the two-way systems, if the licenses are granted.

BROADCASTING VIA THE POWER LINES is a feature of an unusual collegiate network, the Intercollegiate Broadcasting System, that may soon offer radio networks lively competition. Established some years ago, the system has many colleges in the New England sector and one in Alabama. The system has proved so popular that many major colleges are planning campus stations. Advertisers have also become aware of the interest in this unique network and have begun to sign options for time allotments.

In most instances, installations consist of a master amplifier in a main studio. This is coupled to an automatic turntable, a microphone and a pair of headphones used for monitoring purposes. Microphone and turntable are arranged so that fades between selections, programs or announcements can be made. The output of the amplifier is coupled by a leased line to a master oscillator amplifier, with an output of from 15 to 20 watts. The output of this transmitter is then fed into the wiring circuit of the campus. To receive it is only necessary to tune in a receiver, either standard broadcast or special type, to a prearranged frequency. The frequency may be low, such as 30 kc, or anywhere in the broadcast spectrum.

The USO featured a similar system for camps. And in some of the military camps overseas, similar systems have been installed.

In the collegiate system, both alter-

nating-current and direct-current lines have been used. In one installation, twelve dormitories are linked together via the direct-current lines. In most cases, however, the secondaries of the a.c. transformers fed by a master transmitter are used. Where the power problems are too complex, radiation methods are used. These include a network of fine wires spread over a college campus to form a low power radio field to within a short distance of all student quarters; similar antennas connected by a transmission line with a master transmitter; transmission lines from a master transmitter feeding power into building radiator pipes and lighting circuits; and audio transmission lines to remote transmitters covering one or more buildings.

Some of the colleges included in the network are: Harvard, Yale, Cornell, Columbia, Brown, Wesleyan, Haverford, Bryn Mawr, Union, and Radcliffe.

THE ENTRANCE OF DISTRIBUTORS into the manufacturing business as an additional enterprise was severely criticized recently by members of the electronic distributors industry advisory committee. Members of the committee pointed out that it was not wise to set up new manufacturing facilities, simply because surplus components were on hand. Such parts should be released by manufacturers or distributors who can put them to excellent use.

To provide wide distribution, WPB is sanctioning the approval of many new distributors. Where the request comes from an area well served, the manufacturers have been asked to make sure that the new distributing outlet will materially aid distribution. In screening the applications, WPB is giving particular attention to locations of the new distributors, and the populations they would serve.

THE PRODUCTS OF TOMORROW exposition, in which radio may play an important part appears to be well on its way. The approximate date of March 1 has been set for the opening. And the Chicago Coliseum has been chosen as the exhibition hall. Those who have postwar products that are reasonably new are being solicited. The show is expected to run for two weeks.

Just how many new types of equipment radio manufacturers will be able to exhibit, will depend on war conditions. Some are planning on special experimental models, only. Others believe that new models will be available for such a showing. The success of the radio part of the exhibit will also depend on whether or not the radio trade show, also planned for the Spring, is held. While some manufacturers would probably hold dual showings, many would probably save all their attractions for their own trade show.

The postwar show topic is also being discussed in England. Some experts

Equipped to Surmount NEW PEACETIME PEAKS



AMPHENOL

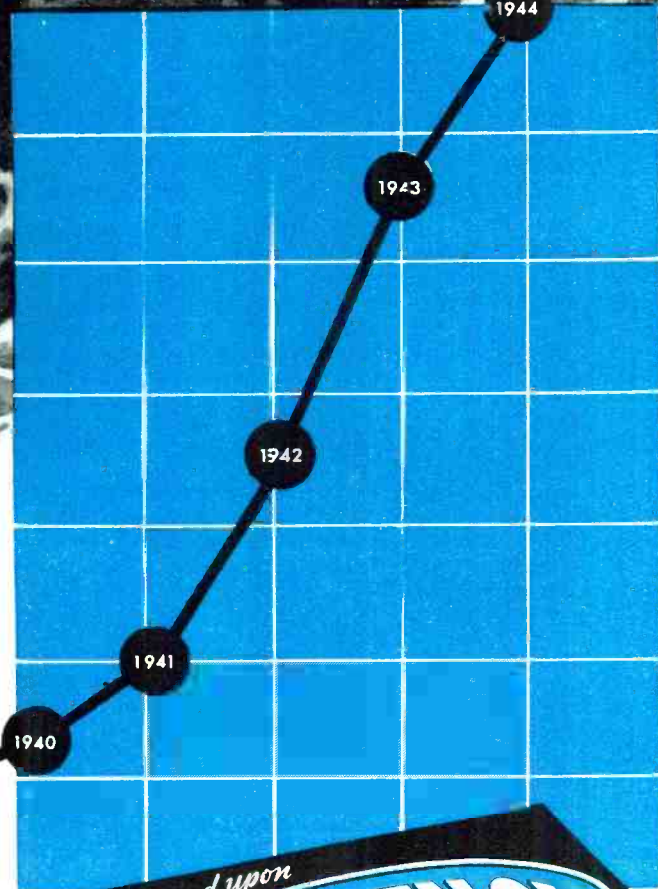

Depend upon

AMPHENOL

Quality

● Up to 1940 when war construction began, Amphenol had a long, proud record of achievement in the production of electrical transmission equipment of the better—more critical—kind. Among other "firsts" Amphenol had developed, and built, the first ultra-high frequency cable.

When production for the Air Corps, Army and Navy demanded precision far beyond that of civilian manufacture, Amphenol went to work exclusively for the Armed Forces . . . will continue working for Uncle Sam until the last bomb burst. When that time comes, the years of experience "under fire", the broadened perspective and knowledge will mean new and improved products, a source of supply of unlimited capacity. This is a rich background of experience in the production of parts for the users of electrical transmission equipment in the electronic, radio and electrical fields.



AMERICAN PHENOLIC CORPORATION, Chicago 50, Illinois • In Canada: Amphenol Limited, Toronto

Connectors (AM, British, U. H. F.) • Conduits • Fittings • Cable Assemblies • U. H. F. Cables • Radio Parts • Plastics for Industry



SUPREME MODEL 571

- Simple Operation — all ranges read on two basic scales.
- Dual Tuning Ratio. One for speed—one for vernier adjustments.
- Electron coupled circuit giving greatest stability. Iron core coils.
- Ladder Attenuator.
- Double shielding minimizes leakage.
- Golden Oak carrying case.

SPECIFICATIONS

R.F. RANGES:
 65-205 KC; 205-650 KC;
 650-2050 KC; 2050-6500 KC;
 6.5-20.5 MC. Harmonics to
 82 Megacycles.

AUDIO FREQUENCY:
 400 cycles available for external
 testing.

INTERNAL MODULATION:
 R.F. Carrier modulated at approxi-
 mately 30% and 70% at 400 cycles.
 Modulation level selected by tog-
 gle switch.

EXTERNAL MODULATION:
 Jack provided for external audio
 modulation.

ACCURACY:
 1/2 of 1% on first three bands. 1%
 on last two bands.

SIZE:
 9-1/2"x8-11/16"x7-3/8"

POWER SUPPLY:
 115 volts 60 cycles—Special volt-
 age and frequency on request.

SUPREME

SUPREME INSTRUMENTS CORP.
 Greenwood, Miss., U. S. A.

there believe that only when receivers and parts are ready for delivery should any show be held. One well-known distributor said that exposing plans and creating demand is dangerous unless the merchandise is available. Such disclosure and unavailability would permit competition to take advantage. Others say that a general show indicating trend of design and engineering will prove stimulating and helpful. Such a show, they say, would spur interest and create sales when all the models are available. It might even be wise to run a second *ready-for-delivery* show, they say.

Since the original announcement by RMA that a Spring radio show may be held, no further information has been released. However the general feeling appears to favor the trend show, if war conditions will permit.

THE RECENT PROPOSALS for subscription-type receivers, which would permit only those with special receivers or receiver adaptors to listen in, has been frowned upon by officials of the National Association of Broadcasters. Objections to such systems were voiced in a letter filed with the FCC. The NAB experts stated that too few frequencies are available for all the services required and in addition, such a system would prompt interference troubles. Programs of wide-spread appeal over as many stations as technically possible will provide the public with the variety they require, stated NAB.

INTRIGUING DATA ON SOUND was presented at a recent meeting of an RTPB panel. Discussing the acoustical noise level, members were told that the average acoustical noise level in residences not having receivers operating was 43 decibels (43 db. above accepted threshold of audibility standard which is .0002 dynes per square centimeter). The average difference between summer and winter values was 3 db., according to this report. Measurements made by W. B. Snow of Bell Labs indicated that the maximum sound level required to be reproduced in the home is 80 decibels. Such a level is so great that it is irritating to listeners with average hearing. Most people will readjust the level so that it falls between 66 and 72 decibels. In view of these requirements, reported the sound specialists, the maximum usable dynamic range for reproduction in over 95% of the homes is 80 minus 30 or 50 decibels. This represents the signal-to-noise ratio that a system should provide.

Charts showing the recommended audio-frequency range for high fidelity broadcasting revealed that above 12,000 cycles, noise predominates over musical tones by a wide margin. Above 10,000 cycles, noise still predominates over musical tones. At 9,000 cycles, those instruments which produce noise and those which produce musical tones are equal in number. And at 8,000 cycles, instruments producing musical tones are predominant. At

12,000 cycles, the violin was classified as providing both noise and music; above 9,000 cycles, the violin, bass clarinet, clarinet, soprano saxophone and piccolo were included as those instruments which produce both noise and music. The cello, bass saxophone, bassoon, bass clarinet, clarinet, soprano saxophone, flute and piccolo offered noise only above 12,000 cycles, while above 8,000 cycles, only two instruments, the French horn and bassoon provided noise. At these frequencies, the snare drum, 14" cymbals, trumpet, oboe, and male and female speech provide a predominance of music, while the violin, bass clarinet, cello, bass saxophone, clarinet, soprano saxophone, flute and piccolo offered both noise and music.

Bell Laboratories experts disclosed that observers at the labs listening to speech in special tests could not detect any change until the full audible range was reduced, in gradual steps from 15,000 to 7,600 cycles. No change was observed for musical reproduction until this full range was reduced to 11,000 cycles. Accordingly, the experts agreed that if at above some critical frequency an equal number of *noise producers* and *musical tone producers* may be considered to offset each other, there is little to be gained by using audio frequencies above 10,000 cycles. As a result they therefore recommended 10,000 cycles as the upper limit for high-fidelity audio transmission for FM broadcasting.

THE RECENT NATIONAL bond drive brought one of industry's old-timers . . . Atwater Kent . . . back to the limelight. Mr. Kent, who was quite a radio magnate back in 1925, purchased \$300,000 worth of bonds to engage Arthur Treacher, the screen actor-butler, as a butler for him at a special party. Many radio and screen celebrities attended the party.

TO GAIN METROPOLITAN RECOGNITION, a station in Brooklyn recently requested that it be permitted to identify itself as of New York. FCC approved the move, wondering though how Brooklyn would feel about it.

THE FACSIMILE SCENE HAS BECOME QUITE ACTIVE these past weeks. Testimony offered by former FCC Commissioner Payne, John V. L. Hogan and other experts at the recent FCC hearings and subsequent engineering meetings seem to have spurred interest. It will be recalled that Mr. Payne, who is now with Finch, advocated the use of multiplexing. He said that entirely automatic record communication for use in the home is available through multiplexing on the band of frequencies assigned to FM broadcasting. Multiplexing operation may also be used on police frequencies, he said, thus meeting the four cardinal requirements, namely, secrecy, orders, finger prints, and identification.

Weather services also could use the
(Continued on page 136)

SPRAYBERRY RADIO TRAINING

Gives you Both



FULL RADIO SET SUPPLIED FOR SHOP PRACTICE!

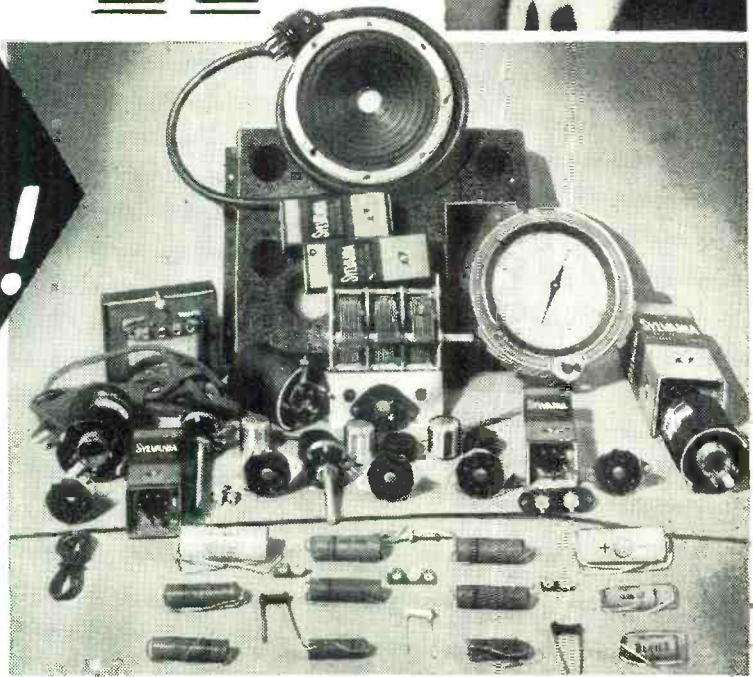

HERE'S THE ONE PRACTICAL WAY TO TRAIN FOR BIG EARNINGS AHEAD IN RADIO-ELECTRONICS & TELEVISION

The offer I make you here is the opportunity of a lifetime. It's your big chance to get ready for a wonderful future in the swiftly expanding field of Radio-Electronics INCLUDING Radio, Television, Frequency Modulation and Industrial Electronics. Be wise! NOW'S the time to start. No previous experience is necessary. The Sprayberry Course starts right at the beginning of Radio. You can't get lost. It gets the various subjects across in such a clear, simple way that you understand and remember.

I'll Show You a New, Fast Way to Test Radio Sets Without Mfg. Equipment

The very same Radio Parts I supply with your course for gaining pre-experience in Radio Repair work may be adapted through an exclusive Sprayberry wiring procedure to serve for complete, fast, accurate Radio Receiver trouble-shooting. Thus under Sprayberry methods you do not have one cent of outlay for manufactured Test Equipment which is not only expensive but scarce.

Prepares You for a Business of Your Own or Good Radio Jobs . . . Civilian or Military

My training will give you the broad, fundamental principles so necessary as a background no matter which branch of Radio you wish to specialize in. I make it easy for you to learn Radio Set Repair and Installation Work. I teach you how to install and repair Electronic Equipment. If you enter the Army, Navy or Marines, my training will help you win higher rating and better pay.

JUST OUT! FREE!

"How to Read Radio Diagrams and Symbols"

... a valuable new book which explains in simple, non-technical English how to read and understand any Radio Set Diagram. Provides the quick key to analyzing any Radio circuit. Includes translations of all Radio symbols. Send for this FREE book now while supply lasts and along with it I will send you another big FREE book describing my Radio-Electronic training.

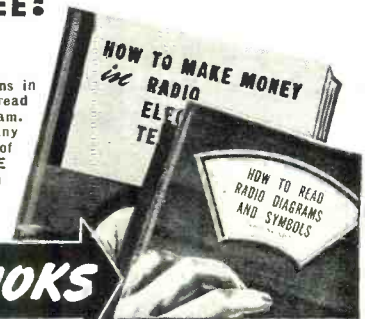

GET FREE BOOKS

SPRAYBERRY ACADEMY OF RADIO

F. L. Sprayberry, Pres.

Box 500-WO
Pueblo, Colorado

Please rush my FREE copies of "HOW TO MAKE MONEY IN RADIO, ELECTRONICS and TELEVISION," and "HOW TO READ RADIO DIAGRAMS and SYMBOLS."

Name Age.....

Address

City State.....

Tear off this coupon, mail in envelope or paste on penny postcard.

New! To facilitate the study of microsecond pulses containing frequency components as high as ten megacycles . . .
TYPE 248 DuMONT
Oscilloscope

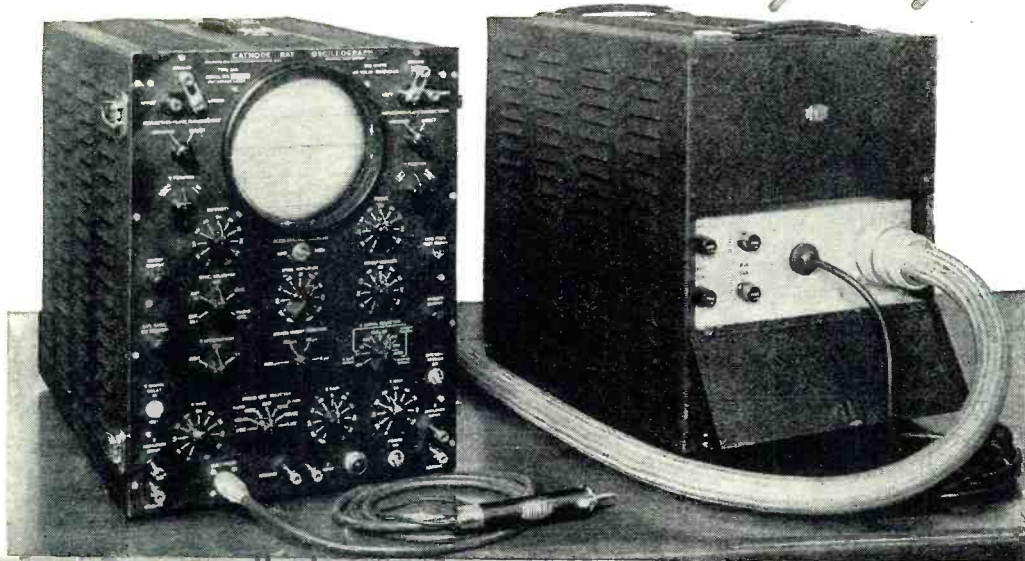

Wide band vertical axis amplifier usable to 10 MC.

4000 volts accelerating potential applied to cathode-ray tube, allowing observation of fast-writing-rate phenomena.

Extremely flexible time-base generator to display signals which heretofore required special sweep circuits.

Delay network in vertical channel, permitting observation of entire wave shape of short duration phenomena.

Useful timing oscillator for quantitative analysis.

Trigger output signal useful for "synchroscope" applications.

Optional low capacitance probe input to vertical amplifier.

Convenient mechanical design which permits placing separate power supply on floor or shelf beneath lab bench.

Storage space for all cables provided in

power unit.

Design is such that modifications to standard specs. can be accommodated to special order in the following respects: (1) Driven sweep durations; (2) Marker oscillator frequencies; (3) Trigger pulse rates.

Both metal cabinets, with carrying handles, measure 14"x18"x21" deep. Power supply weighs 80 lbs. Oscilloscope, 30 lbs. Units connected by 6-foot shielded cable. Standard A-N connectors used.

▶ Still another DuMont "first". Incorporating the most advanced features, this latest oscilloscope is now available at moderate cost as a standard commercial instrument. It will be especially welcomed by the investigator heretofore restricted in his work by the inadequate performance or the prohibitive cost of existing equipment.

Type 248 is a portable instrument. Two units facilitate handling and installation. Either transient or recurrent phenomena can be displayed. Also accommodates phenomena of inconstant repetition rate. The leading edge of short pulses is not

obliterated. The accelerating potential applied to the cathode-ray tube is great enough to permit study of extremely short pulses with low repetition rates, usually observed only with specialized and costly oscillographic equipment. Timing markers are available for quantitative or calibration purposes.

In short, this instrument removes the very noticeable deficiencies in commercial test equipment performance brought to light by recent advances in electronic technique. And it is equally useful as a general-purpose or as a production-test instrument.

▶ Write for Literature . . .

© ALLEN B. DUMONT LABORATORIES, INC.

DUMONT

Precision Electronics & Television

ALLEN B. DUMONT LABORATORIES, INC., PASSAIC, NEW JERSEY • CABLE ADDRESS: WESPEXLIN, NEW YORK





Here all similarity ends...

from this point on, it's craftsmanship!

In one important respect there is a striking similarity between the millions of Bliley crystals which we now produce and the mere handful of custom made units that constituted our annual production when radio was still young.

In those early days of radio, when each quartz crystal was painstakingly cut and ground by hand, a tradition was born. It was a tradition of craftsmanship that has grown with the years—a tradition that Bliley engineers have successfully translated into the more intricate techniques of volume production.

Etched crystals are an outstanding discovery and development of Bliley research engineers. This technique, by means of which crystals are finished to frequency by acid action rather than abrasive action, was an established part of Bliley production long before Pearl Harbor. It has since proven to be an essential element in the manufacture of crystals that have the dependable characteristics necessary for military communication in global warfare.

We have been called upon to solve

some knotty problems. But that is nothing new at Bliley. It has been our habit to parallel new developments in radio with the right crystal for each application.

Things will be different soon. Peacetime projects will again come first. But our engineers and craftsmen will be ready, as always, with the right answer to your requirements. Don't fail to include Bliley crystals in the component specifications for your peacetime equipment.

Do more than before...

buy extra War Bonds



A new star has been added

Bliley
CRYSTALS

BLILEY ELECTRIC COMPANY UNION STATION BUILDING • ERIE, PENN.

February, 1945

21



TYPE 648—Heavy duty dual power pack with parallel output. 300 volts at 200 ma. from 6 volt battery

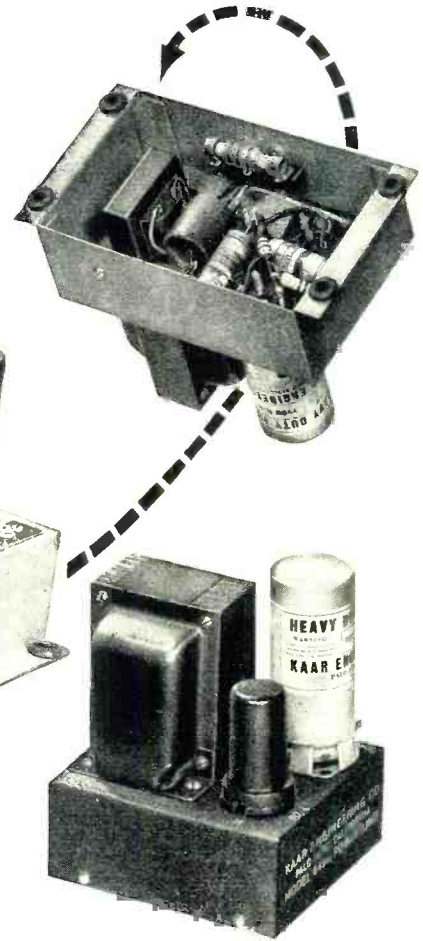

TYPE 650—Standard: 200 volts at 50 ma. Optional: 200 volts at 75 ma. This type available for 6, 12, or 32 volt operation. Has built-in filter. Notice simplicity of construction.

TYPE 649—Provides 240 volts at 50 ma. Available at other standard ratings, and for operation from 6 or 12 volt batteries. Type 647, not illustrated, provides 240 volts at 75 ma.

KAAR POWER PACKS

- Engineered for
- ✓ SIMPLICITY
 - ✓ EFFICIENCY
 - ✓ DEPENDABILITY

Use this West Coast source for vibrator power packs

Kaar Engineering Company offers prompt delivery of standard and special types of vibrator power packs for operation from 6, 12, or 32 volt sources. In addition, laboratory facilities are available for a variety of power

packs designed to your own specifications.





Take advantage of this convenient West Coast source of exceptionally efficient low-drain packs, designed for simplicity and dependability.

KAAR ENGINEERING CO.

PALO ALTO, CALIFORNIA

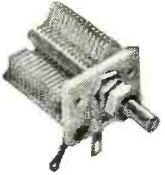

Export Agents: FRAZAR & HANSEN
301 Clay Street • San Francisco 11, Calif.

<p>MOBILE RECEIVERS—Crystal controlled superheterodynes for medium and high frequencies. Easy to service.</p> 	<p>CRYSTALS—Low-drift quartz plates. Fundamental and harmonic types available in various holders.</p> 	<p>TRANSMITTERS— Mobile, marine, and central station transmitters for medium and high frequencies. Instant heating, quickly serviced.</p> 	<p>MICROPHONES—Type 4-C single button carbon. Superb voice quality, high output, moisture proof.</p> 	<p>CONDENSERS—Many types of small variable air condensers available for tank circuit and antenna tuning.</p> 
--	--	--	--	---

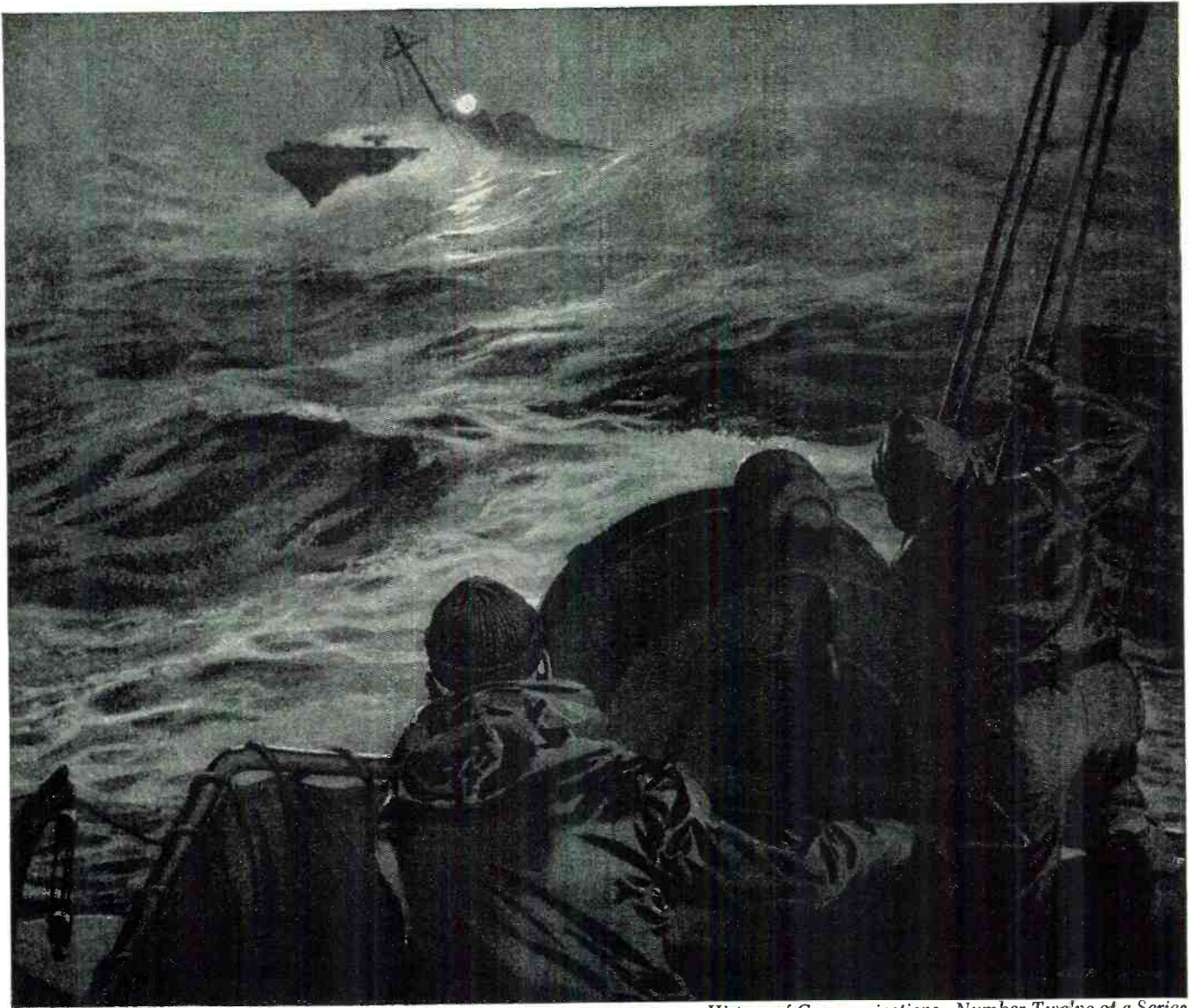

History of Communications. Number Two've of a Series

COMMUNICATION BY THE BLINKER

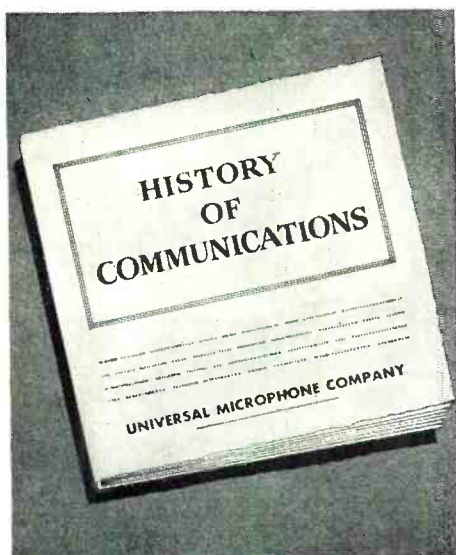

The Blinker, an adaptation of the Heliograph with its own source of light, has been found invaluable for night and day Naval Communications. While limited by "line-of-sight" transmission and the elements of weather, it has been an aid to our cautious convoys during "radio silence."

When Victory is ours and the days of "radio silences" are gone forever, private citizens again will have electronic voice communication equipment for their yachts and other pleasure craft. With the release of civilian radio bands Universal will again offer the many electronic voice components for use in marine craft.

< *FREE—History of Communications Picture Portfolio. Contains over a dozen pictures suitable for office, den, or hobby room. Write for your "Portfolio" today.*



UNIVERSAL MICROPHONE COMPANY
INGLEWOOD, CALIFORNIA



FOREIGN DIVISION: 301 CLAY STREET, SAN FRANCISCO 11, CALIFORNIA • CANADIAN DIVISION: 560 KING STREET WEST, TORONTO 1, ONTARIO, CANADA

February, 1945

23

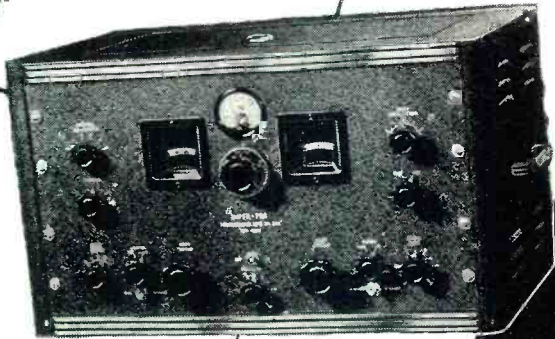

'ROUND THE CLOCK WITH SUPER-PRO

For twenty-four hours of every day
"Super-Pro" receivers are assisting
the "Round the Clock" bombing of
the enemy... In war and in peace
"Super-Pro" leads the field.

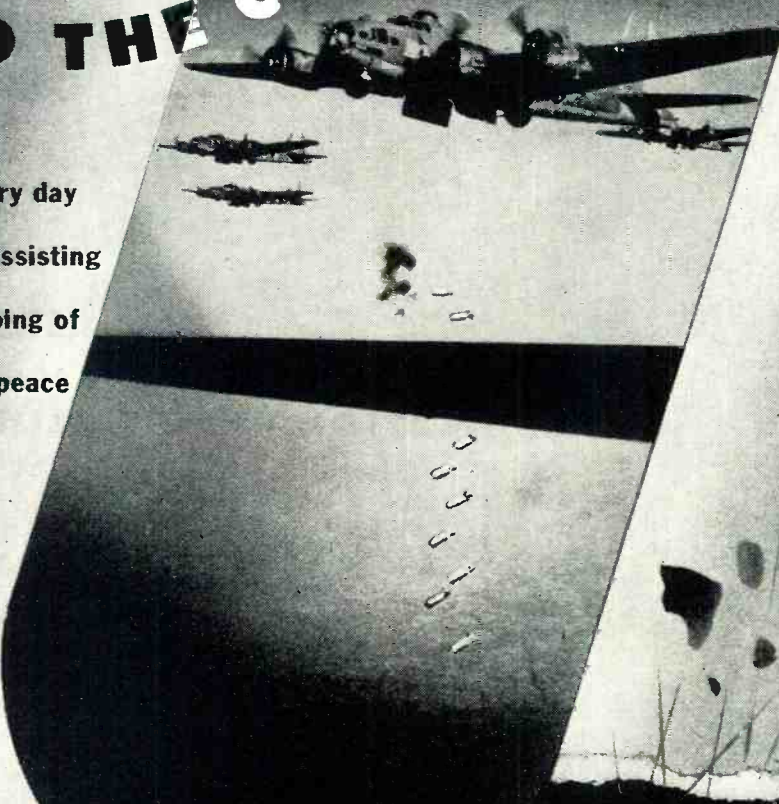

THE HAMMARLUND MFG. CO., INC., 460 W. 34TH ST., N.Y.C.
MANUFACTURERS OF PRECISION COMMUNICATIONS EQUIPMENT

Electronic FLIGHT RECORDER

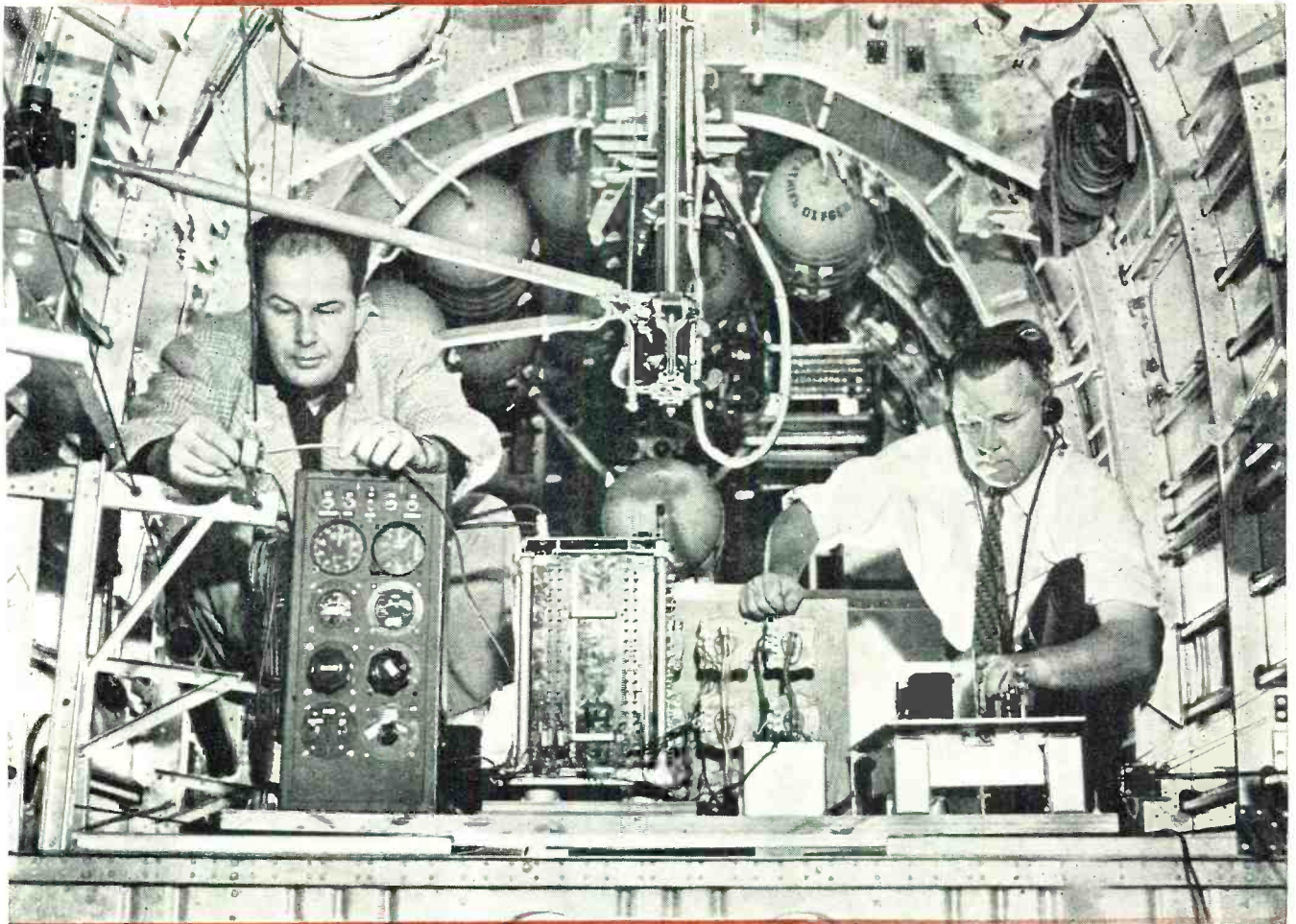

(Left to right) Thomas B. Thomson and Willard C. North, co-inventors of Consolidated Vultee Aircraft Corporation's new "electronic brain," install the transmission unit of their new device in the aft end of a Liberator Bomber.

By
**THOMAS B.
THOMSON**
and
**WILLARD C.
NORTH**

Consolidated Vultee Aircraft Corp.

**Flight test data for all
types of aircraft now is
transmitted to receiving
stations for observation.**

FLIGHT personnel no longer fiddle with pencils, paper whipping in gusty drafts, and temperamental camera equipment when recording the detailed story of an airplane undergoing tests.

In large airplanes, as the Liberator and new Dominator (B-32), it is possible for extra engineering observers to read the dials, gauges and other instruments, and note the results. Pilots flying in the single-seat fighters simply could not fly their airplanes through the many maneuvers and jot down their observations of instruments at the same time. For aircraft, both large and small means for noting flight test data are essential in order that accurate records not only might be obtained under normal conditions, but which will be available for study should disaster strike suddenly.

The answer to this need for all types of airplanes is the electronic flight recorder. The flying part of this recorder, developed over a period

of three years, occupies only four cubic feet of space in the airplane, and weighs only 55 pounds; its ground elements, aside from the pickup, occupy a small room. Together, they contrive to give us accurate, instantaneous data. This is an important feature, for it means, should an accident occur, ground engineers probably can determine why.

Were you to inspect the transmission unit in a Liberator, you would note the equipment includes several pickup or gauge devices, so arranged that airspeed and altitude indications, control surface movements, engine revolutions, etc., produce signals which can be transmitted to a conveniently located mechanism through electrical circuits. Each signal has a predetermined travel or range, and varies with the position of the gauge device. As they pass through a high-speed scanning switch mechanism in predetermined sequence, rate of some 80 readings a second, the varying signals

The aircraft-transmitter portion of the flight recorder is a frequency-modulated Link Type 35-UFM, operating at about 33 mc. and delivering 35 watts to the antenna. Any practical frequency or amplitude modulation could be used, however.

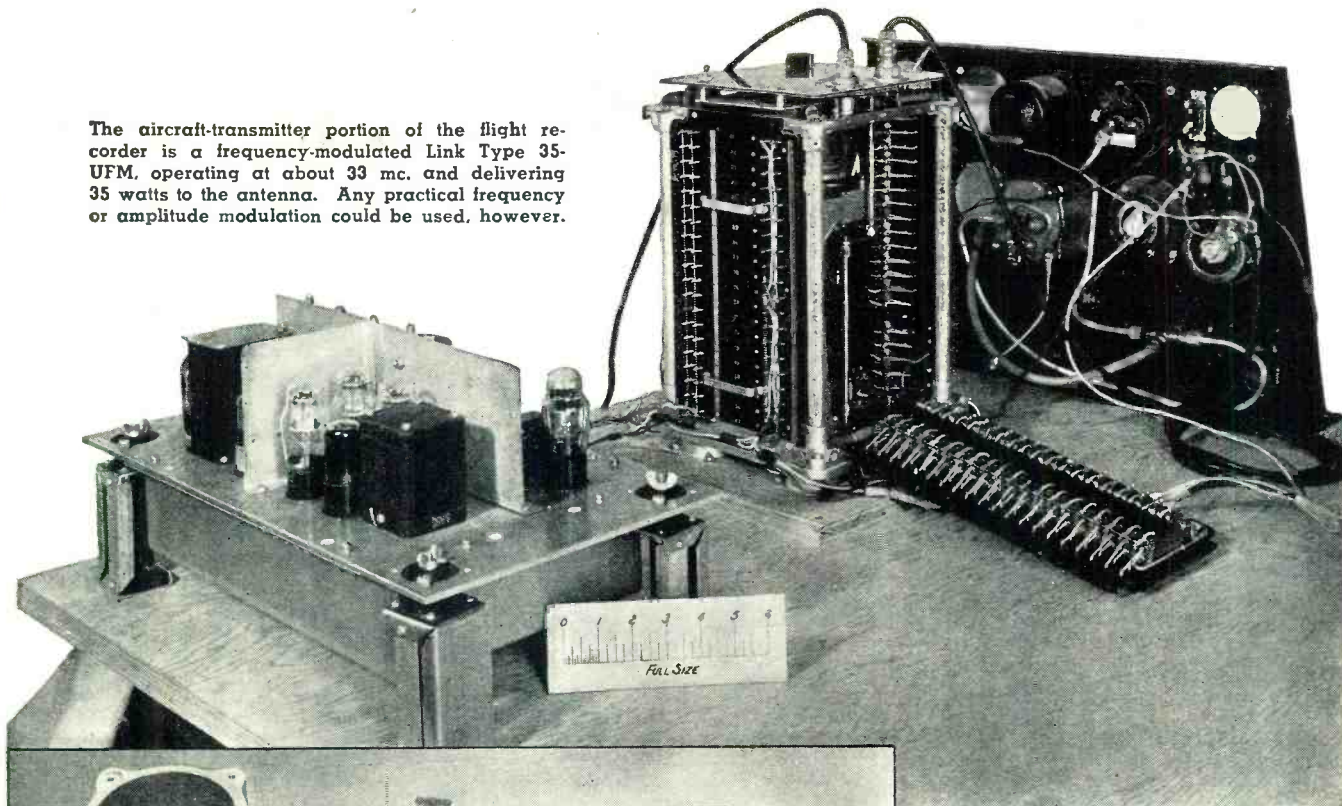

Some of the instruments used in connection with the aircraft portion of the recorder.

modulate an alternating current in conformity with the gauge indications. Then the modulated alternating current is amplified, rectified, filtered, and used to produce an audio-frequency signal. A small FM transmitter broadcasts the signal.

To record this signal, the ground-based receiver is synchronized with the plane's pickup equipment. On receipt of the signal, the receiver decodes the audio-frequency signal by amplifying and converting it to an amplitude proportional to that of the original gauge reading, then utilizing the proportional amplitudes to record the comparative indications of the gauging devices on individual charts.

This is accomplished by a switch, comprising a rotating arm and a series of contacts, which mechanically interrupts the signal at regular intervals. When the arm engages one of the contacts, a potential, determined by the gauge device in the airplane, is fed into the electronic portion of the recording device. A separate electronic circuit, including condenser and electron tube, is provided for each gauge device.

When the potential is fed into the circuit, the condenser is charged to a negative potential. A potentiometer effects the firing of the electron tubes, and it has a slideable contact arm for each of the separate circuits. Movements of the potentiometer arms are synchronized with the movements of the interrupter switch; and, when the arm for a particular electronic circuit moves around the potentiometer a sufficient distance to pass a voltage to the circuit so as to neutralize the previously-mentioned potential or

Schematic shows how the transmission unit functions in connection with airspeed gauge.

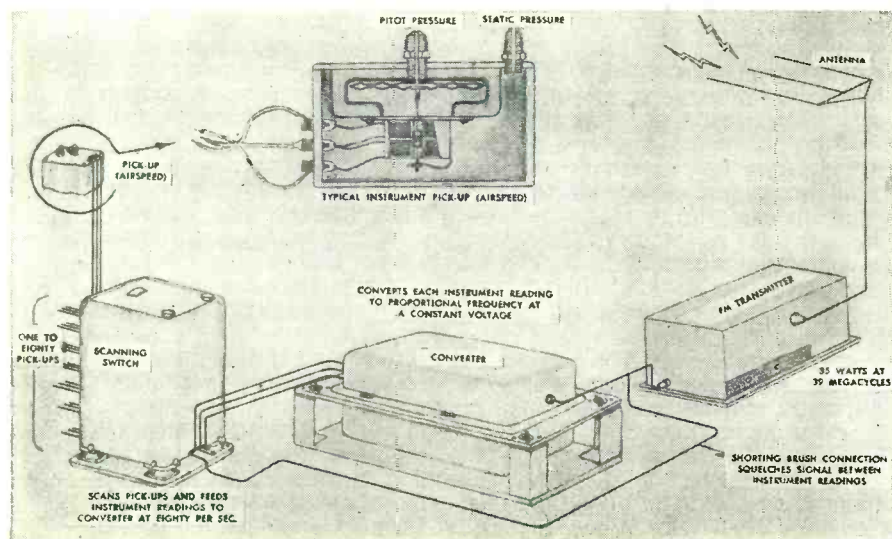

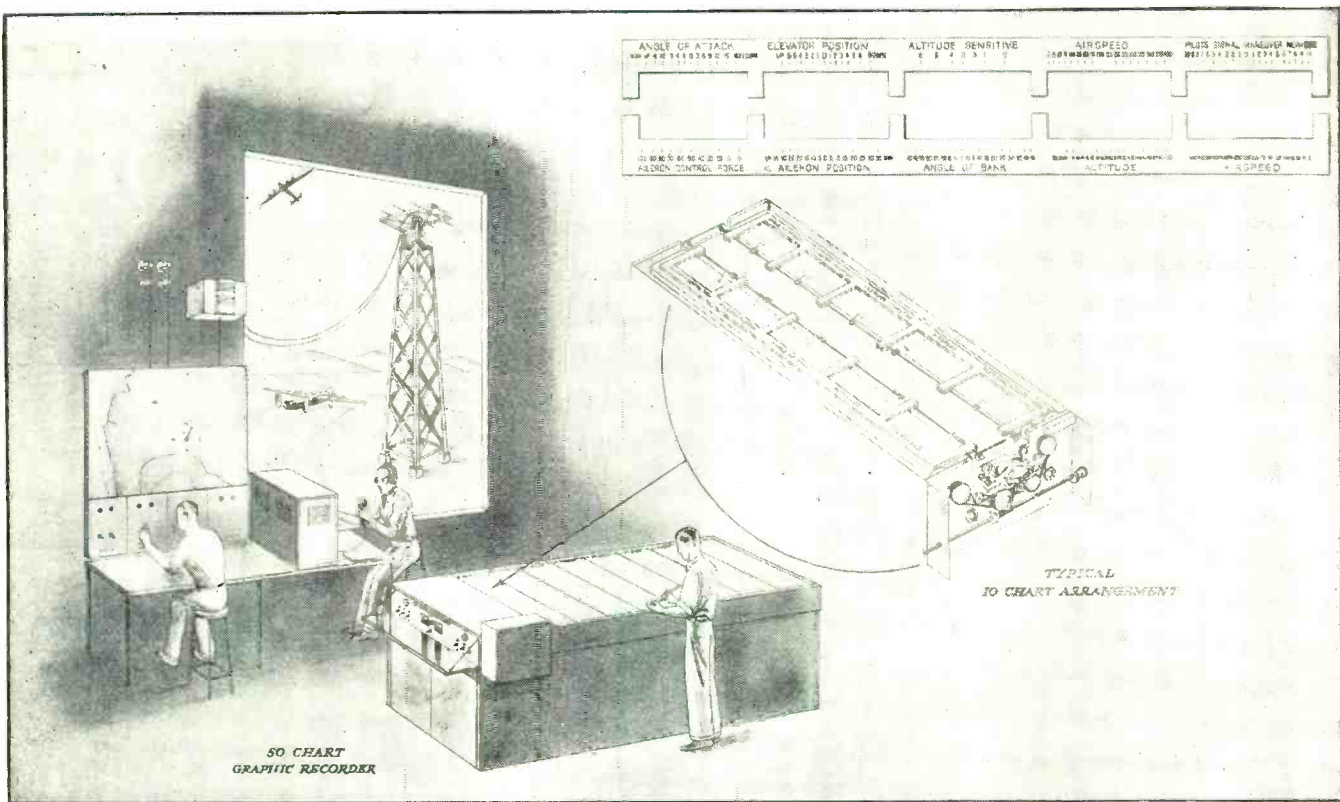

Arrangement of ground portion of flight recorder. Charts provide performance data on aircraft during test flights.

charge on the condenser, the electron tube fires. This action energizes an additional portion of the circuit and causes an electric pen or stylus to make a mark on the special recording paper, which reacts to a passage of current.

The pens move continuously along a track with a wire trolley for contact with their respective circuits. Each pen circuit is actuated at a specific time during its movement across the recording paper; therefore, the potential originally applied to the condenser from the impulse source definitely determines the location of the pen at the time it is energized. The marking pen circuit depends on the firing of the electron tube for its operation, and it acts independently of all other circuits, arriving at the zero point of its operation as a contact associated with the circuit commences its travel on the live portion of the potentiometer.

Marking paper in the recording unit is fed between rollers so that marks will be made by the pens at definite intervals, according to the time that elapses between impulses at the transmitter. This makes it possible to place time lines on the paper, and allows the plotting of two-dimensional graphs with time and position or their ordinates; thus, ground engineers can obtain true reproductions of the movements of gauging devices in the airplane. The graphs can be calibrated readily in terms of airspeed, altitude, positions of control surfaces, etc.

Except for the tachometers, which utilize direct generation, all instruments used in connection with the flight recorder are operated on an

alternating-current bridge principle. The bridge units are divided into three classes: potentiometer, strain gauge, and reluctance bridge. The potentiometers are used primarily for position indicators, as in connection with control surfaces. Normally a 100- or 200-ohm potentiometer is shunted to give the desired range of "off balance." The strain gauges are of the conventional wirewound types,

except that each has a resistance of about 20 ohms. The reluctance bridge is a new-type instrument, specifically developed for use in connection with the flight recorder and may be described as follows:

Two coils are wound, side by side, on a hollow copper or aluminum tube. The coils are about $\frac{1}{8}$ " wide and $\frac{1}{8}$ " deep, and the tube has a
(Continued on page 80)

Ground-based receiver unit is synchronized with the pickup equipment in the plane during flight test, so that it can decode the audio-frequency signal by amplifying and converting the signal to an amplitude proportional to that of the original gauge reading. It then utilizes the proportional amplitude to record the comparative indications of the gauging devices on individual charts.

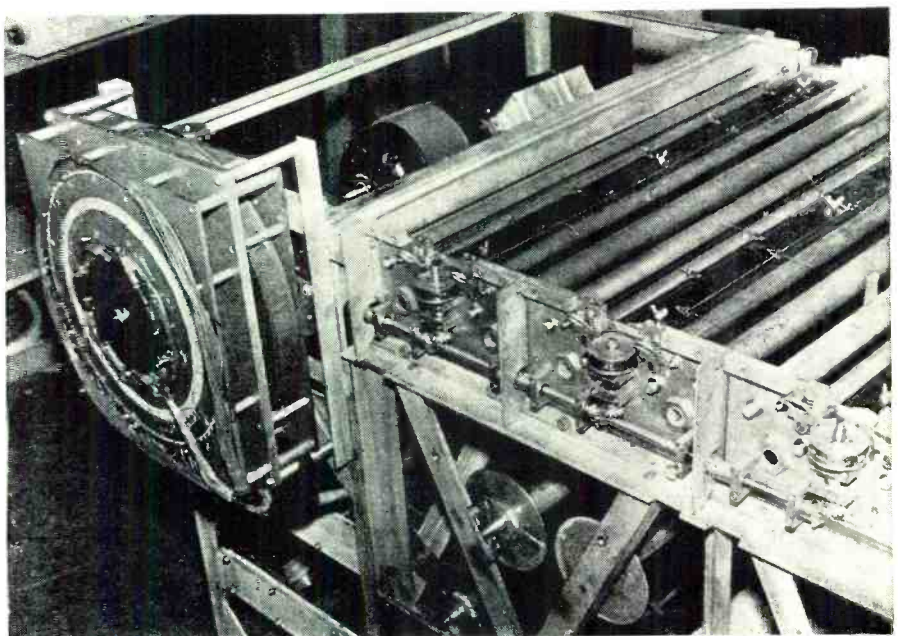

TRANSMISSION LINES AT 200 mc.

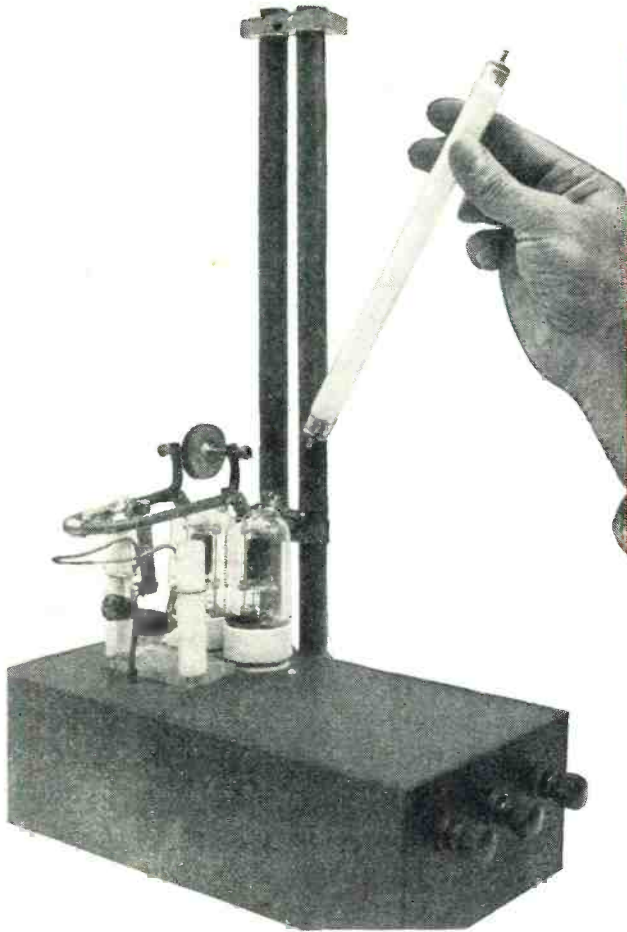

Showing details of oscillator with a 6-watt fluorescent lamp being used as a radio-frequency indicator.

A single dual tube was used in this experiment to study the effects of transmission-line operation. This oscillator is not identical to the one described in the article.

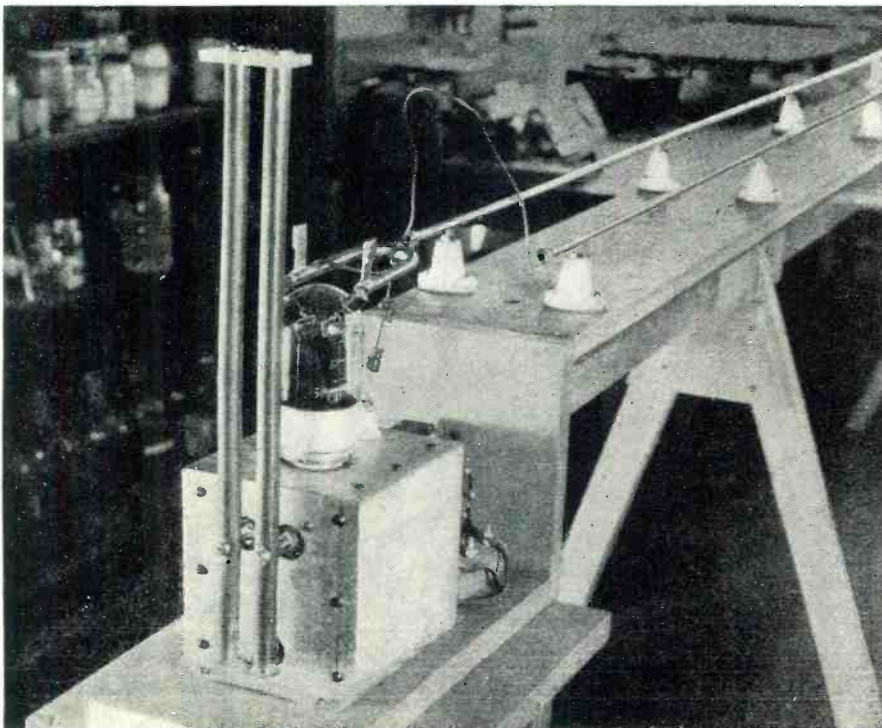

By THOS. A. GARRETSON

THIS is not really a story about transmission lines at 200 mc. only, but applies as well to lines at any frequency. There are no exceptions to this but there are cases where physical realization is impossible. For instance, at 200 mc. a quarter-wave section of line would be 37.5 cm. in length whereas at 60 cycles the same section would be several hundred miles long. So you see that when we attach such a section to a meter it is quite possible at 200 mc. and utterly impossible at 60 cycles.

The transmission line is generally understood to be the connecting link between a source of power and the load which consumes the power. It has, however, when the physical dimensions allow, several other important uses—it can be used as an impedance transformer or as an impedance matching device; also as a phase shifting element and as a Lecher system for measuring wavelength; it can be made to look like a capacitor or an inductor. It is our purpose to show how some of these applications may be utilized.

In order to investigate these phenomena, we constructed an oscillator which would give us a frequency of about 200 mc. or a wavelength of 150 cm. and having an output of 10 to 15 watts. This frequency was selected because it would allow us to build a transmission line several wavelengths long and still keep it down to a reasonable size. For those who may wish to duplicate this work, Fig. 2 is shown giving details of the oscillator's construction.

The plate supply was a standard full-wave rectifier and filter using a type 80 tube. A variac control was used in the primary of the high-voltage transformer thereby making the output completely variable. For a variable power-supply 0-500 volts makes

A general discussion of the basic characteristics of transmission lines — written in a simple, concise manner for the less-skilled junior engineer.

Applying this to our line we have

$$\begin{aligned} Z_0 &= 276 \log (1\frac{1}{2} \times 16/3) \\ &= 276 \log 8 \\ &= 249.2 \text{ ohms} \end{aligned}$$

Other means are available for determining the characteristic impedance when the above can not be used. This might apply to telephone and power lines. It may be well to point out again that the same rules apply to all types of balanced two-wire lines regardless of the frequencies they carry. They also apply as well when the line connects a transmitter to an antenna as when it connects a receiver to an antenna.

Measuring Devices

To make measurements on telephone and power lines, we have the usual a.c. instruments and no difficulty is experienced but when we try to make those same measurements at ultra-high frequencies the problem is different. The region of 200 mc. and beyond approaches what might be known as electrical fantasia. For instance, a wirewound calibrating resistor takes on the appearance of a radio-frequency choke and the familiar resistors used in radio sets may behave like inductors or capacitors. Under certain conditions copper wire will act like an insulator and with microwaves in wave guides the dielectric may take on the dimensions of a conductor.

If we put a series meter in a u.h.f. circuit, we may be adding an inductance or a capacitance and we have no easy way of finding out what or how much we have added. All we know is that our readings are worthless because the added impedance changes the values on the line. Our only hope at present with ordinary equipment lies in using shunt measuring devices of maximum impedance to the frequency being considered. This means that our indicating devices will be in the nature of voltmeters.

Fortunately, we have such a device. A little later you will see that a quarter-wave section of a transmission line, which is shorted on one end and open on the other, offers a very-high impedance looking into the open end.

Strange as it may seem, the shorted bar used to short circuit one end of

the line is not really a short at 200 mc. In other words, a voltage may be developed across it. This voltage may be rectified as shown in Fig. 3, by using one of the crystals of "crystal set" days, and the resulting current may be read on a sensitive d.c. ammeter. A 200 microammeter is a convenient size but a 1 ma. meter will meet most of the requirements. A very desirable feature of this device lies in the fact that these crystals are sensitive to frequencies far beyond 200 mc.

Figs. 3A and 3B show the similarity of the low-frequency a.c. voltmeter and the u.h.f. voltmeter. The low-frequency type cannot be used at high frequencies because of the characteristics of the rectifier. Ordinary crystals such as galena and silicon do not rectify linearly so a calibration curve

a nice unit for general use. If it can not be made variable 300-350 volts is about right. The no-load plate current for our oscillator was about 50 ma. and at full load, 100 ma.

For reasons of stability and durability, 3/8-inch brass tubing was used as conductors of the transmission line (Fig. 7). These were spaced 1 1/2 inches apart and mounted on standoff insulators using as little metal as possible. The antenna end of the line was drilled and tapped to receive the dipole while the oscillator end was fitted with binding posts.

It is desirable to know the characteristic impedance of the line for matching purposes. This impedance may be thought of as the impedance of a unit section of line taken at any point and looking in either direction. It is designated as Z_0 . Numerically it may be found from the dimensions of the line and is:

$$Z_0 = 276 \log \frac{b}{a}$$

where b is the center to center spacing and a is the radius of the conductors. Any units may be used for a and b.

Fig. 1. A Weston thermocouple ammeter (meter B) being used in exploring the transmission line between stub and antenna.

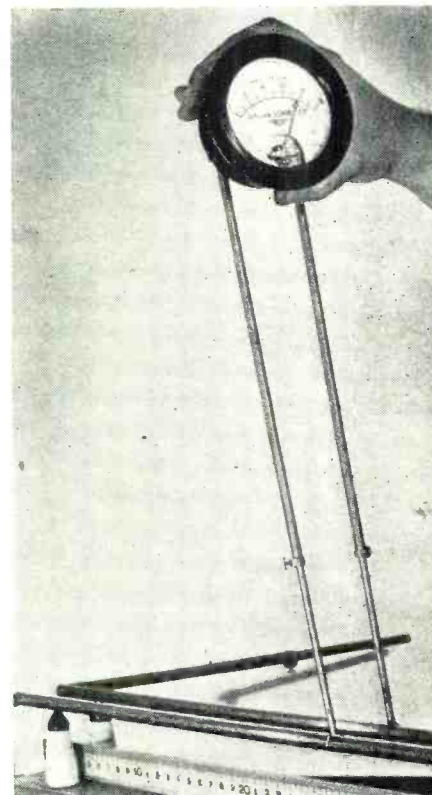

Testing to see whether matching stub has been placed properly to eliminate standing waves, using meter B mentioned in text.



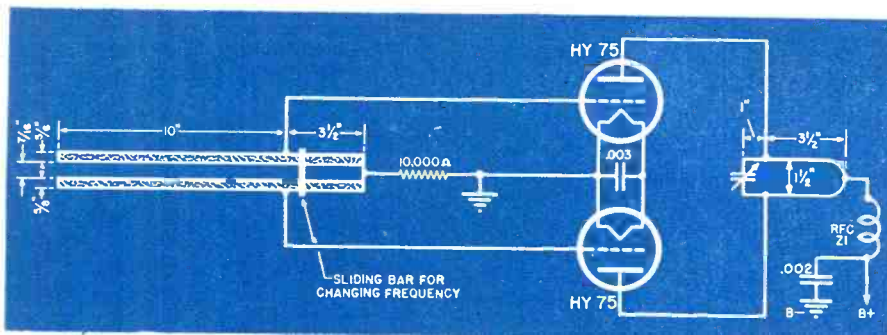

Fig. 2. Diagram of 200-mc., 10-15-watt oscillator. The plate tank coil consists of a quarter-inch copper tubing bent into a U-shape, as shown in the diagram. The plate tank condenser, known as a neutralizing condenser, is 1 1/2 inches in diameter.

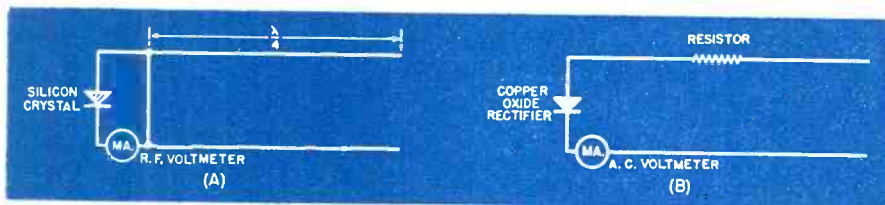

Fig. 3. Method of measuring voltages in u.h.f. circuits (A), and low-frequency circuits (B). It is impossible to use the low-frequency-type meter at u.h.f.

must be made for the crystal used. The method of doing this will be given later. In order to refer later to a meter of this type (shown in Fig. 3A), we will call it meter A.

Another type of meter useful in this work is the thermocouple ammeter. We used in this investigation a 425 Weston, 115 ma. full scale, having a linear scale reading 0-100. This usually is known as a current-squared galvanometer since its readings depend on I^2R . These meters require a correction for high frequencies. We also will use this meter with the quarter-wave section to measure relative voltages. This meter is shown in Fig. 1 and will be referred to later in the article as meter B.

The final type of meter used is a voltage device which is placed near the line, but not in contact with it. It consists of a series circuit containing a 0-1 ma. milliammeter and crystal attached to a probe of variable length. The probe is made variable so that the sensitivity of the device may be changed and also so that it may be used at other frequencies. Used as a

detector it will give some idea as to the amount of radiation from an antenna. This meter shown in Fig. 4 will be referred to later as meter C.

Neon and fluorescent lamps may also be used with good results if sufficient power is available. The fluorescent lamp is especially good for demonstrating voltage conditions on an antenna or transmission line before a large group of people because it can be seen at a greater distance than a small meter.

Open Ended Line

The beginner, trying for the first time to get an understanding of transmission line theory, is very likely to get confused with what appears to be contradictions to all he has learned before. If he will but use what he already knows plus a little logic as he reads the next few paragraphs, he should come up with clear-cut notions of transmission line phenomena. Let us begin by considering an open-ended line, several wavelengths long as shown in Fig. 8, and see what we can find out about it when it is connected

to a source generating sine waves

Since the line is open, the impedance at the receiving end must be a maximum and by the same reasoning, the current must be a minimum. Applying Ohm's Law, we find that the voltage must be a maximum. In trying to figure out the nature of the impedance, we find no inductance at the end of the line but we do have the capacity effect of the two conductors. We conclude from this that the impedance is a high value of capacitive reactance. We now know the conditions (neglecting end effects) existing at the end of a two-wire transmission line.

Next we will review the nature of standing waves. A standing wave is produced when the wave from the sending end arrives at a change in character of the conducting medium. This causes all or a part of the energy in the wave to be reflected back toward the source. This gives us two waves on the line and what we read on meters applied to the line will be the resultant of the two waves. If the original wave was sinusoidal, the resultant or standing waves will be sinusoidal but of greater amplitude. This is to be expected since the resultant wave is the sum of two waves and hence must be greater than either one. The condition which might not have been expected but which is nevertheless true, is that the standing waves produce maximum and minimum values at the same place with respect to the end of the line regardless of the length of a finite line. This makes them appear to stand still.

We can now go back to our transmission line and apply this knowledge. We know what the end conditions are and we have found that the standing waves will be sinusoidal. We need know no more in order to determine what is happening on the remainder of the line. We must make one justifiable assumption and that is that the current is 90° out of phase with the voltage, since our line approaches the "lossless" case.

Let us now examine the conditions at a quarter wavelength from the receiving end. We find that the values of voltage, current, and impedance

Using fluorescent lamp to show that proper placing of a matching stub on a transmission line increases power fed to the antenna.

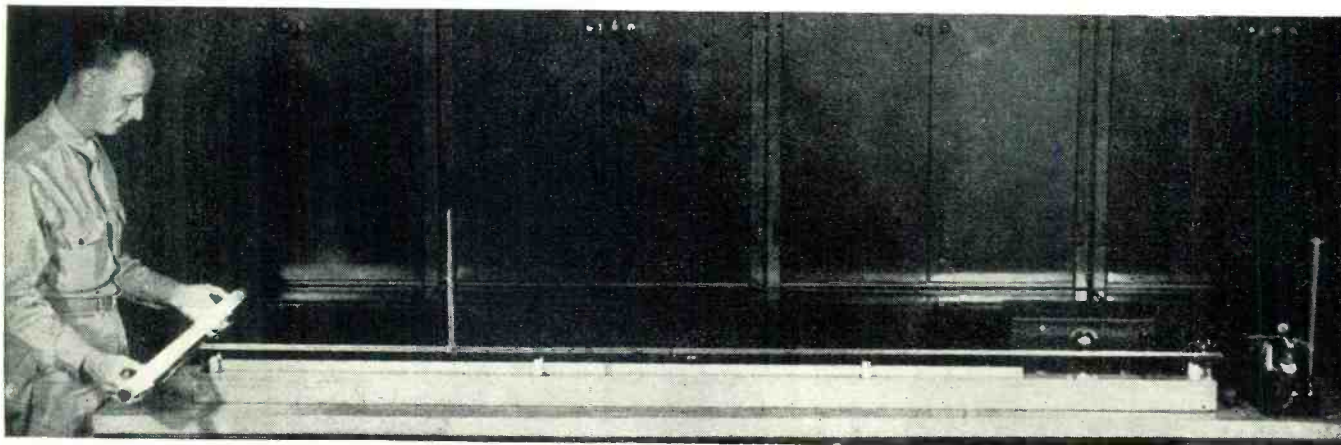

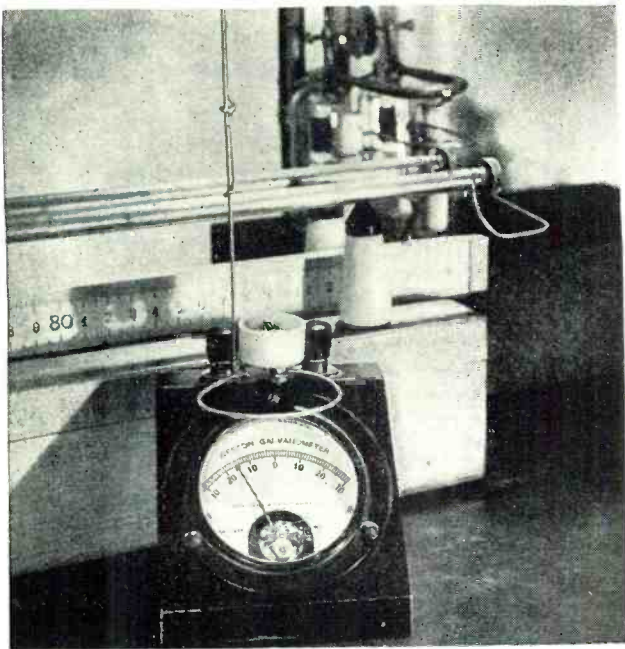

Showing details of generator or sending end of the transmission line. One version of meter A also is shown.

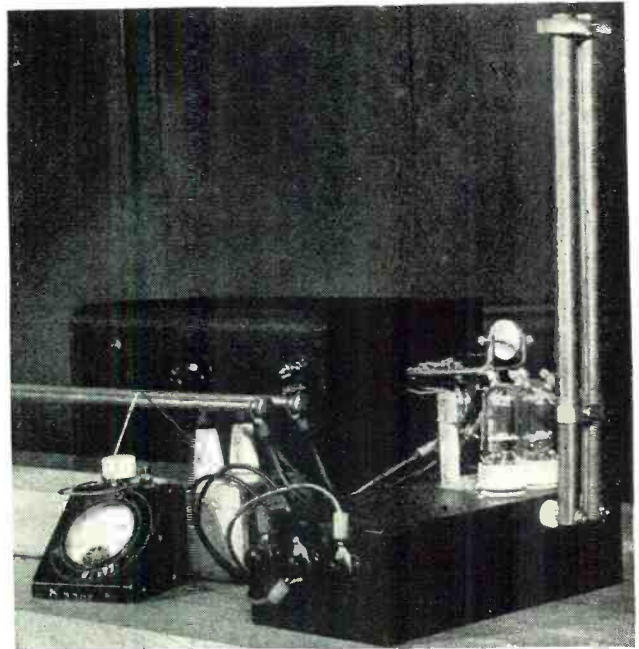

Fig. 4. A 1-ma. ammeter with crystal and variable length probe (meter C) may be used to measure voltages at u.h.f.

have all shifted 90° . This gives us a minimum where we formerly had a maximum and vice versa. We could continue this line of reasoning throughout an entire wavelength but it may be clearer if shown as in Fig. 9A. We know that the current and voltage vary sinusoidally and are 90° out of phase. This could be represented as shown in Fig. 9B.

What about the variation of the impedance? That also can be reasoned out from the knowledge we already

have. We know that $Z = \frac{E}{I}$ and that

E is the sine of some angle. The current being 90° out of phase therefore can be represented by the cosine of the same angle. That gives us a clue to the impedance for by trigonometry we learn that $\frac{\sin}{\cos} = \tan = \frac{E}{I} = Z$. In

other words the impedance variation follows the tangent curve and may be shown as in Fig. 9C.

The impedance at ab , as we see from Fig. 9C, is a low value of pure resistance. But if we look from the open end toward the short circuit it looks like an open circuit or at least an impedance which is a resistance of high value. Here is the case where copper conductors can look like insulators. If we wish to look in the open end and see an open circuit we must use a half-wave section of line. From all this we see that we can get any value of impedance, either inductive or capacitive, by selecting the right length of line. For capacitive values we must use not more than a quarter-wave section while inductive values fall between the quarter and half-wave section, all values repeating themselves every half wave.

To get a picture of the conditions on the line when it is short-circuited at

the receiving end, refer to Figs. 9B and 9C. The end of the line will have shifted 90° to the left and is at the point marked $\lambda/4$. All the wavelength designations shift $\lambda/4$ to the left, all other values remaining the same. The end conditions then become: voltage, a minimum (which is to be expected since the line is shorted); current, a

maximum; and the impedance is a value of pure resistance which approaches 0. All of this is very logical.

Line with Other Terminations

What happens when the line is terminated in some impedance other than those mentioned? Loading the line
(Continued on page 90)

Fig. 5. (A) A method of determining whether the transmission line is properly matched to the load. The line is assumed to be matched when the ammeters read alike. (B) To properly match an antenna to a transmission line, the point of connection can be varied, as shown, until proper match is obtained. The total length of the antenna, including matching section, should be $\frac{1}{2}$ wave or an odd multiple thereof. (C) Another method of matching an antenna to a transmission line is known as delta matching. Total length is $\frac{1}{2}$ wave or an odd multiple and spacing is correct when the ammeter shows no variations along the line.

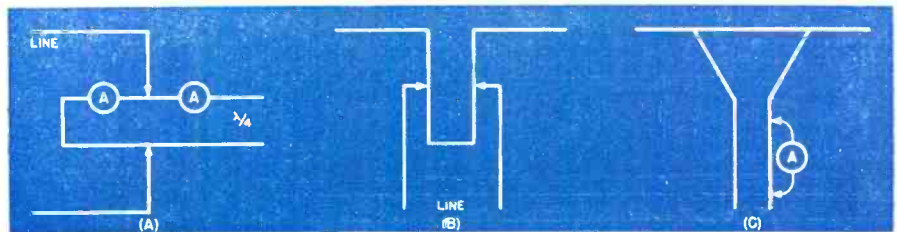
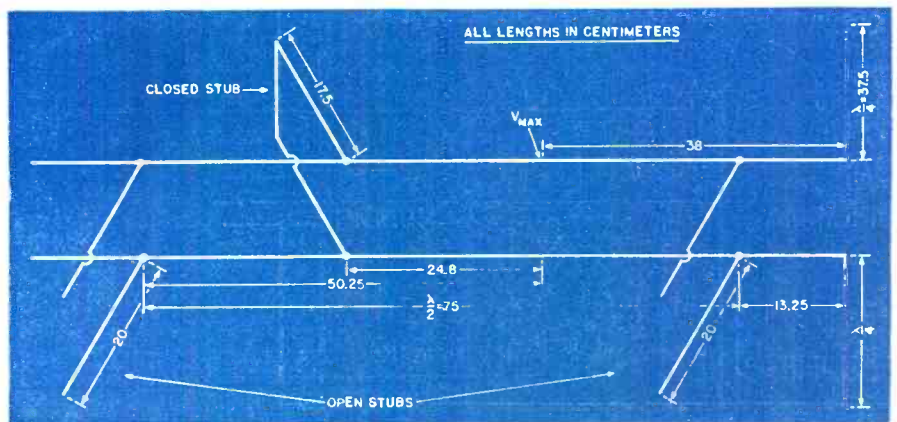

Fig. 6. Results obtained in actually determining the position of the shorted stub when matching a transmission line to an antenna.



Electrical Computing Airborne

Gunsight

By **RUSSELL H. LASCHE**

Director of Engineering and Research
Fairchild Camera & Instrument Corp.

This automatic electrical airborne gunsight takes into account the many variable factors, such as range, altitude, airspeed, angular velocity, etc., which affect the flight of a bullet.

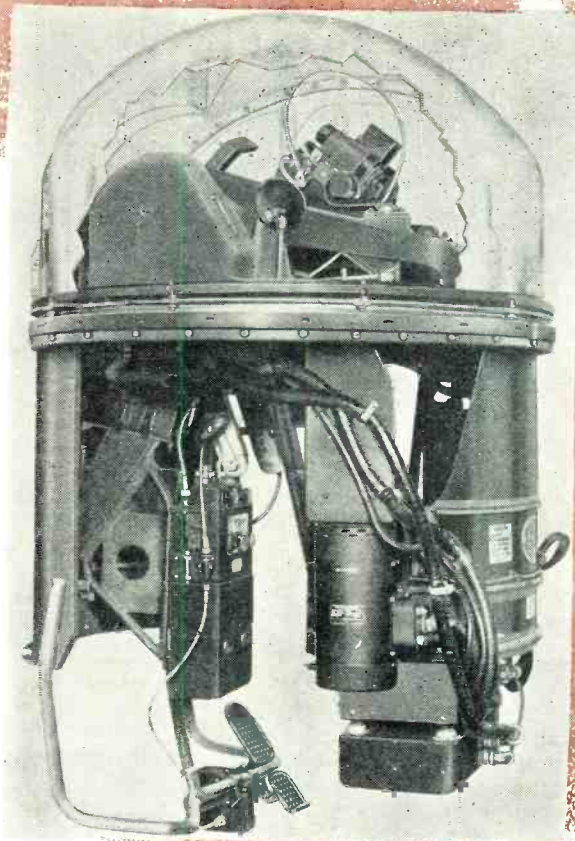

Fig. 1. The computing gunsight with its four components disposed in a revolving upper turret of a bomber. The gunner sits behind the sight component (top), with his foot on the pedal (bottom). Before action he sets three dials on the control panel (just above the foot pedal), recording the altitude and speed of his own ship and the wing span of the target plane (after he recognizes the type). Then he looks through the sight itself—a circle of orange light with a dot in the center. Using the foot pedal to regulate the circle's size, he frames the target from wing tip to wing tip in the circle. The machine then instantaneously makes all the necessary computations; all the gunner has to do is press the trigger. The fourth component of the K-8 is the power unit, nestling out of the way under the gunner's seat (right of the foot pedal).

“YOU may never get the chance again—*don't miff it!*” The words are underscored in the aerial gunner's handbook. In the case of the man who rides in the important top turret of a bomber this job of perfect marksmanship is no longer a matter of trial and error. Guesswork and the undependable human element now are being taken out of his gunfire by an instrument which has been called the “electrical brain,” the Fairchild K-8 Gunsight. Taking into account the many factors which affect the flight of a bullet: range, altitude, air speed, angular velocity, etc., is no longer his responsibility; the K-8 computes them electrically and instantaneously. All the gunner has to do is keep the target within the gunsight's reticle. The instrument does the rest, turning factors into voltages and voltages into mechanical action which gives the guns the proper aim-

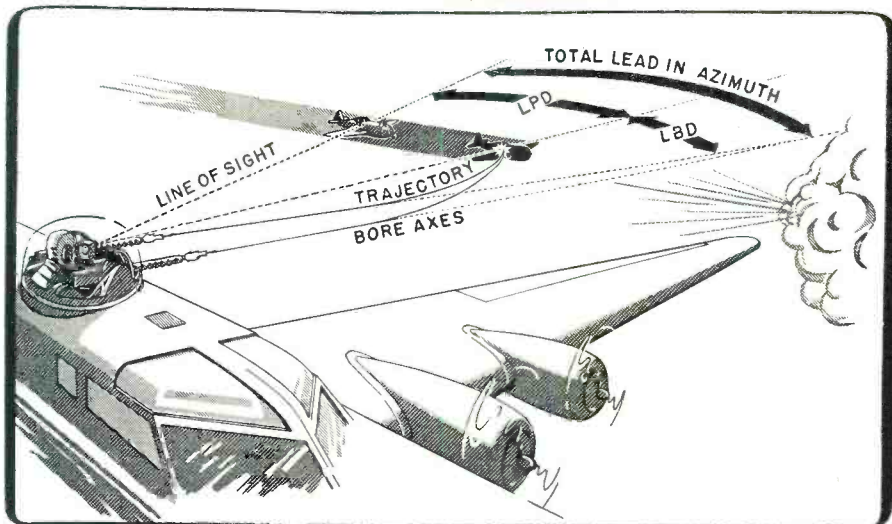

Fig. 2. The Total Lead in Azimuth which is electrically computed by the gunsight.

ing point. Result: rapid and difficult aims now end up in bull's eyes and more enemy planes are getting shot out of the sky.

What the Sight Must Do

Accuracy and effectiveness of a gun-sight depend on the accuracy of the compensation it imparts to the flight of the bullet. To determine this compensation a large number of quantities have to be added, subtracted, and multiplied, and the more factors involved in the instrument's calculations the more accurate are the results.

The final correction given by the sight to the angle of aim of the guns is called Total Lead. This is broken down into two component parts or compensations: Ballistic Deflection and Prediction Deflection, each of which works both laterally and vertically. Fig. 2 shows Lateral Prediction Deflection (LPD) and Lateral Ballistic Deflection (LBD), which add up to Total Lead in Azimuth; Fig. 3 shows the same in the vertical plane. LPD and VPD compensate for the relative velocity between the target and the bomber and are determined from the product of angular velocity and time of flight of the projectile. Time of flight in turn depends upon the following five factors: azimuth position of the gun, gun elevation, range of the target, indicated air speed of the bomber, and altitude of the bomber. LBD and VBD are the lateral and vertical corrections for the effects of windage, gravity, etc., on the flight of the bullet. They, too, depend on the five factors listed previously, but since there is no exact relationship between ballistic deflection and time of flight, the same factors must be computed separately.

The mechanical computing systems that preceded the electrical were unable to take in all the factors involved. Indicated air speed and altitude, for instance, were left out and only two of the remaining factors could be used at a time in a given computation. With the electrical computer all variables can be included. Another advantage is its instantaneous action, of obvious importance when it comes to dealing with target speeds of 300 or 400 miles an hour and bullets traveling at 2,700 feet per second. Also, it is not affected by wear, as is the mechanical sight. In the latter there are many gear systems whose teeth eventually become eroded through

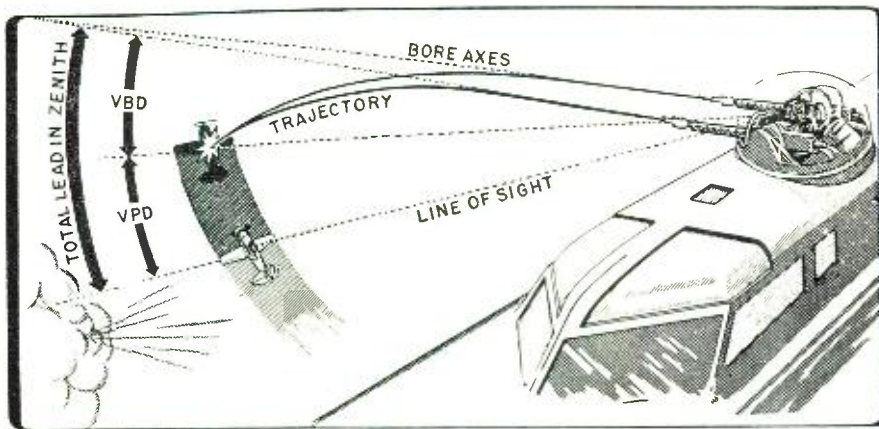

Fig. 3. The Total Lead in Zenith which is electrically computed by the gunsight.

friction and lose their smooth interlocking, with consequent backlash and necessity for adjustment. Lastly, the various component parts of the electrical gunsight, with their connective wiring, can be disposed in the gun turret wherever is the most convenient for the limited space—under the gunner's feet, beneath the seat, or between his knees, leaving only a small piece of equipment in front of his face for greater visibility. Fig. 1 shows the equipment mounted in a gun turret.

The K-8 gunsight, whose development started in 1938 in the laboratories of the Fairchild Camera & Instrument Corporation of New York, and which has been in use by the Army Air Forces for several months, is the only American-born electrical instrument of its kind. Shortly after its appearance the British also put out one, developed apparently inde-

pendently but containing the same principles. Known as the Mark 2, it is being manufactured on contract by three American companies. The Army calls it the K-15 and the Navy the Mark 18. The advantage the Fairchild instrument has over the British is that the latter, for the sake of simplification, gives only the approximate relationship of the variables involved, whereas the K-8 has achieved with success the whole line of calculations down to the most minute.

Construction

The K-8 gunsight is designed to furnish proper aiming point at ranges from 150 to 1350 yards. It weighs 95 pounds and consists of four units with their electrical cable assemblies and flexible drive shafts.

1. *Sight Head.* This contains the optical system, the sight offset motors

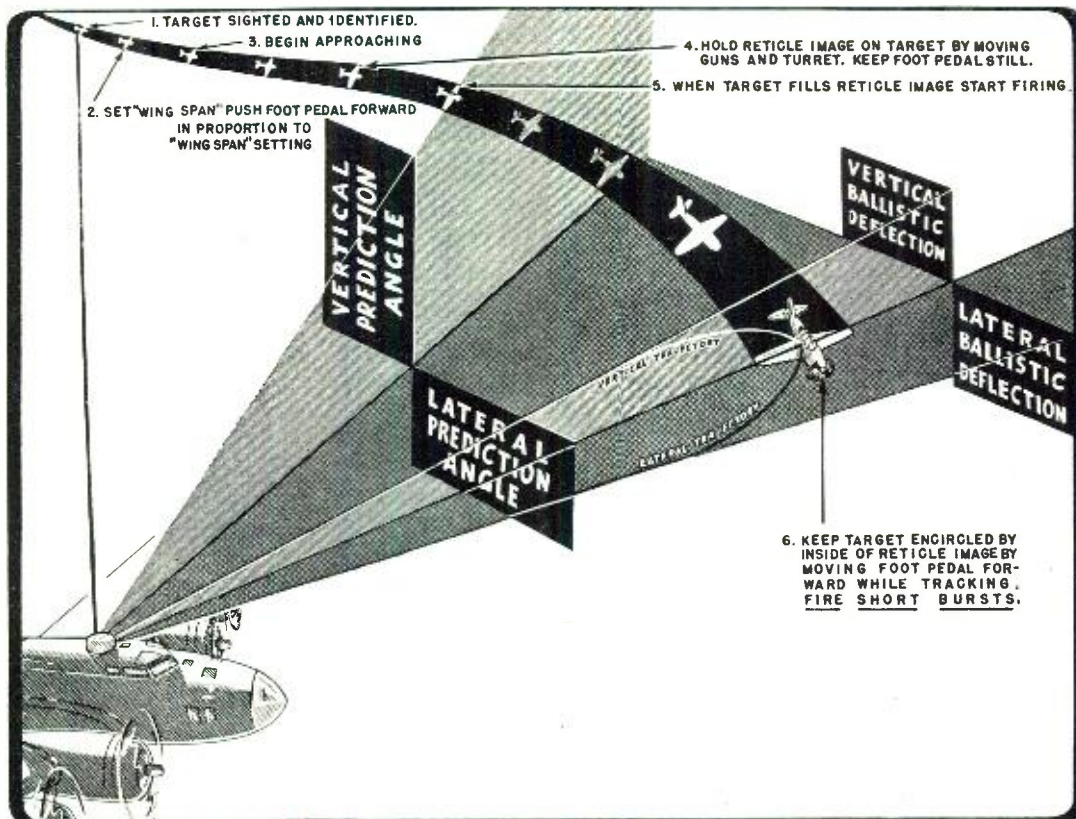

Fig. 4. Illustrating the proper procedure for gunner to follow in firing when employing this gunsight.

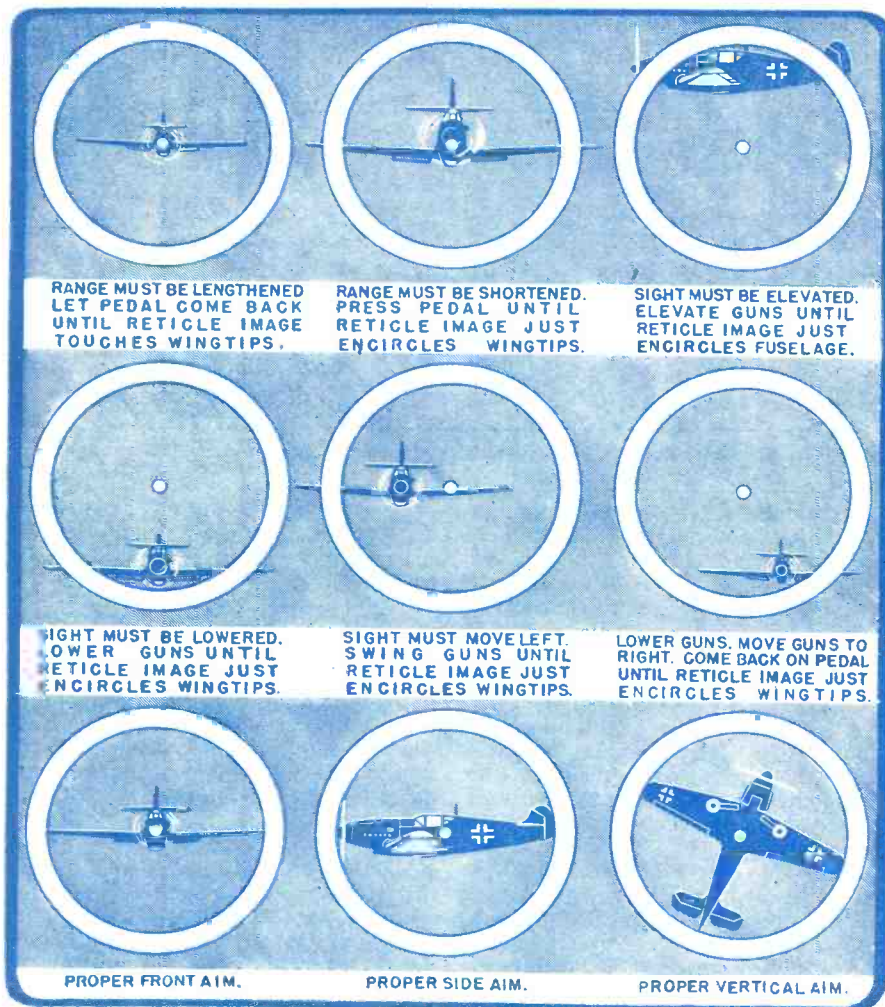

Fig. 5. The optical system of this gunsight employs a solid ring of light in which the gunner keeps the target encircled. Proper aiming procedures are presented.

and the auxiliary generators. It is an electromechanical and optical apparatus for approaching and tracking the target, optically determining range computation and automatically offsetting the line of sight of the guns. It is mounted on a yoke connected by means of a linkage system with the gun elevator sector so that the whole unit can be elevated and depressed

along with the guns. To provide for lateral deflection the sight rotates in its mount which in turn pivots in the yoke for vertical deflection.

Principal part of the optical system is the solid ring of light in which the gunner keeps the target encircled, as shown in Fig. 5. This solid ring is a Fairchild innovation. In some sights the range finder has consisted of two

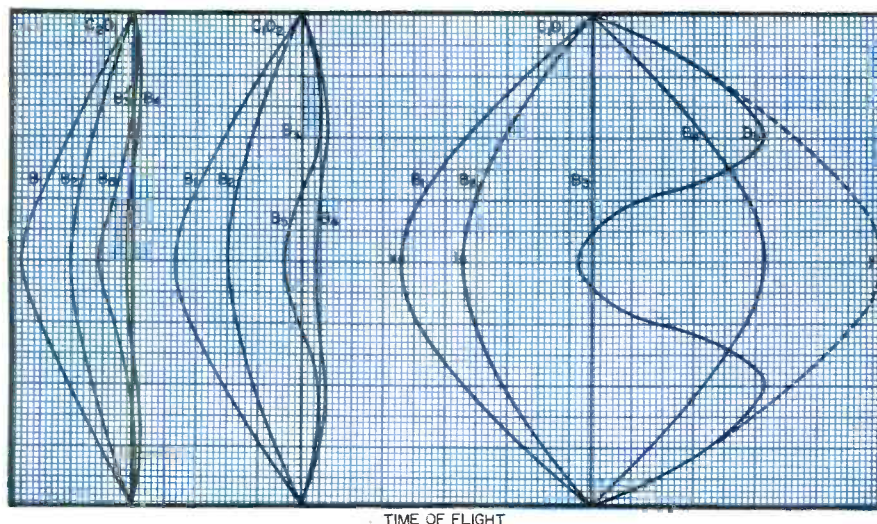

Fig. 6. Three sets of curves that are the result of flight tests and computations, both theoretical and practical. Electrical network is designed from these curves.

vertical lines which could be adjusted in spacing. Here it was difficult to determine the proper range unless the target was horizontal. For other range-finders a ring of dots has been used. This had the disadvantage that, for mechanical reasons, there could be only an odd number of dots (7 or 9) and since there were never, at any time, two dots opposite each other, it was again difficult to estimate the range. The Fairchild solid ring obviated all these difficulties.

There are two motors for offsetting, one for lateral deflection and one for vertical. An auxiliary generator is provided on the same shaft as the lateral deflection motor and is a special feature of the Fairchild K-8. Its function will be described later.

2. *Computer Unit.* The computer unit is mounted between the gunner's knees, unobtrusive and yet with the controls within easy reach. This unit contains the attenuator network whose function is to solve the problem of computation and give the correct electrical answer in the form of the right voltage for each given condition. It also contains reversing switches and velocity generators—the latter connected by flexible shafts with the turret gearing. All controls are indirectly lighted, the brilliance of the illumination controlled by a rheostat. This permits use of the unit under any lighting conditions, which is especially important at night when artificial lighting must be reduced to an absolute minimum so that visibility may be retained.

3. *Power Supply Unit.* The power supply unit, which is under the gunner's seat, contains a balanced d.c. amplifier, a 120-cycle 4-phase alternator, six permanent magnet generators and the motor for driving them and the alternator. The generators are of a special design, with two windings and a commutator on each end of the shaft to provide two d.c. voltage outputs per generator. Four generators supply the computing network, providing the various voltages which are acted upon by the computer unit. A fifth supplies the B and C voltages for the amplifier and the sixth the instrument's bucking potentiometers. They are magnetized to give the exact voltage in a magnetizing jig especially designed by Fairchild for this particular unit. A single casting forms the common endbell for each of the six generators, thus providing automatic alignment for each gear of the gear train that drives them.

4. *Mechanical Foot Pedal Assembly.* With this the gunner can control the size of the ring, so that its edges just touch the wing tips of the enemy plane. It also automatically introduces the factor of range into the computer unit.

All connections between the various units are electrical, with the exception of the connection to the foot control which is a flexible shaft. As previously mentioned, this gives a large

(Continued on page 122)

WACS at WORK

By
EDGAR F. G. SWASEY
Lt. Col., A. C., Chief, WAC Group

War communications must go through at our Army's wire, radio, and cable center in Washington.

MEMBERS of the Women's Army Corps—235 strong—are keeping the messages of war moving at the War Department Signal Center in Washington, hub of the Army's vast wire, radio, and cable communications system.

Working around the clock in eight hour shifts, the Wacs share responsibility for the operation of circuits to all parts of the globe. This station, the world's most important communications center, handles more than 10,000,000 words daily. Through the Wacs' hands pass messages destined to change the course of battles, to bring reinforcements to tired GI's in the front lines, to send supplies to places where they are desperately needed. Every tank, every plane, whether operating in the remote jungles of New Guinea and Burma, on the European battlefields, or in the icy stretches of Alaska, is only a few minutes from the High Command.

The Wacs are a vital part of the communications force which makes this possible. They carry a heavy burden of responsibility, for a message garbled or incorrectly transmitted might cost thousands of lives or affect the progress of a military campaign.

Wacs are carefully selected for this specialized task. They must have a high Army General Classification Test score, and their loyalty records are minutely investigated. Aptitude tests help to show whether or not each individual has the ability to learn the techniques necessary to handle the complex communications assignments.

For those Wacs showing the proper aptitude, the Army offers courses of instruction as typists, or will help them improve their typing speed if they have had prior training and



Cpl. Colton sorts messages received in perforated-tape form, and decides whether they are to be reprinted for local delivery or transmitted to overseas stations.

experience. Two Signal Corps Schools, located at Camp Crowder, Missouri, and at Fort Monmouth, New Jersey, teach the rudimentary phases of communications skills needed for duty in the Signal Center. The Signal Center itself offers a "postgraduate" course as a part of the program of instruction and job-training that fits into regular operations.

This training, while designed to provide skilled operators for the

Army's needs today, will pay off well for the Wacs in postwar jobs. These women are becoming experts in teletype operation, for instance. They operate high-speed perforators, which translate messages into perforated tapes in which each character is represented by a series of five or fewer holes across the tape. The Army has set up an elaborate and highly efficient system for relaying these mes-

(Continued on page 116)

Perforated tapes fed into the transmitters are reproduced by the printers in page form, suitable for delivery to the ultimate addressee. Through operation of this modern equipment, Sgt. McClurg is able to transmit 500 messages per hour.

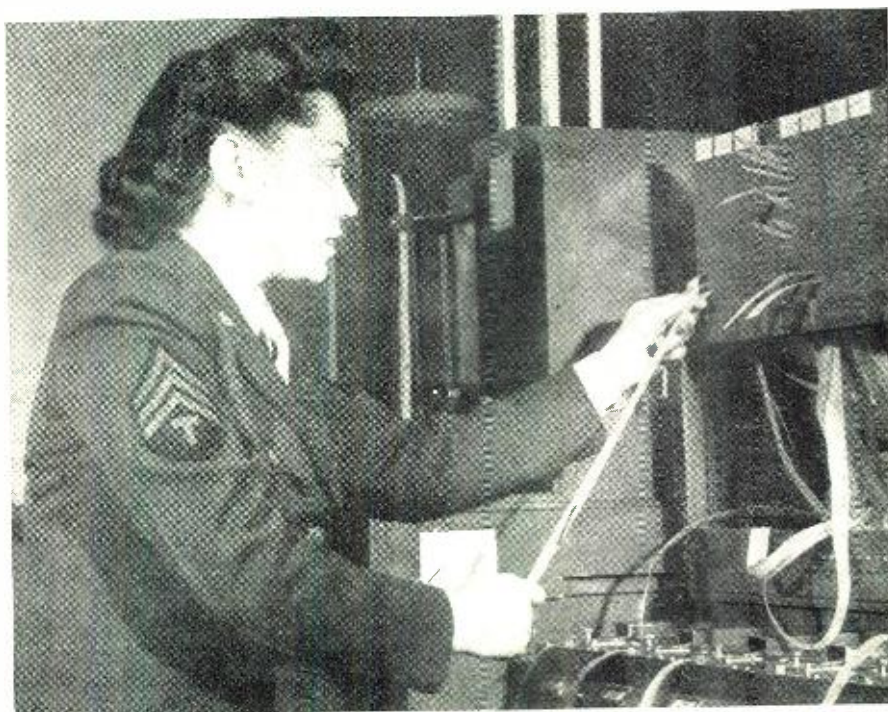



Many of these Servicemen hope to find a place in electrical and electronic fields.

“ELECTRONICALLY YOURS, — G.I. Joe”

By **WILLIAM E. TAYLOR**

Radio Manufacturers Assn.

***The Radio Industry answers soldiers' inquiries
on how to prepare for postwar electronic careers.***

AMID all the worry and talk—a lot of it pretty loose—about the need for “reorientation” of returning soldiers and their future, Uncle Sam needn’t fret too much about one group at least. Communications veterans know what they want to do when they lay aside their uniforms, and they are already taking steps to do it.

Thousands of letters received by radio manufacturers from soldiers in camps and schools and on the fronts show that many are determined to pursue radio and kindred fields as peacetime careers. Their enthusiasm and interest is at a high pitch as a result of the excellent communications training provided by the Army Signal Corps, the Navy, and Army Air Forces, and the superb performance of communications equipment in the combat zones.

A great number of letters ask for information on how the writers may become electrical or radio engineers, and what opportunities the industry foresees for them in the postwar period. Moved by this interest, we have obtained from some of the leading radio and electronics manufacturers a thorough analysis of the entire electrical engineering field, with suggestions on how to proceed, for soldiers wishing to enter it. But first let’s have a look at a few of the letters,

plus a glimpse of radio engineering in wartime.

A large proportion of the inquiries is devoted to television and its development. One ardent student at a Western AAF school asked about television’s prospects, then showed that he had been giving the subject a lot of thought when he submitted a plan for eliminating the “ghosts,” or repetitions of the transmitted image on the receiving screen, which sometimes haunt television when the video wave is reflected from some object in its path.

“Although I am not familiar with the technical details, not having progressed that far in my training, it seems to me that this simple method of transmission would prevent appearance of television ‘ghosts,’” wrote the private to the chief engineer of a large Midwest firm which makes tele-

vision equipment in peacetime, but like all the electronics and radio manufacturers today, is turning out communications apparatus devoted solely to warfare.

The soldier enclosed a neat diagram of his plan. Although the method was impractical for reasons which a radio engineer knew immediately, the fact that he had arrived at it without benefit of an engineer’s training indicated that he had an exceptionally keen mind which could carry him far in the field if properly developed. The chief engineer promptly marked him down in his book as a promising candidate for the research laboratory.

“Send me everything you have about television. I am going to make it my life work,” wrote a technical sergeant from a Florida school, where he is a radar instructor, to an Eastern manufacturer. He disclosed that he was

saving his money, and intended to complete a full electrical engineering course at Massachusetts Institute of Technology, even though he's 32 now and has no idea how old he will be when he gets out of the army.

Primarily because radio is a young man's game—its development began after World War I, and was aided materially by many veterans of that war who had their first contact with radio equipment as Signal Corps soldiers—the industry has been hard-pressed to maintain engineering staffs adequate to meet the vast demands for communications apparatus of World War II.

Although their work is of utmost importance to the successful prosecution of mechanized warfare, since close control of fast-moving echelons by radio is essential and requirements for apparatus change constantly with the types of war and with lessons learned in the field, numerous radio engineers of combat age refused to endure lifted eyebrows of their neighbors, and got into uniform. The services commissioned many for specialized work in signal fields, of course, and these were able to continue research and development activities in conjunction with industry. The Signal Corps itself has estimated that the manufacturers' laboratories have covered ten years' of development in three years' time.

Those engineers who stayed home haven't all led a quiet life in the laboratory. Apparatus must be tested as it is developed, and some of the testing must be done under actual combat conditions. Danger and thrills aplenty are the lot of other engineers who try out equipment for the Air Forces. Riding in the back of the ships, busy with their instruments, they usually don't know what is going on in flight, and judging from the experience of one radio engineer whom we shall call R. E. Joe, it's a good thing.

This engineer had made innumerable flights, always in the back of the planes, and never had become airsick. At last, on a routine test in Nevada, up came his Waterloo. The air was thin and bumpy, and the B-25 hadn't been aloft more than ten minutes before he stretched out full length on the floor, too ill to move.

"Proceed with test," came the radio command from the base. R. E. Joe didn't dare open his mouth to reply.

"What's the matter?" asked the captain of the ship through the intercom. After repeating his question several times, he went back to investigate.

"Go on up and take my seat," the captain told the engineer when he saw his plight. "The back of the ship is the worst place to be in bumpy weather like this. You'll come around all right."

Groaning, the engineer staggered up front. Sitting in the nose, he stared in fascination at the breathtaking terrain unfolding before him for the first time.

"Prepare for dry run," came the order from the base. "Go ahead."

The co-pilot pointed the ship's nose earthward. Down, down, down it sped. The engineer's eyes bulged as a great clump of trees loomed larger and larger. Perspiration rolled down his face, and he found himself pushing backward with all his might against the floor, as a front seat passenger might do in an automobile when a crash seemed inevitable. His airsickness had evaporated.

At last, when catastrophe appeared certain, the co-pilot leveled off, and the plane cleared the treetops by inches.

"Do you always come that close?" Joe asked when he had recovered his breath.

The co-pilot grinned.

"First time I ever made a dry run with a B-25," he replied. "Didn't know much more about it than you did."

The Radio Manufacturers Association foresees innumerable opportunities for electrical engineers in the postwar period, especially in the communications and electronics fields. Widespread development of frequency modulation and of television in the decade after the war ends is expected to open numerous positions for radio engineers both in broadcasting and manufacturing.

Other opportunities will be open to veterans who do not intend to take the time to obtain the training necessary for an electrical engineer. The War Manpower Commission already has noted that communications veterans will have a better-than-average prospect of obtaining good jobs after

the war, listing among them radio repairman, public address serviceman, aircraft radio inspector, radio installer, electrical tester, instrument maker. In some cases, the training already received by the soldier will be sufficient to permit him to enter his chosen field at once. Additional training of various lengths will be required for others.

For the electrical engineering field, this general list of qualifications and requirements should be of help to soldiers interested in such a career. Electrical engineering is broken down into five general headings:

1. Power engineering, embracing generating stations, substations, transmission line and distribution systems.

2. Transportation engineering, embracing generating stations, substations, rolling stock, right of way and signal systems.

3. Industrial engineering, embracing application of power, communications, electronic and special electrical equipment to industrial purposes having to do with processing, remote control, checking, counting, and a hundred operations.

4. Communications engineering, embracing the telegraph, telephone, facsimile transmission, television, radio broadcasting, radio systems for traffic control safety, etc.

5. Electronic engineering, dealing with tubes, photocells, and application of tubes to special electronic devices and services.

Many kinds of engineering work are performed by specialists in each of the fields listed. Among these are,

1. Service and installation engi-

(Continued on page 128)

Enemy "detective devices" being described to Army Air Forces Officers. These men study the equipment so that they will be able to recognize it during combat.



Power Supply Filter Design

By **HAROLD S. RENNE**

Technical Editor, RADIO NEWS

Determining suitable values of inductance and capacitance in power supply filters for reducing the ripple voltage to an acceptable value.

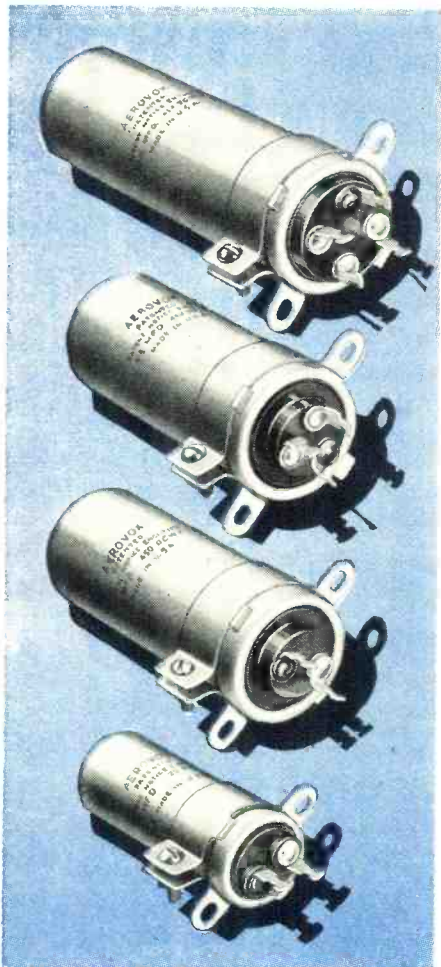

Electrolytic capacitors combine high capacity with small volume.

THE purpose of a power supply filter is to smooth out the ripple in the rectifier output, and so provide a source of essentially pure d.c. Most applications will permit the use of d.c. with a small amount of ripple, the amount of ripple depending on the application.

In order to design a filter intelligently for a particular use, there are several factors which should be known or calculated. Among these are the percent of ripple permissible, the ripple frequency, type of rectifier, i.e., half-wave, full-wave, bridge-type, etc., peak transformer secondary voltage, or the peak supply voltage in the case of a transformerless supply, and the maximum and minimum output currents. These various factors will be discussed as the need arises.

The term "pure d.c." as applied to the output of a power supply is a relative term. The output invariably contains a small amount of ripple, and to describe this ripple properly, a factor called the *percent ripple* is defined. This factor is the ratio of the ripple voltage to the average d.c. voltage

(multiplied by 100 to convert to percent) and is illustrated in Fig. 3. The ripple voltage is the r.m.s. or effective value of the a.c. component in the filter output and may be measured on the a.c. range of a vacuum-tube voltmeter. The average d.c. voltage is the voltage which would be indicated by a d.c. voltmeter. Mathematically, this factor may be expressed thus:

$$\% \text{ Ripple} = \frac{E_R \text{ (RMS)}}{E_{dc}} \times 100 \dots (1)$$

The percent ripple permissible varies widely for different applications. For a high gain voltage amplifier, the ripple should be less than .001%, while for the final stage of an r.f. amplifier for code transmission, 5% ripple is not excessive. For intermediate amplifier stages, ripple should not exceed .1%, and for power stages, 1%.

Ripple frequency is another factor which must be considered in designing power supply filters. As its name implies, the ripple frequency is the frequency of the a.c. component of the rectifier output. This frequency depends on the frequency of the power

Oil-filled capacitors may be used as filter units in applications where high voltages must be filtered.

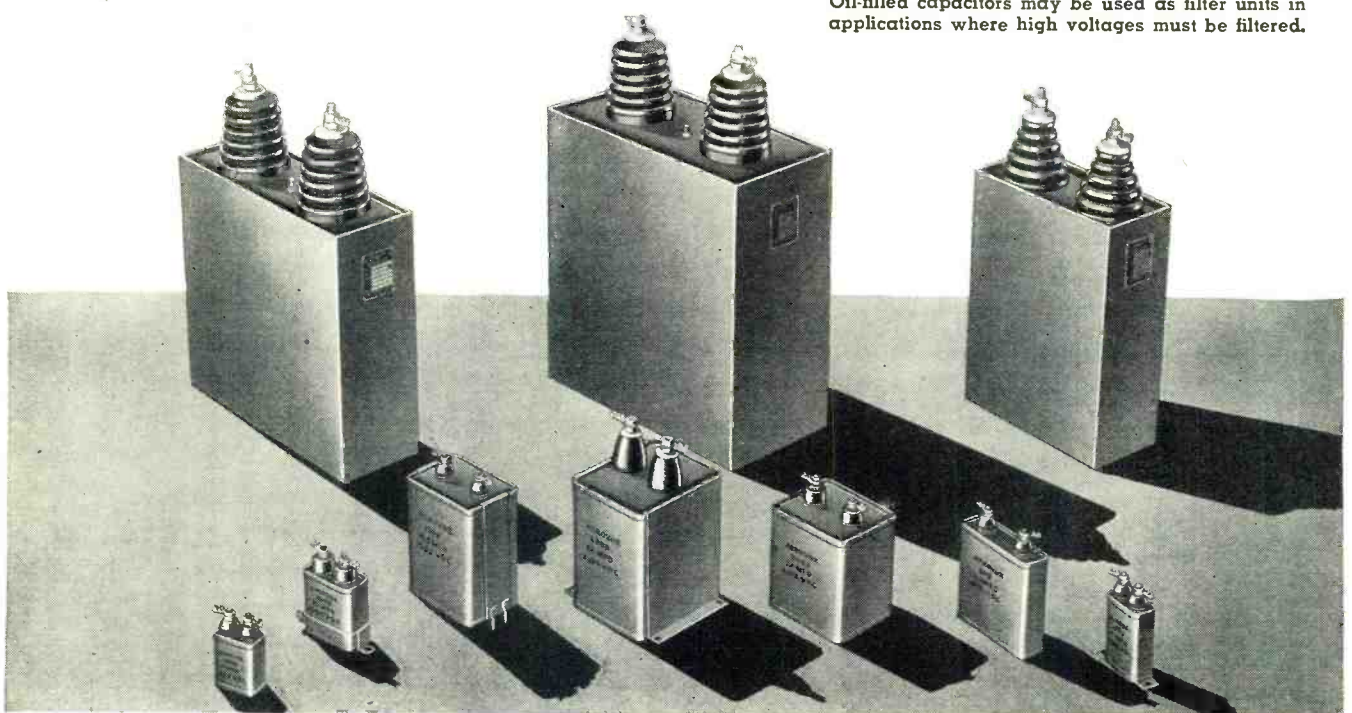



Plug-in type electrolytic capacitors simplify servicing problems.

source, the number of phases and the type of rectification, i.e. either half-wave or full-wave.

The power source for the large majority of power supplies is either single-phase or three-phase. Fig. 4A shows the output of a single-phase, half-wave rectifier. The ripple frequency for such a supply is equal to the supply frequency. Fig. 4B shows the output of a single-phase, full-wave rectifier which has a ripple frequency of twice the supply frequency. The output of a three-phase, half-wave rectifier has a ripple frequency of three times the supply frequency, and a three-phase, full-wave rectifier a ripple frequency of six times the supply frequency. Summarizing, if f is the supply frequency, the ripple frequency for single-phase circuits will be f for half-wave rectification and $2f$ for full-wave rectification. For poly-phase circuits, if n is the number of phases, the ripple frequency will be nf for half-wave and $2nf$ for full-wave rectifiers.

It should be understood that this fundamental ripple frequency is not the only frequency present in the rectifier output. Considerable percentages of various harmonics also are present, but any filter designed to reduce the amplitude of the fundamental ripple frequency to an acceptable value will effectively eliminate all harmonic frequencies.

Power supply filters, in general, are made up of units of inductance and capacitance, with a resistance sometimes replacing the inductance. The effect of the capacitance is to smooth out voltage variations, and the effect of the inductance is to smooth out current variations.

There are two main classifications of filters, depending on whether the element immediately following the rectifier is an inductance or a capacitance. If the inductance comes first, the unit is called a choke input filter; if the capacitance comes first, it is called a capacitor input filter. The two types of filters have different characteristics, and will be treated separately.

A typical single section choke input filter, sometimes called an inverted L section, is shown in Fig. 1A. The

output voltage from a filter of this kind is approximately .9 of the r.m.s. voltage of half the transformer secondary for full-wave rectification, or of all the transformer secondary for half-wave rectification, provided that the inductance of the choke is greater than a certain critical value. The true output voltage to the load will be the above value less the voltage drop in the tubes and choke.

The *critical* value of inductance when the ripple frequency is 120 cycles, is given by the equation:

$$L_{\text{crit.}} = \frac{R}{1000} \dots \dots \dots (2)$$

where R is the load resistance in ohms, and $L_{\text{crit.}}$ is in henrys. Under no load conditions, it can be seen that the value of the inductance would have to be infinitely large, so a bleeder resistor is usually shunted across the filter output, and the resistance of this bleeder resistor determines the highest value of load resistance and so the maximum value of inductance. For ripple frequencies other than 120 cycles, the above value is multiplied by $120/f_r$, where f_r is the ripple frequency. The complete equation is then:

$$L_{\text{crit.}} = \frac{120R}{f_r} \dots \dots \dots (3)$$

With this value of inductance, the

peak rectifier current in a full-wave rectifier will be approximately 10% higher than the d.c. load current taken from the supply.

It can be seen that the value of critical inductance varies widely under varying load conditions, being smaller for larger loads, and *vice versa*. This permits the use of a choke whose inductance decreases as the load current increases. Such a choke is called a *swinging* choke. A choke of this kind is much cheaper than one which keeps its full value of inductance under full load conditions.

Better operation will be obtained under full load conditions if the value of inductance is about twice the critical value. This is called the *optimum* value, and represents the point at which a further increase in inductance does not give a corresponding increase in performance. An ideal choke would be one having critical inductance at no load (bleeder only), and optimum inductance at full load. For example, if the bleeder resistance is 20,000 ohms and the full load resistance 2,500 ohms, a choke which swings from 20 henrys to 5 henrys over the full output current range will be satisfactory. Such a choke would be much cheaper than one designed to have an inductance of 20 henrys over the full current range.

The percent ripple for a single section choke input filter is given by:

Fig. 1. (A) Single section "L" or choke-input filter. (B) Two section choke-input filter. Bleeder resistor R improves regulation.

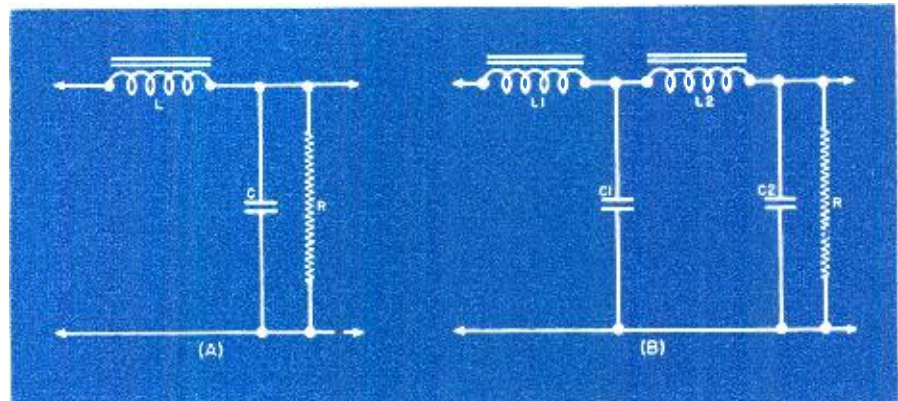
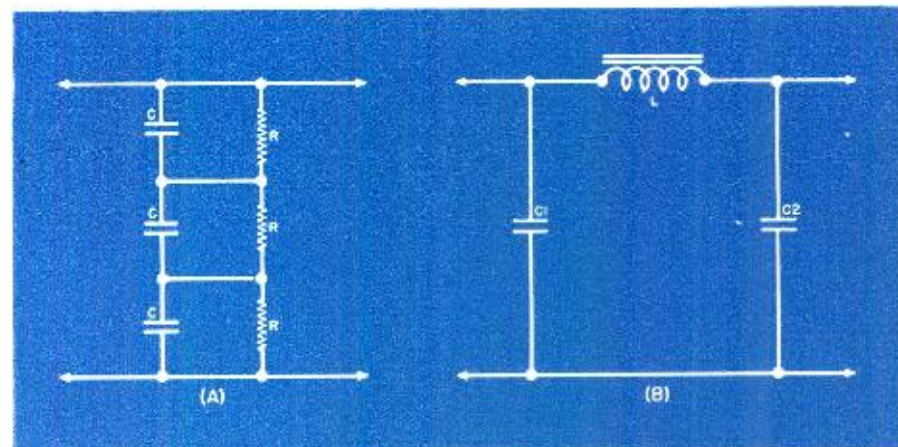
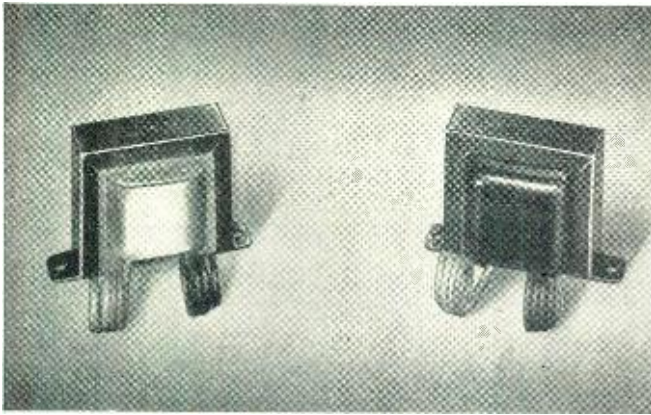
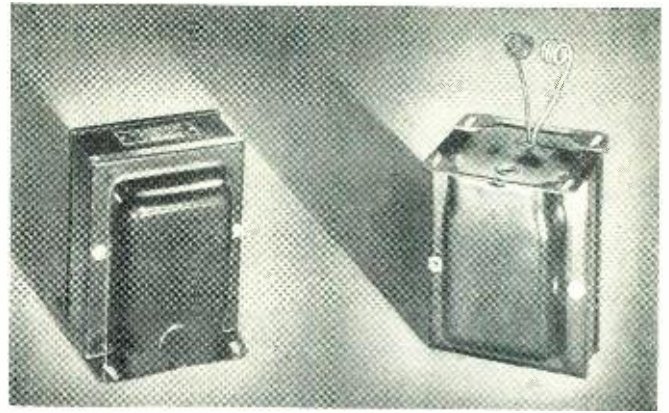

Fig. 2. (A) Filter capacitors in series with voltage-equalizing resistors R. (B) Single section π or condenser-input type of filter.





Filter chokes for top-of-chassis or sub-chassis mounting in low-power applications.



Complete shielding of filter chokes reduces stray a.c. fields and helps reduce hum.

$$\% \text{ Ripple} = \frac{12,000}{LCf_r} \dots \dots \dots (4)$$

where L is in henrys, C in microfarads, and f_r the ripple frequency in cycles per second. If a ripple of less than about 5% is desired, a two section filter may be used (Fig. 1B). The percent ripple is then given by:

$$\% \text{ Ripple} = \frac{7.8 \times 10^4}{L_1 L_2 f_r (C_1 + C_2)} \dots \dots (5)$$

If the filter feeds an audio-frequency power amplifier, the output current may vary between fairly large limits because of the variation in the current requirements of the power tubes. To avoid excessive distortion, the output voltage should be as nearly constant as possible. To hold this voltage constant, the output condenser of the filter must have sufficient capacity to absorb variations in voltage caused by the varying current. The lower the desired frequency response of the amplifier, the larger will be the necessary capacity.

Another way of stating this would be to say that the reactance of the condenser at the lowest audio frequency being amplified must be small compared with the load resistance. If f_m is considered to be the minimum or lowest frequency being amplified in cycles per second, R_L the load resistance in ohms, and assuming that the capacitive reactance may be one twentieth the load resistance, the value of the output capacitor is:

$$C = \frac{10^7}{\pi f_m R_L} \dots \dots \dots (6)$$

Fig. 4. Waveform at output of a half-wave rectifier (A) and full-wave rectifier (B).

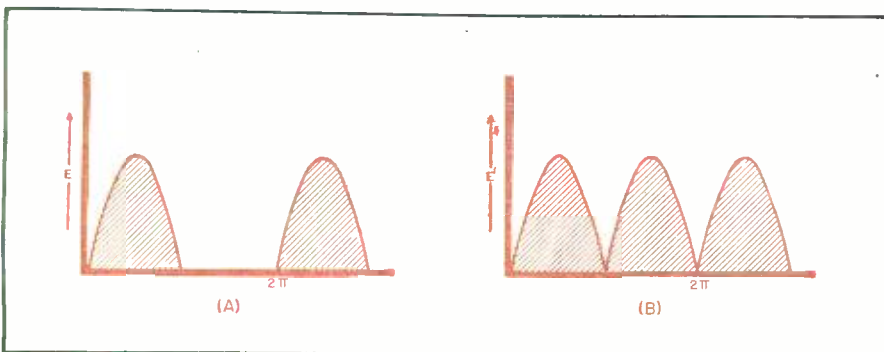

where C is in microfarads. For example, if the load resistance is 5,000 ohms and f_m is 50 cycles, the output condenser should have a value of at least 12 μ fd.

The d.c. working voltage rating of the condenser or condensers used in a choke input filter should be at least

condensers may be connected in series, in which case the voltage ratings are additive (Fig. 2A). The resistors connected across the condensers tend to equalize the d.c. voltage across each condenser. The values of these resistors must all be the same and should be in the neighborhood of one-half megohm.

Condensers having different capacity or voltage ratings should not be connected in series, as this greatly increases the possibility of breakdown. When two or more condensers are used in series, the total filtering capacity is given by C/n , where C is the capacity of each condenser, and n is the number of condensers in series. The voltage rating of the combination will be nE_{wv} , where E_{wv} is the working voltage rating of each condenser.

Fig. 2B shows a single section condenser input, or pi section filter. This is a low-pass filter with a cutoff frequency well below the ripple frequency and is sometimes known as a brute force filter, because large values of inductance and capacitance normally are used without much attention being paid to the actual cutoff frequency. The output voltage of this type of filter varies widely under different load conditions. With no load, the output voltage is approximately 1.41 times the r.m.s. value of half the secondary for a full-wave rectifier, and under heavy loads may drop to .9 the r.m.s. value or lower.

The percent ripple for this type of filter is difficult to calculate, but will be lower as L and C are made larger. A filter design which is suitable for a 120 cycle ripple frequency may be converted for use at some other ripple frequency by multiplying the values of L and C by $120/f_r$, where f_r is the new ripple frequency.

The output condenser for this type of filter may be calculated in the same manner as for the choke input filter (Eq. 6).

The peak value of rectifier current in the condenser input filter is much larger than for the choke input filter, and increases as the size of the input condenser is increased. This ordinarily is not detrimental when high vacuum-type rectifiers are used, but with gase-

(Continued on page 94)

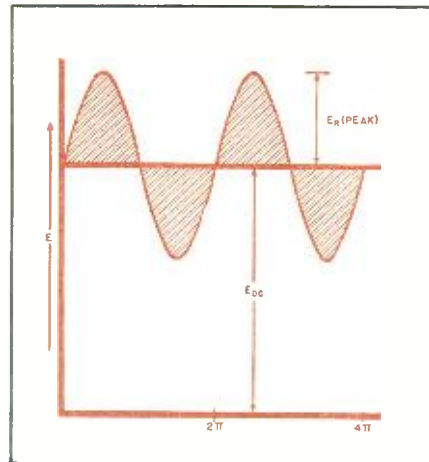
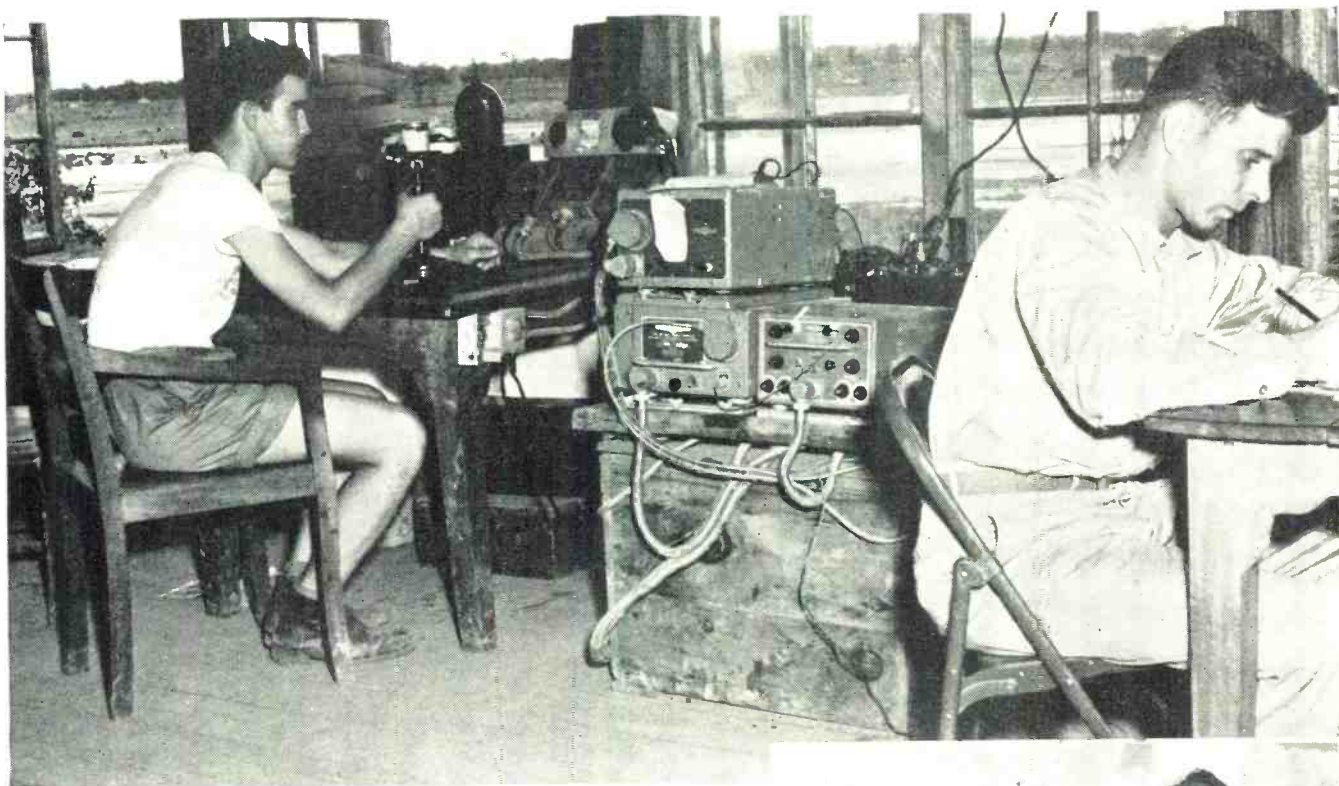

Fig. 3. A.c. ripple superimposed on the steady d.c. voltage.

equal to the r.m.s. value of one half the secondary voltage of a full-wave rectifier. This assumes that the bleeder is connected at all times. If there is a possibility of operation with neither the load or bleeder connected, the r.m.s. voltage should be multiplied by 1.5 to give the required condenser voltage rating. If no condensers of this rating are available, two or more



A Ferrying Squadron Operations Control Tower located in India.

BOMBER'S EARS

Radiomen aboard our bombers must keep in contact with their base at all times, while winging their way over enemy targets.



The departures of all planes leaving either India or China for a trip over the "Hump" are PX'D from this Control Tower to the field where they are to land.

HIGH above Italy a formation of 15th Army Air Force heavy bombers flies to bomb German troop concentrations in a certain town. It's a clear day, and a large escort of speedy fighters makes a protective umbrella for the big bombers. Until they actually reach the target, or encounter flak or fighters, the crew of a bomber takes it easy; it's a "milk run" to everybody but the radio operator, who monitors one of the several radio sets on the bomber, from the time they take-off till they land.

As the bombers roar through the air, 20,000 feet high, the radio operator suddenly receives a coded message from their base—turn back! The radioman on the lead plane repeats the order to the pilot over the interphone.

The formation banks, and heads for home. Back at base they learn that our troops, in a surprise attack, had taken the town the night before. Radio had prevented a horrible "mis-

(Continued on page 88)

Transmitting and receiving equipment at one of our Army Air Forces' outposts. Operators control not only all departures and arrivals, but keep in contact with planes in flight.

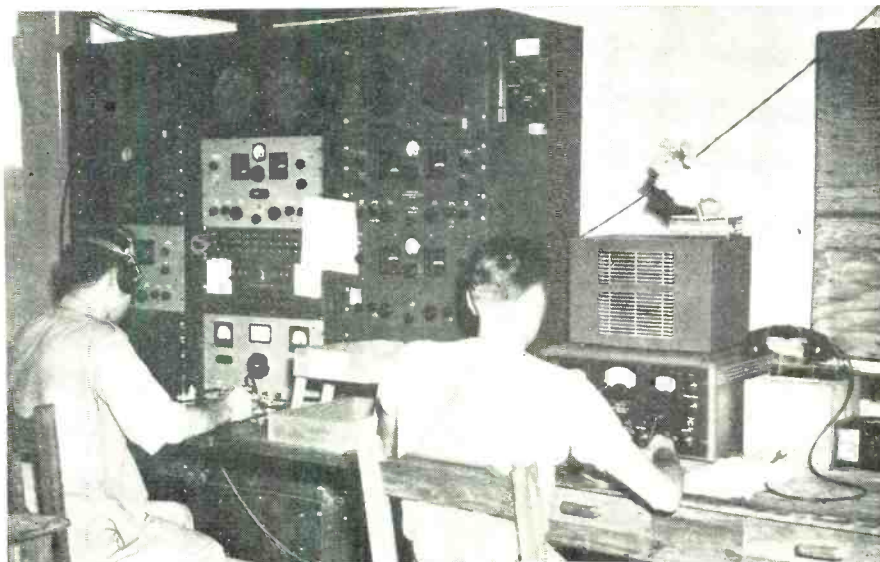

tone control circuits for Phonographs

By F. E. WINTER

A tone control providing a form of equalization may be used to obtain ultimate tonal reproduction from commercial phonograph records.

THE search for better phonograph reproduction leads away from Chippendale cabinet-work to a businesslike assembly of high-fidelity parts. Given a sensitive wide-range pickup, a quiet and smooth-running turntable motor, and a powerful high-fidelity amplifier and speaker team, a phonograph system might be expected to deliver the finest results obtainable from records.

Often, however, such a system sounds quite drowned in a muddy roar of bass. When, in attempting to make the high notes more audible, the operator turns up the volume control, the bass notes break and distort from the resulting amplifier overload and the highs appear intermittently as stabs of ear-splitting resonance. Equalization is lacking, and no setting of tone or volume controls will correct the predominance of bass frequencies.

Due to mechanical limitations of the cutting and reproduction processes, commercial phonograph records are made with their higher frequencies deliberately reduced in scope. Sound waves are recorded by a side-to-side (lateral) undulation, an irregular and often jagged displacement of the groove from its spiral path. To reproduce these waves, the needle point must faithfully trace each minute change of direction in the groove. It is seen easily that groove contortions could be violent enough to throw the

point out of the groove, causing it to rattle or skate loosely along the shoulders of the track. Since the needle point receives thousands of these lat-

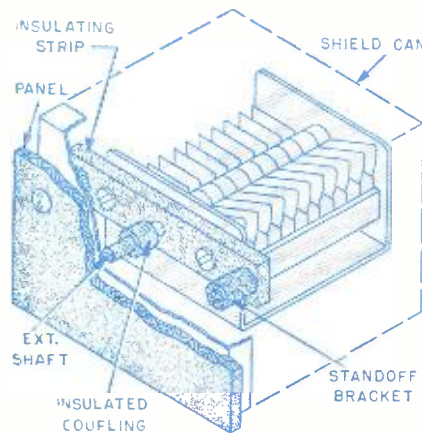

Fig. 2. Showing the method of mounting the variable condenser.

eral impulses each second from the groove track, recording engineers have developed a means for insuring that no movement of the groove will be too quick for the inertia of the needle point to follow. This, the so-called "constant velocity" method, keeps the point in accurate track, except for low frequencies, where constant velocity recording produces so wide a swing in

the groove path that neighboring grooves may intersect one another, and also may be violent enough to toss the point completely out of the groove channel. Here, in the low frequencies, a method of limiting, called "constant amplitude," keeps the groove-swing within safe tracking dimensions.

A commercial recording utilizes both methods to produce a mechanically practical disc, but one result is the great compression or attenuation of higher frequencies and an overabundance of low frequencies, an inaccurate tone picture faithfully and distressingly reproduced by any wide-range phonograph system having an unequalized pickup circuit.

Composed of a few simple parts, the equalizer circuit given here has been installed in phono-systems using amplifiers of various output ratings, designed originally for such purposes as small public-address units, coin phonographs, or wide-range, high-fidelity phono installations. In each case, performance improved remarkably, particularly in the instance of fine, commercially built phonograph amplifiers. Tone of such widely different instruments as the oboe and contra-bass sounded clearly, and at high volume levels the colorful panorama of orchestral voices replaced a previous incoherent roar.

How the Circuit Functions

The bass cutoff is a variable resistance in the familiar volume control form, inserted in parallel with the pickup. The loading applied by this resistance diminishes the low-frequency response of the crystal pickup, to correct the excessive amount of bass present in recordings. Since most amplifiers distort easily on lows, where power output ability can be overdrawn on by too strong an input signal, the cutoff keeps bass tones safely within distortion limits of the amplifier at any volume level and provides compensation for minor variation of bass strength in different recordings.

At low volumes, the control has another application, for, as shown by the frequency graph of Fig. 1, the necessary proportion of bass to middle and high frequencies is much greater at low volume levels. Here, the control

Fig. 1. Curves showing relative proportions of low, medium, and high frequencies for proper reproduction at various volume levels.

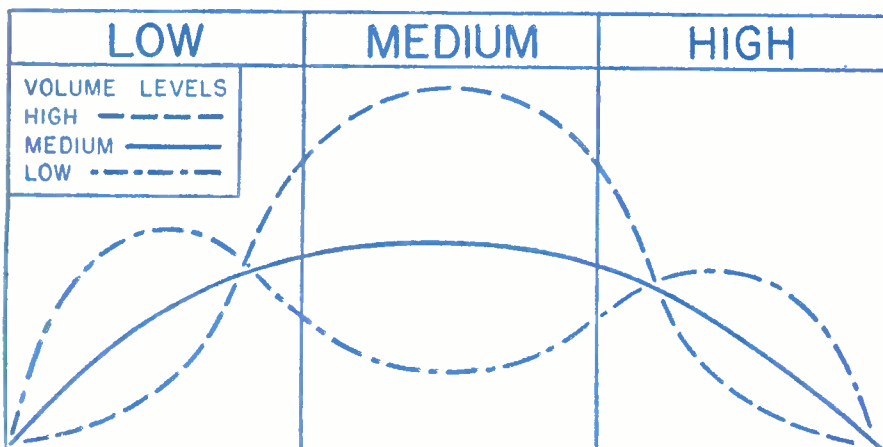

permits the full strength of low frequencies present in a recording to boost the audibility of bass tones. A value of 5 megohms should be satisfactory for this control, although some experimentation may be necessary to find a suitable value.

The series resistance and condenser by-pass controls form a filter system for varying the high-frequency response of the pickup. The highs, not appreciably affected by normal settings of the bass cutoff, are damped by the series resistance, around which they are by-passed through a condenser of 25 to 500 μfd . The ratio of resistance to capacity in this filter determines its effect on the high frequencies. The series load is usually set at 2 megohms for older types of 2½ oz. pickups, and at 5 megohms for the newer low-pressure units. With the by-pass inoperative, low notes are very prominent, but as capacity is cut in around the load, the highs increase, to where a 400- or 500- μfd . value transmits so much of them that the damping action of the resistance load is confined largely to the region of 4000-5000 cycles per second, where surface hiss and mechanical resonance peaks of the pickup predominate over recorded sounds.

Thus, by use of stepped or variable condenser by-pass, the filter network accentuates or cuts off the high-frequency bass cutoff control. Both controls operate effectively in the middle-frequency range, yet each retains its characteristic effect here as well as in its own particular zone.

Parts

As low-voltage audio circuits easily pick up a.c. noise from power wiring, the equalizer design includes complete shielding, a necessary practice extended in high-gain systems to include all cable and connections between pickup cartridge and amplifier chassis. Shielded wire is not available for non-war purposes, but excellent substitutes exist in single-conductor armored automotive cable from car-salvage lots, or can be made by winding single-conductor insulated wire with metal foil or with flexible sticky-tape radio aerial. Such improvised cable-shielding is quite satisfactory if there are no breaks along the shielding and care is taken to make good electrical contact at the ends of the shielding.

Elements of the high-frequency filter are more conveniently operated in steps through selector switches, but these may not be readily obtainable, hence Figs. 3 and 4 show alternate sets of parts, using either 6-stepped units or a 5-megohm volume control and a 450- μfd . t.r.f. condenser whose capacity increases with clockwise rotation.

A simple shield for the equalizer is a tin can with a removable lid, on which are mounted panel, input and output terminals and all controls, so that the body of the can is merely a removable cover. If the equalizer is to use stepped condensers, the flat

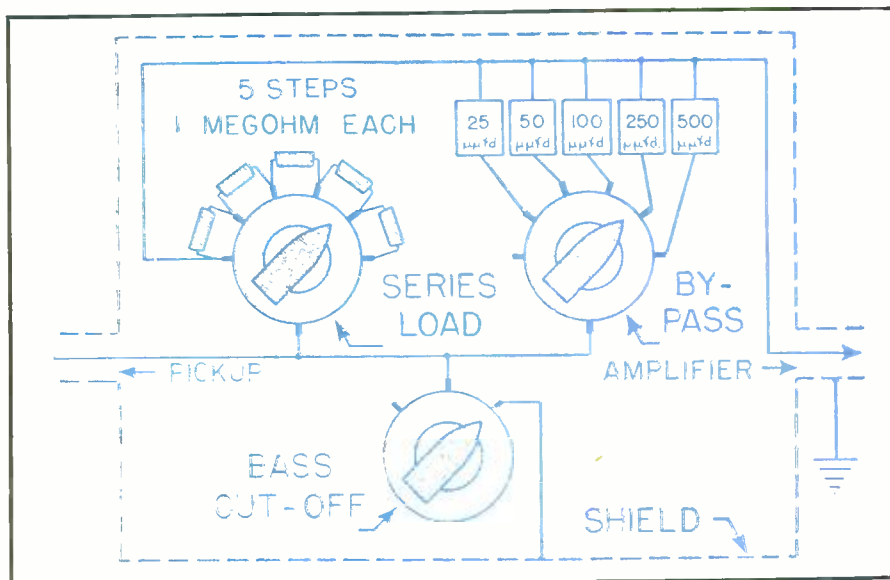

Fig. 3. Wiring diagram of the low- and high-frequency tone control. Six-position rotary switches are used to obtain a variation in the tonal response.

type of can in which 35-mm. motion picture film is shipped in bulk rolls is suitable. With a variable condenser, a larger can is necessary, but the insulated mounting may be bracketed to the can lid assembly also. In locating this mount on the panel and lid, clearance must be allowed for the condenser rotor to open fully without grounding to the shield cover, and the condenser frame must be kept from touching grounded volume control shells, for either contact would result in no signal to the amplifier. Detail of an insulated mounting for a variable condenser is shown in Fig. 2.

Assembly

If your plan includes phone-tip, phono or microphone types of connectors, mount these on the panel assembly, rather than on the shield can body, as the unit thus remains accessible for replacing aging volume controls or for checking connections

easily. In hooking up, mark fixed condensers with their values to avoid confusion, and solder all leads quickly to minimize overheating of resistance or capacitance elements via their terminal wires, particularly in assembling the stepped units, where working space between selector taps is cramped. Threaded shanks of volume controls or switches will hold the panel assembly together solidly if shakeproof washers are used beneath the shank nuts.

Numbered dial plates may be installed with the controls, but steps or reference points can be shown effectively by drilling shallow holes in the panel at points selected, and by filling each spot with a drop of red or white lacquer. In tightening bushing nuts, the maximum positions of controls (all the way right, clockwise) should fall at three o'clock, and the flat sides of volume-control shafts opposite, at nine
(Continued on page 142)

Fig. 4. Similar tone control to that of Fig. 3, using in this case continuously variable controls. A 5-megohm bass cutoff potentiometer is used.

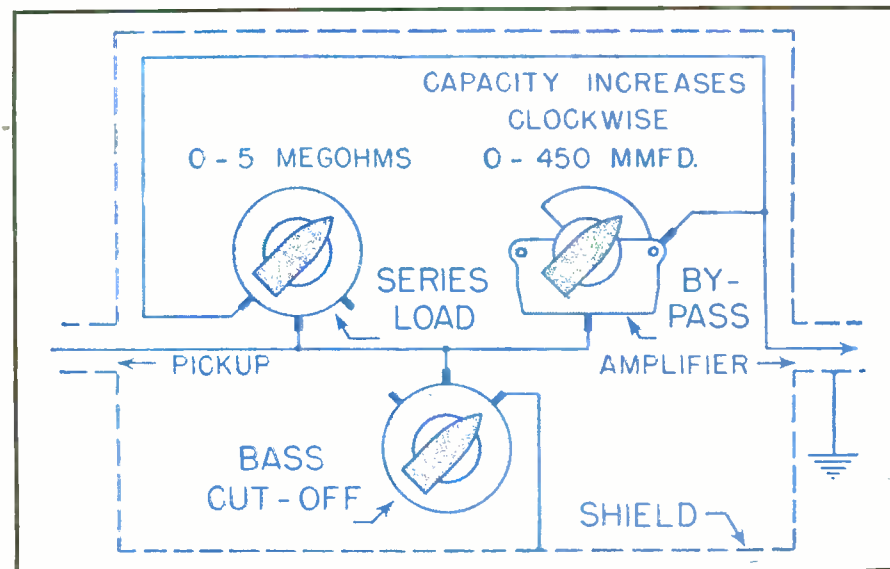

One of the trucks of the Capital Transit Co. that is being equipped with two-way FM radio. These trucks are used for general maintenance work on the electrical systems of the car lines. In addition, they also serve as emergency wagons. In the past, they have used standard AM one-way radio. With the two-way installations, calls for trucks and extra assistance by those already on the scene will be speeded.

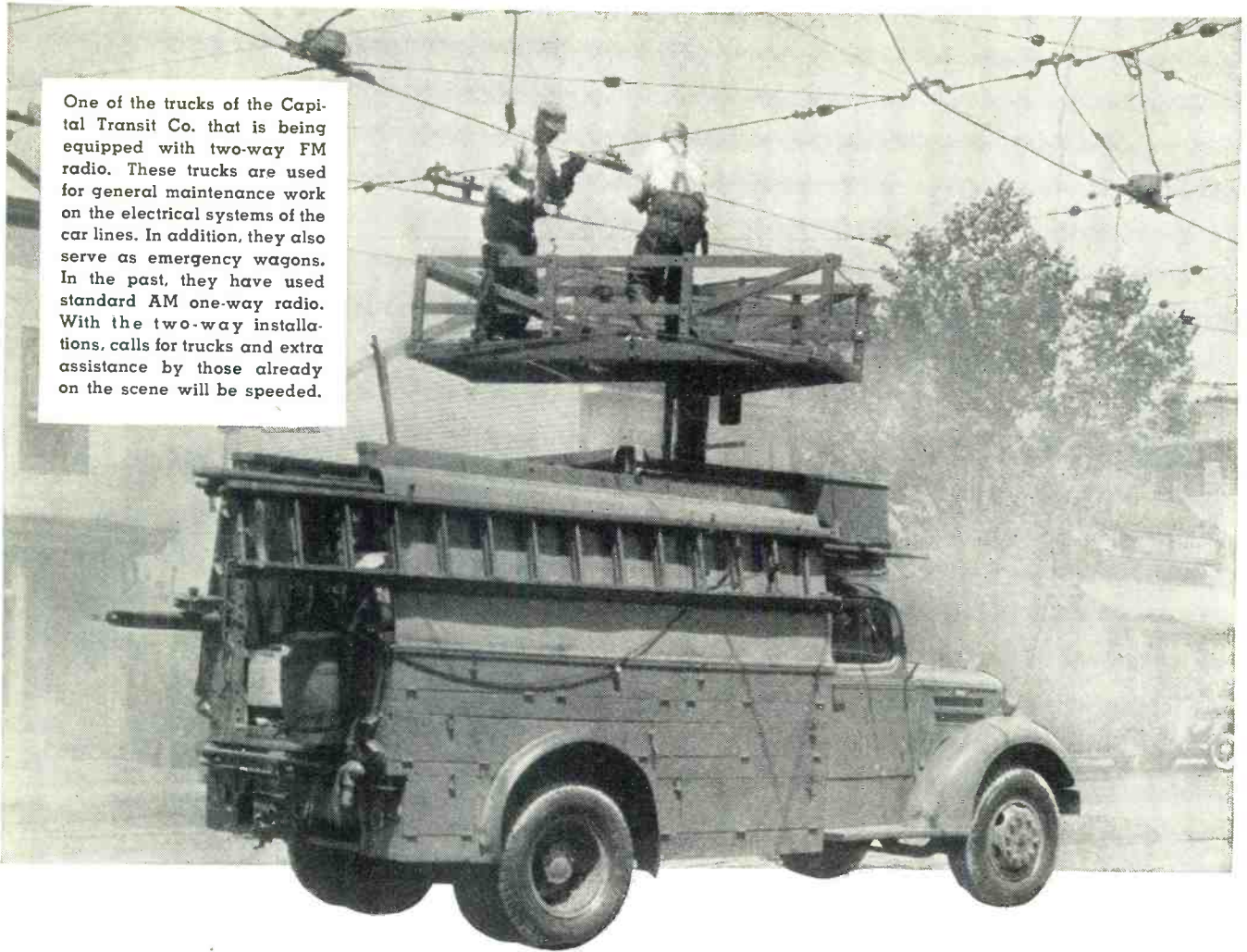

RADIO FOR TRANSIT

By JOAN DAVID

FM two-way radio is fast replacing the obsolescent AM one-way type as an aid in relieving many transportation difficulties.

FIVE thousand people were late to work in Washington last February 12th. A score of skeptical employers called the Capital Transit Company to check up and were reassured. There had been a two-hour delay on one of the busiest downtown-bound streetcar lines. Cabs were scarce and there were few private cars on the road. Sleet mixed with snow had fallen during the night and the ice-covered roads were innocent of sand. Such semi-Arctic municipalities as Boston and Chicago probably would have rendered their main thoroughfares navigable by the time the morning rush hour started. Icy streets in Washington, however, usually are regarded as a freak having no business so far south. Wait a day or two is the theory, and the problem will cease to exist.

And so, despite and because of the 15-degree weather, the crowds at the streetcar stops were bigger than usual. The trouble started at about 8:28 a.m.

Here, in essence, is Capital Transit's record of the event: A telephone call received in our central dispatcher's

office at 8:33 a.m. informed the dispatcher that two cars were standing at 18th and Columbia Road, N.W., without current. By telephone at 8:34 a.m. emergency truck No. 105 was dispatched to the scene of the trouble. At 8:35 a.m., by one-way radio (shared by the local power company which broadcast messages phoned to it by Capital Transit's dispatchers), No. 65 cruiser, a Transportation Department Supervisor, was also dispatched to the scene. By 9:01 a.m. no report had been received in the central dispatcher's office regarding the trouble. At this time, 9:01 a.m., No. 67 cruiser, Transportation Supervisor manned, was dispatched by one-way radio, and at 9:09 a.m., No. 72 emergency truck

was dispatched by telephone. At 9:15 the wagonman in charge of No. 105 truck reported in with details on the cause of the breakdown. Eighteen cars had run through a broken rail and been so damaged that they could not collect current. Thirty-eight more cars which had started down the same route were stalled on the line until it was cleared. Eighteen cars in a row unable to proceed under their own power provided an extremely difficult problem. It was necessary to obtain heavy trucks to push these cars to a location where repairs could be made. Throughout the 115 minutes detention the line was at a standstill. There was no means of turning the cars back.

If the whole incident were transposed ten months to December 12, 1944, this unavoidable accident might have caused a total delay of only 30 minutes. For, toward the end of November, the Capital Transit Company began the operation of its newly licensed frequency-modulation 250-watt transmitter which, together with the two-way General Electric 30-watt mobile units installed on each of their 30 emergency trucks and supervisory cars, has more than halved the time needed to handle emergencies.

Capital Transit's chief engineer, Ronald Thring, explains that the incident, if duplicated today, might develop in an entirely different manner. "Eighteen cars would not have been placed out of service because No. 105 emergency truck and No. 65 cruiser would have coordinated their activities and held the line at the point of fault. No. 105 emergency truck would, in all probability, have cleared the trouble in about ten minutes. There would have been no more than eight cars crippled. At least sixty cars would have been rerouted if talk-back had been available. Thirty-eight cars which ran in after the fault developed and were tied up throughout the 115 minute delay could have been freed for other service. Other emergency wagons could have been dispatched on arrival of No. 105 truck, instead of 29 minutes later. Inspectors could have been sent to cut-backs or points at which the line could have been rerouted. Regular routing could have been re-established immediately after the line was cleared instead of after

UTILITIES

fifteen minutes of telephoning.

The Capital Transit Company, with its new station WQHA, is the 13th transit company to install its own radio facilities since 1938, when the Federal Communications Commission first decided that transit utilities might be assigned frequencies in the 30-40 megacycle band, which is reserved for emergency use. (Police, forestry, marine, and other government services share this same band.) That decision was an amendment to a general reallocation of frequencies made possible by the widening of the usable spectrum due to developments in short-wave.

Today the FCC is again making a general reallocation of frequencies. Investigations have shown the need for such reallocation, although permanent decisions in most cases are contingent on international agreement and will be put off until the postwar period insofar as possible. The important advances in radio and the tremendously increased demands on
(Continued on page 144)

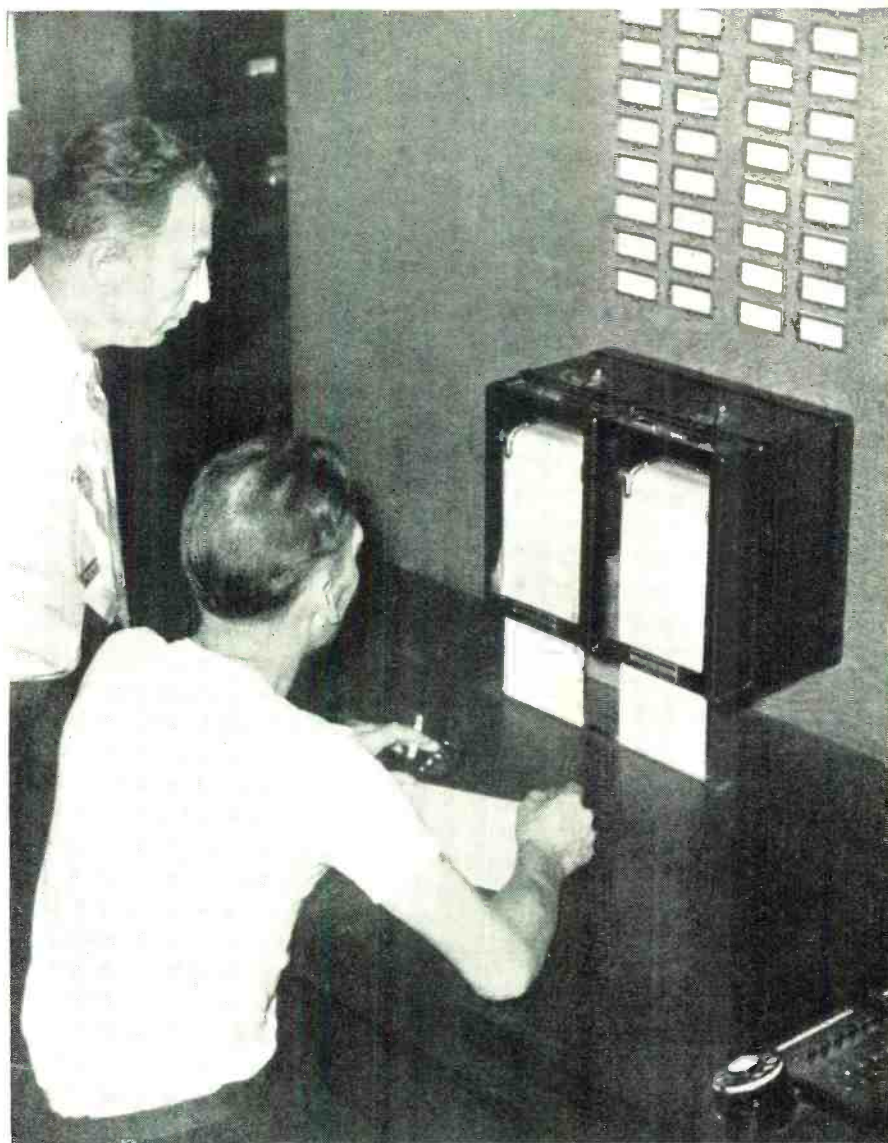

"Headway recorder" automatically records the passing of streetcars at 40 points scattered over the company's system. Transit failures are indicated by this machine.



"Dispatchers' desk" in the Central Dispatchers' Office of Capital Transit Company, Washington, D. C. Through two-way radio, any assistance that the calls indicate are needed can be sent more quickly than possible ever before.

THE TELEVISION CHANNEL

By EDWARD M. NOLL

Part 2. Continuing our study of television, the author discusses the standard television broadcast channel.

THE standard television broadcast channel is six-megacycles wide, as seen in Fig. 1, and contains both the picture and sound carriers plus sidebands, the picture signal occupying the greater portion of the channel. The picture is amplitude modulated and occupies a $5\frac{3}{4}$ -megacycle channel; the sound, frequency modulated with a 150-kilocycle channel. An exceptionally broad picture band is necessary to transmit a sharp well-defined picture; in fact, the wider the channel the better the sharpness and definition becomes. Consequently, while a 10,000-cycle band is adequate to transmit an amplitude-modulated sound signal, a band of at least 4,000,000 cycles is required to transmit a satisfactory picture. With that end in view a portion of the low-frequency picture sideband is attenuated at the transmitter and not radiated from the antenna. Observation of the drawing shows that the low-frequency sideband is only $\frac{3}{4}$ -megacycles broad, while the flat portion of the high-frequency sideband is 4-megacycles broad. Thus, it is possible to obtain a 4-megacycle defini-

tion in a 6-megacycle channel with partial suppression of one sideband—called vestigial-sideband transmission. The most to be expected in a 6-megacycle channel with symmetrical picture sidebands would be a flat sideband of $2\frac{1}{2}$ megacycles.

Two $\frac{1}{2}$ -megacycle guard bands are located at the edges of the picture sideband to allow the signal to fall from maximum amplitude to a very low level, without overextending the low-frequency end of the channel or interfering with the sound signal. The sound carrier is $4\frac{1}{2}$ megacycles above the picture carrier, and is permitted a maximum deviation of ± 75 kilocycles with modulation. In a recent proposal by the television panel of the Radio Technical Planning Board it has been suggested that the deviation be reduced to ± 25 kilocycles. As an aid in obtaining a clear conception of a typical television channel, the layout of the first three channels is given in chart form in Table I.

Scanning

In modern television systems scan-

ning is an electronic process; first, the electron beam at the pickup tube, under control of an electron gun, moves across the photosensitive mosaic left-to-right and top-to-bottom progressively gathering the light distribution off the mosaic. And, second, by a similar process the electron beam in the picture tube, also under control of an electron gun, moves across a fluorescent screen and reproduces the original variations in light and dark. To reproduce the picture accurately it is necessary that the electron guns of both tubes direct their beams at the same relative position on both screens for any given instant. Therefore, the transmitted signal not only contains picture information (actual variations in light and dark) but also the necessary signal (synchronization pulses and blanking) which keep the electron beams in step.

The scanning process is performed by sawtooth voltages similar to those used in an ordinary cathode-ray oscillograph. As demonstrated in Fig. 3A, the slow linear rise of the horizontal sawtooth voltage moves the electron beam from left to right (a to b) across the screen in approximately 53 microseconds. When the beam reaches the right side the faster change in voltage of the sawtooth, rapidly returns the beam from right-to-left (b to a) in approximately 10 microseconds. This motion is repeated 15,750 times per second and produces line ab on the face of the scope, just as it would if applied to the horizontal deflection plates of an ordinary oscillograph. However, in the television cathode-ray tube we not only apply a horizontal sawtooth but also a much slower vertical sawtooth. Now with the vertical sawtooth of 60 cycles-per-second applied to the vertical plates as shown in Fig. 3B and with no sawtooth applied to the horizontal plates, the linear rise of voltage would move the beam from top-to-bottom (c to d) in approximately 15,400 microseconds. When the beam reaches the bottom the faster change in voltage of the sawtooth returns or retraces the beam in approximately 1250 microseconds (d to c). If we apply the sawtooth voltages to both sets of plates, Fig. 3C, the beam is moved rapidly across the screen (horizontal sweep) but at the same time the beam is moved slowly down the screen as

(Continued on page 110)

The National Safety Council's miniature "Safe Home" was the subject of what is believed to be the first safety telecast in history. This telecast took place over Television Station WBKB, the Balaban & Katz station located in Chicago.

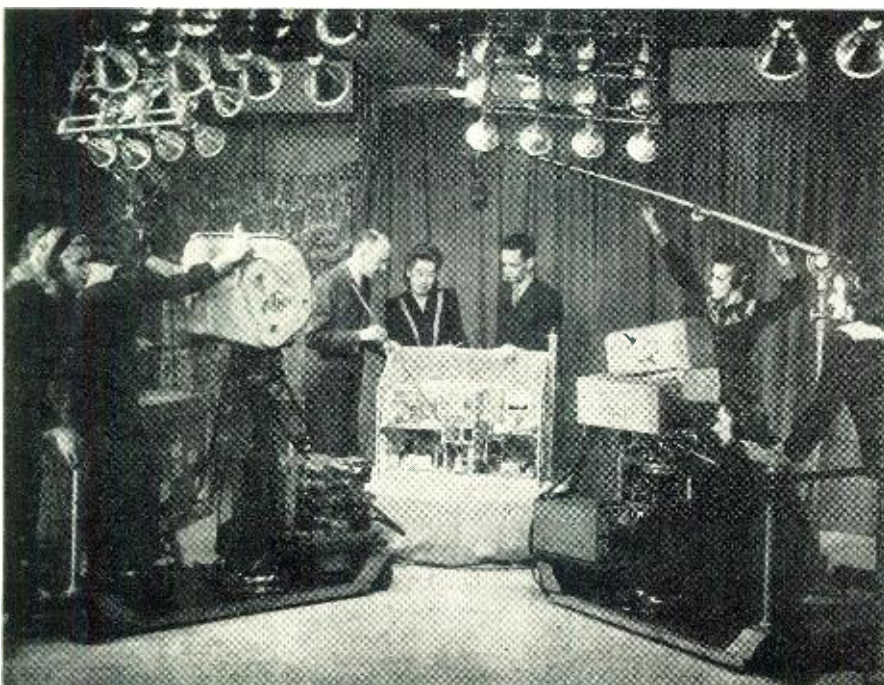

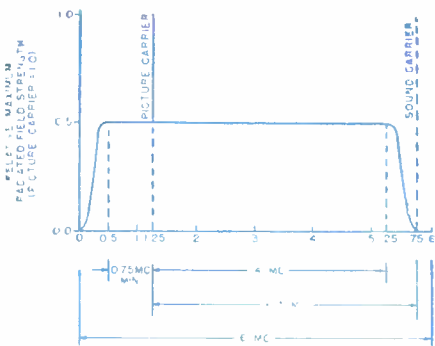

Fig. 1. Idealized picture transmission amplitude characteristics. This is based upon a television channel 6-mc. wide.

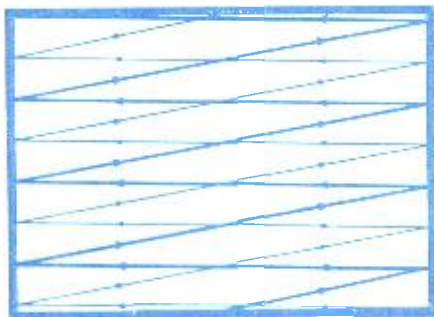

Fig. 2. Beam returning from bottom to top.

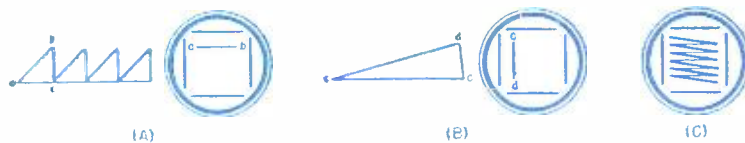

Fig. 3. The scanning process, (A) being the horizontal sweep, (B) the vertical sweep, and (C) the combination of both the horizontal and vertical.

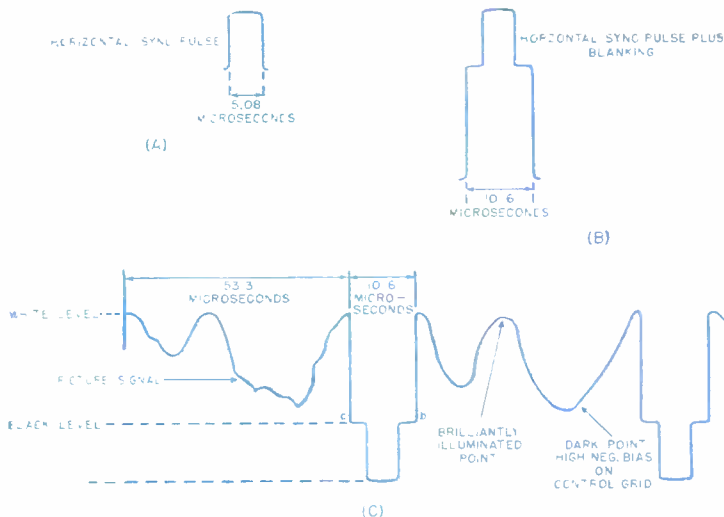
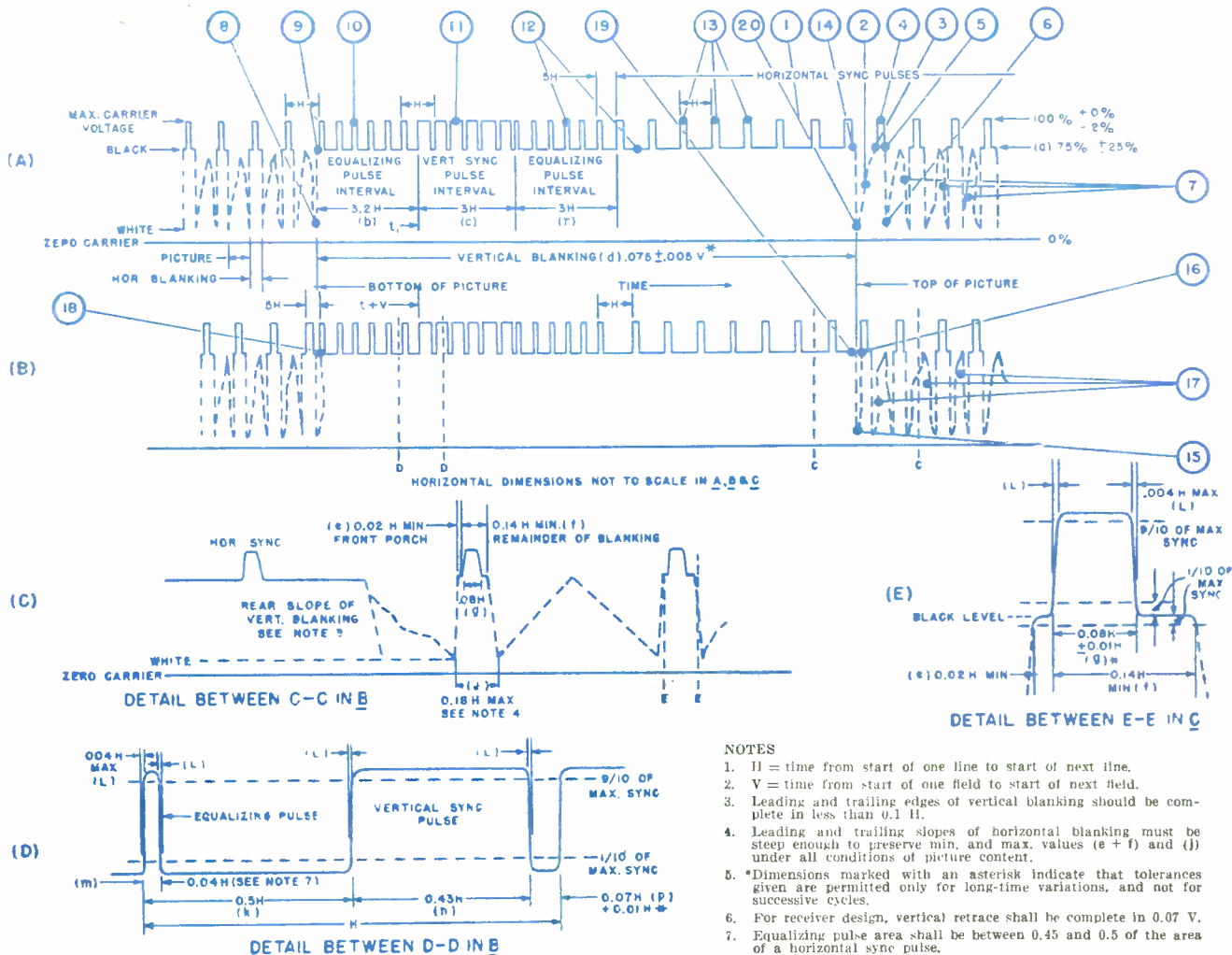

Fig. 4. Television signal as it appears on control grid of picture tube.

Fig. 5. Television synchronizing waveform for amplitude modulation.



NOTES

1. H = time from start of one line to start of next line.
2. V = time from start of one field to start of next field.
3. Leading and trailing edges of vertical blanking should be complete in less than 0.1 H.
4. Leading and trailing slopes of horizontal blanking must be steep enough to preserve min. and max. values (e + f) and (j) under all conditions of picture content.
5. *Dimensions marked with an asterisk indicate that tolerances given are permitted only for long-time variations, and not for successive cycles.
6. For receiver design, vertical retrace shall be complete in 0.07 V.
7. Equalizing pulse area shall be between 0.45 and 0.5 of the area of a horizontal sync pulse.

Multi-Band 30 WATT TRANSMITTER



Fig. 1. The transmitter constructed in two separate units: transmitter proper and power supply.

By **McMURDO SILVER**
Plainville, Conn.

A masterpiece in miniature with dual-crystal control, and built-in antenna-matching network.

LOOKING forward to the period slightly after V-Day when the amateur radio operator will be permitted to resume practice of his hobby, which has stood his Uncle Sam in such good stead in two successive wars, is responsible for the equipment here described. It is entirely possible that, in the normal bustle of peacetime amateur activity, that the order of contemplation leading up to its creation might never have been indulged.

During enforced quiet evenings thought seemed to turn continually to amateur equipment. Consciousness gradually developed that there was no design, clean-cut and workmanlike, to which the amateur, beginner or experienced "oldtimer," seeking serious portable gear, could turn with the assurance that if he followed straight through on a clearly defined path he would come out with a shipshape rig. True, innumerable amateurs have designed and built such equipment for themselves, but each was an individual job involving a considerable amount of tinkering and puttering about to finally get it to work acceptably. It occurred to the writer, as he contemplated this prob-

lem, that such leisure hours as he had after devoting most of his time to the war effort might be put to good use trying to translate the excellence and dependability, coupled with the desired easy serviceability, of military radio equipment into a solution of this problem.

The result is pictured in Figs. 1, 2 and 3, and diagrammed in Fig. 4. Unfortunately the photograph of Fig. 1 ran so dark as to lose the label-detail of the cigarette package visible between the transmitter proper and its 115/125 volt, 50/60 cycle a.c. power supply.

Nevertheless the white object with the dark center "bulls-eye" is a standard, regular-size package of cigarettes which was placed in the photo just before it was shot to dramatize the compactness of both units. Soon to be produced as factory-built and tested equipment by the Grenby Manufacturing Co., of Plainville, Conn., they also will be available as kits for those desiring to "roll their own," while the always-difficult-to-produce-at-home metal panel, chassis and cabinet similarly will be commercially available to the trade.

This course is pursued with the

thought of giving maximum possible assistance to amateurs desiring to build such units but already having many of the standard commercial parts on hand. To those interested, it is more than probable that their junk-boxes will yield up the small number of needed parts even today, so that they may get their hands back in, and get ready for the opening gun of resumed amateur operation by building replicas at once. Such replicas may be tested upon dummy antennas for which a 115-volt, 15-watt lamp is a good substitute. Despite its nonantenna-like impedance, such a bulb will function very nicely as a dummy antenna for this transmitter, since the built-in antenna-matching network will feed almost any kind of antenna at all—from a couple of feet of wire up to a telephone line!

The 8" long by 5" high by 3½" deep box of 1/16" aluminum, painted with Navy grey enamel at the left of Fig. 1 houses the entire M.O.P.A. transmitter with its rear view in Fig. 2 and its "engine-room," or bottom view, in Fig. 3, left. The circuit, Fig. 4, shows that the basic design uses a 6V6GT beam tube as an oscil-

lator-frequency multiplier, followed by an HY65 30-watt-input beam power amplifier in the final stage. Visible just in front of the 6V6GT oscillator tube in Fig. 2 is the dual crystal socket, a wartime development designed to accept simultaneously two of the small, rectangular Signal Corps type FT243 crystal holders such as will no doubt be standard amateur items after the war.

The installation of two crystals permits operation upon either crystal's fundamental frequency, as well as upon appropriate multiples thereof by multiplying frequency in the Tri-tet oscillator circuit, in the final amplifier, or both. Either crystal is selected from the panel by a conventional type of three-position slide switch which was redesigned especially for this and similar applications by eliminating low-grade insulation and substituting low-loss phenolic, together with large-area silver-plated contacts. Crystals are labeled X1 and X2 in Fig. 4, with their selector switch S1.

Harmonic oscillator operation is insured by inclusion of the tapped cathode coil, L1, in the oscillator cathode circuit. Switch S2, identical to S1, allows selection of the entire coil for 3.5-mc. crystals, a smaller portion thereof for 7-mc. crystals, or the short-circuiting of the entire coil for straight-through operation with any crystal frequency between 1750 and 30,000 kc. L1 is visible just to the upper right of the oscillator tube socket seen at the lower left of Fig. 3.

The oscillator plate circuit is conventional in that it uses a 100- μ fd. "APC" type of ceramic-insulated variable air capacitor to tune coil L2, which is wound upon a commercial Polystyrene form $\frac{3}{4}$ " long having five pins, of which only two are used for winding terminations. Winding data for all coils is shown in the parts list of Fig. 4. The 3.5-mc. coil also will cover 7 mc., while the 14-mc. coil covers right on through to 30 mc. when the oscillator is putting out at a high crystal harmonic—and it is possible to get useful output at 28 mc. from a 3.5-mc. crystal in this little rig.

Mazda #49 dial lamp, B1, indicates crystal r.f. current at the same time it acts as a fuse to prevent crystal fracture in event of overloading or improper adjustment in tuneup. This 60-ma. lamp, together with its counterpart, B2, in the final plate circuit, both are located upon the front panel next to the two switches which control crystal and oscillator cathode circuits. They make unnecessary the use of meters in initial tuneup or operation, since indicating the two vital currents in the circuit, tuneup for maximum power output on crystal fundamental or harmonic frequencies is made easy—two 10-cent lamps replace two seven-dollar meters, protect the crystal, and save large "chunks" of space.

The AMP. knob to the right of the OSC. knob in Fig. 1 controls the 100-

μ fd. "APC" tuning capacitor for the final amplifier plate circuit, seen to the left of Fig. 2 just behind the horizontally-mounted HY65 power amplifier, and to the right of its plate coil, L5. In Fig. 2 it can be seen that the HY65 socket (tube plate in a vertical plane) is mounted to the right of a vertical partition joining panel and chassis into a rugged structure; the tube itself is projecting to the left through a $1\frac{3}{8}$ " hole. This partition provides essential shielding between oscillator and amplifier circuits, so that the whole transmitter runs "cool" without any trace of undesired oscillation or instability, and without need for always-tricky neutralization. The grid lead to the amplifier is carried "upstairs" through the ceramic stand-off insulator seen near the HY65 socket in Fig. 2, while its plate lead is carried "downstairs" to r.f. choke L4 by a second such insulator near the HY65 plate cap. C6, C7a, R7 and R8 are all mounted closely about the HY65 socket for short, direct leads, the common connection of R7, R8 going to a dead lug on the HY65 socket.

The antenna-matching network is a simplified pi-circuit, involving the addition to the basic circuit of C9a, C9b, C9c, and S3. S1, S2, and S3, each has an open center position, with two separate closed positions, one at each end. Each is thus a single-pole, two-position switch plus a neutral, or open, position. C9a is the fine antenna-matching adjustment, and could do the entire job, in fact, were it available in sufficient capacity. Its procurable 140- μ fd. maximum is not sufficient to take care of all possible antennas to be anticipated in portable operation, so

it is padded up through S3 which adds C9b or C9c in parallel with C9a when required. This type of antenna-coupling circuit is used widely in serious commercial equipment, and its virtues are so great that it is to be strongly recommended to amateurs. It is ideal in choice both as to antennas and frequencies—a great boon indeed to easy tuning and efficient power transfer.

The transmitter construction is so clearly illustrated in Figs. 1, 2 and 3 as to deserve little further comment here—except to say the panel, chassis, and cabinet drawings may be had on application to the writer at no charge other than for postage and blueprinting. Operation is so clean and straightforward as to be a delight. Keying is done in both cathode circuits to minimize drain on the power supply in portable operation, when it presumably would be a vibrator-type unit driven from a 6-volt car storage battery. Chirping is noticeable by its absence, even though in keying, the plate voltage of the a.c. power unit illustrated varies from about 325 volts at full 85-ma. load up to 490 volts at no load!

Tuneup initially involves removal of the HY65, plugging of a key into the KEY jack on the front panel, insertion of appropriate oscillator crystal and coil, and tuning of OSC. dial for minimum crystal current as indicated by XTAL bulb, and as found just on the low-C side of oscillation stoppage. The HY65 is then inserted and its plate circuit tuned for minimum-current resonance-dip. Oscillator and amplifier tuning is trimmed up a bit, and the ANT. capacitor is adjusted for greater AMP. plate current lamp brilliancy at resonant dip—when all

Fig. 2. Rear view of the transmitter proper. The HY65 tube should be mounted horizontally so that all leads to the tube are as short as possible.

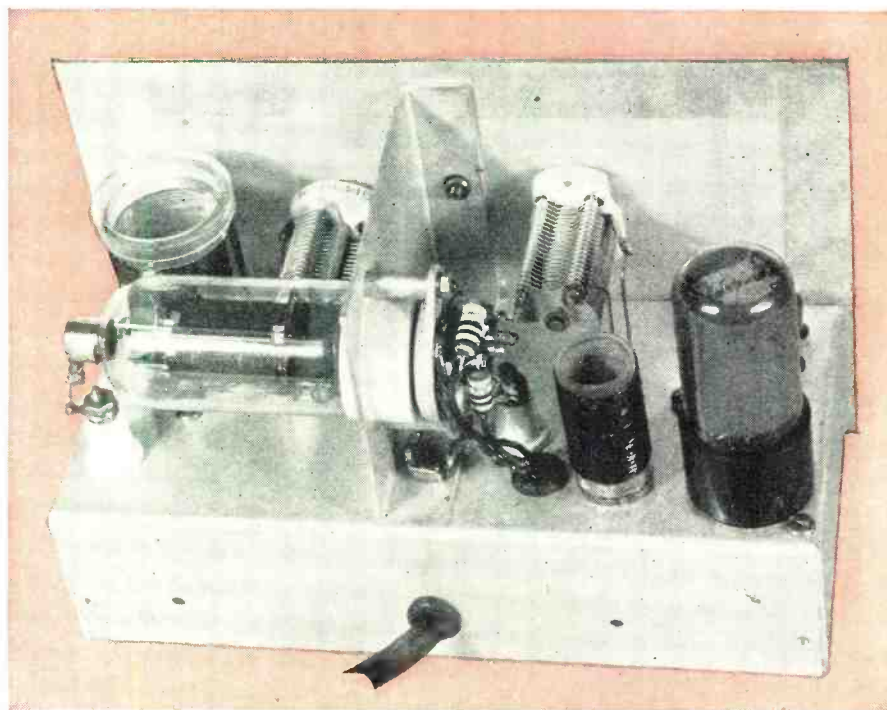

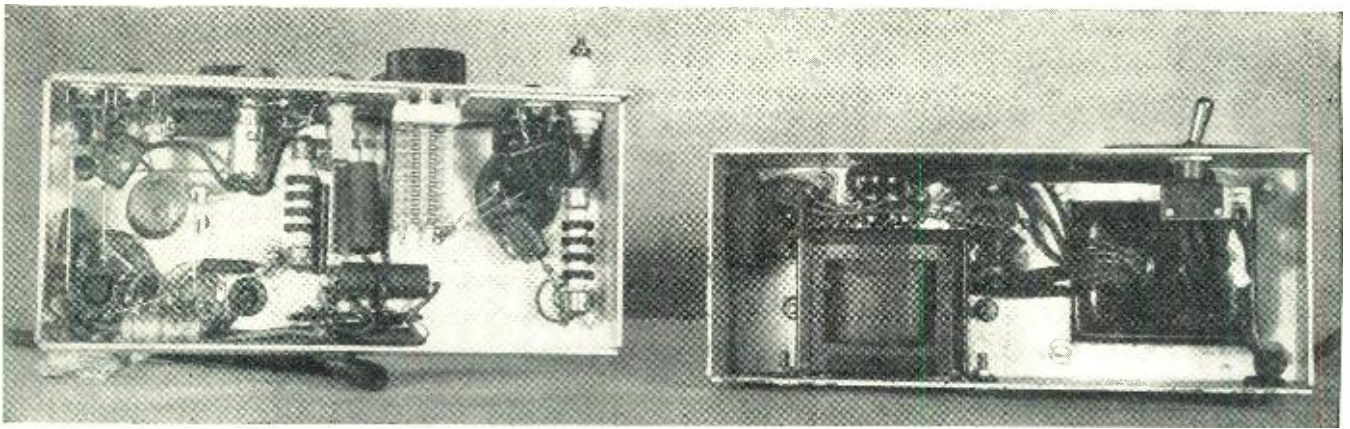

Fig. 3. Under-view of both chassis. All components should be spaced properly and wired so that no interaction will occur.

is done. This latter condition corresponds to maximum brilliancy of the 15-watt lamp used as dummy antenna initially.

The power supply, also of 8" by 5" by 3½" size, is mounted on a conventional chassis, no cabinet being necessary to protect its relatively rugged component parts, nor desirable in terms of heat confinement in a neces-

sarily small cabinet. This power unit is built as diagrammed—with a double-section filter involving three electrolytic filter capacitors contained in a single, instantly replaceable plug-in unit like a vacuum tube, and two filter reactors. This is because the power supply also is intended to power a companion receiver when not used for transmitting, and the receiver benefits

by more filtration than is needed by the transmitter. Thus, for transmitter operation alone, the reactor seen above the chassis might be omitted, as might C12, since both are used only in receiver operation. The circuit diagram appears at the bottom of Fig. 4, as does a listing of essential electrical component parts.

This compact little assembly, each unit of which is almost small enough to slip into an overcoat pocket, is a serious DX-worker, indeed, if power inputs and outputs and antenna characteristics be considered. Power input to the final stage with the supply illustrated will be about 16.25 watts—325 volts at 50 ma.—, with the output at around 60% efficiency, or about 10 to 11 watts. This is on crystal fundamental. On second harmonic operation output falls off a bit to about 8 watts, and drops further to about 6 watts on 3rd and 4th harmonics of crystal frequency. Outputs will go up proportionately if effective plate voltage is raised to 450 volts, the top rating of the HY65, when 20-watts output or a bit better may be expected on crystal fundamental frequency. Such powers are not to be overlooked by the beginner, or by the "oldtimer" either, for the latter knows that they are capable of plenty of DX under halfway decent conditions. And its neither good sense nor good sportsmanship to use a "rock-crusher" to put out a signal louder than needed for essential communication at the price of excessive nearby interference. Nor should it be forgotten that doubling power will only give a 3-db. increase in audible receiver volume at a distant point—so little as to be barely audible!

The same type of basic design and structure here illustrated need not be confined to a small unit such as the r.a. p.a. combination. Its inherent cleanliness can be retained, and power capability "blown up" by simply increasing size as necessary to accommodate a 6L6 oscillator driving an 814, or even an 813 at 360 watts plate input, approximately 260 watts antenna output! While it is true that using but low-frequency crystals, some loss of output will result when tak-

(Continued on page 141)

Fig. 4. Wiring diagram of the transmitter shows simplicity of design.

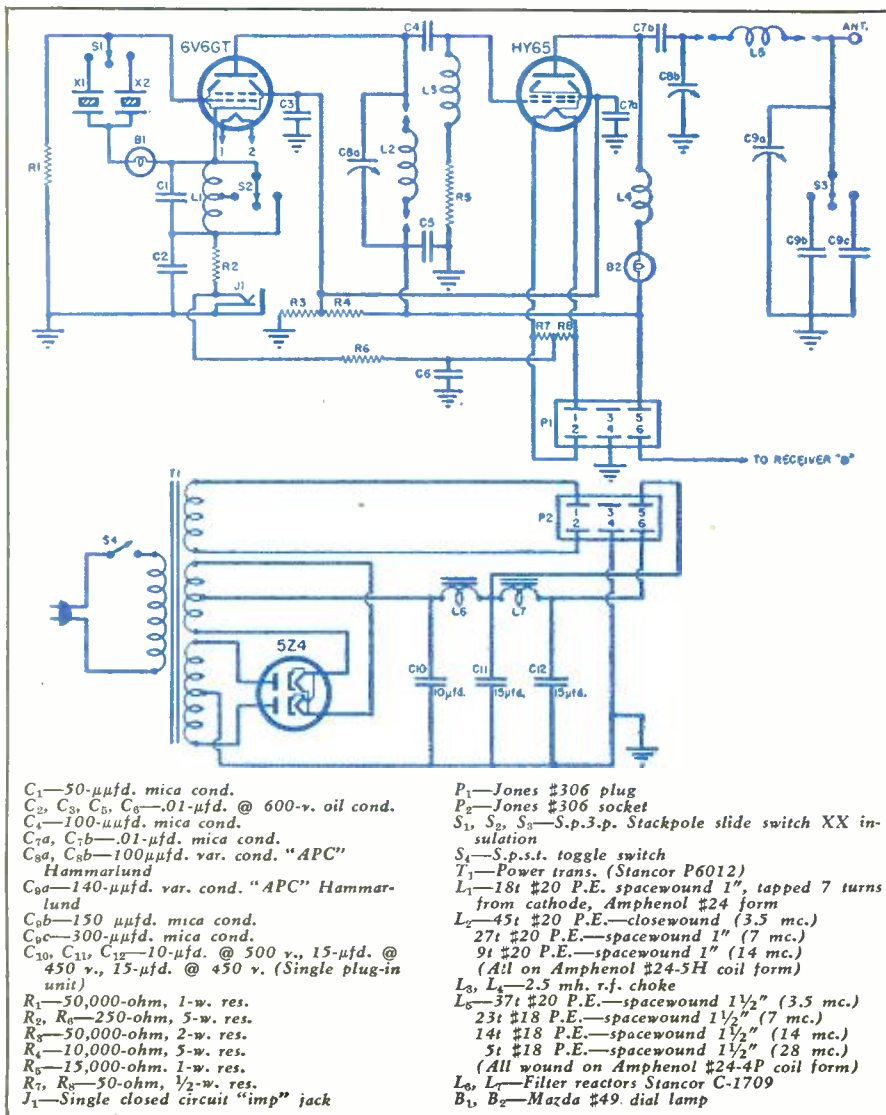

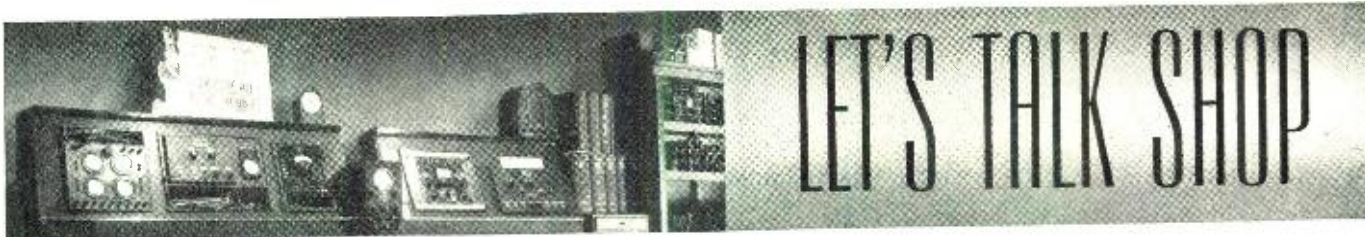

IN PREPARING for postwar operation of radio and electronic service establishments, there are a number of factors which should be taken into consideration by men who are now in the business, as well as those who intend to enter it. As you all know, competition will be very keen. The present large volume of radio repairs will be subject to a sharp drop immediately after new civilian sets are available. There will be a great influx of returning servicemen who will desire to get into the retail sales and service field of the radio and electronic industry.

The existing service shop will be "hard-put" to hold its present position in the face of this type of competition, especially since it must be remembered that a returning Serviceman will be trained at government expense. Most important, this training probably will be along the lines of advanced servicing in the ultra-high-frequency fields, in which we expect most of the progress after the war. In addition, the government will lend these men a sum not exceeding \$5,000 for the establishment of their own businesses. Therefore, you should very carefully examine your own position in your community and find exactly how you can best meet this competition and retain for yourself a fair share of the business which is available.

One of the ways that this can be accomplished is to go into the wholesale service business. By this, I mean the individual serviceman that does servicing and installation for retail sales dealers who do not have service establishments of their own. This manner of servicing is quite a bit different from the ordinary and I shall discuss at length some of the problems encountered in this type of work.

There are several things generally necessary for the successful operation of this type of business. First, you must have unquestioned personal integrity, and must have the respect of the dealers with whom you do business. Since you and the dealer both are operating in the same territory, if any attempt is made to deviate from honest business policies, the dealer, of course, will not give you his work. You must realize that the dealer takes a tremendous risk in sending an independent serviceman into the homes of his customers, unless the serviceman is thoroughly honest and will not chisel in any way. Second, no sale of radios can be permitted since this is in direct competition with the dealer. In other words, if you are in the wholesale radio service business, it generally is expected

With **JOE MARTY**

Field Editor, **RADIO NEWS**

that you will not sell radio sets, excepting for the dealers for whom you work. Third, your establishment will need more men in order that the calls and the service work can be done in an orderly and efficient manner and with as little loss of time as possible. Fourth, it is obvious that if you have more men, you must have more equipment for these men to work with. You should not under any circum-

EDITOR'S NOTE: Mr. Marty will address the Philadelphia Servicemens Association on Tuesday, February 20th. His subject will be "The Future of the Radio Serviceman."

stances stint yourself as to equipment since it is only by taking advantage of short-cut efficient servicing methods that you will be able to turn out the necessary volume to show a profit. The fifth thing that is needed is more space. If you have been operating up to this time as an individual, or a shop with one man and limited space, you must consider going into larger quarters for the new operation. Of course, a larger stock of parts is imperative where the volume is larger than you have been accustomed to in a one-man operation.

Types of Operation

There are two types of wholesale operation, the first of which the radio serviceman picks up the sets from his dealers and takes them to his own shop for repair. This is, of course, the least involved method of operation because there is very little selling

attached to it. The jobs under this type of operation may, therefore, be handled on a fixed charge basis, charging so much per job per set, or they may be handled on a time and material basis for which the charge is made. Usually a discount is extended to the dealer in any case. This discount should be varied, depending upon the volume which any one dealer gives to the serviceman. If you have a dealer that has a relatively few sets to be repaired, I would suggest that he be placed on a lower discount rate than the dealer who gives you a large number of repair jobs. In this type of operation the serviceman furnishes tubes and the necessary parts for the repair of a receiver.

The second type of operation is one where the serviceman actually assumes complete charge of the dealer's service department. Under this plan, the serviceman makes the calls as they are received by the dealer. He estimates the amount of repair, does the repair work and returns the set to the customer's home. Immediately you will realize that this is a more complicated type of procedure yet it offers much to the dealer in the way of service, which he cannot furnish if he does not have a service department of his own. Under this method, the estimated charge to the customer is the final retail selling price. From that price, the dealer is entitled to a discount, as mentioned above, depending upon the volume of work done. This discount should be figured very accurately and fairly, in order that

the dealer may make money on his service department and also provide adequate compensation for you.

Arrangements should be made with the dealer to compensate the serviceman for the sales of all radios and appliances sold on the job. Some commission, probably less than the regular salesman's commission, generally is extended.

In some cases dealers will want to furnish their own parts for the repairing of

(Cont'd on page 140)

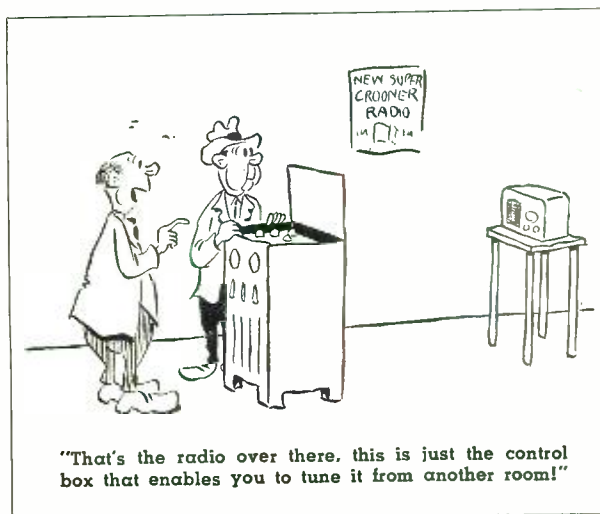

PRACTICAL RADIO COURSE

By ALFRED A. GHIRARDI

Part 31. Further study of spurious interfering responses that can occur in AM superheterodyne receivers. Methods of attenuating their effects are discussed.

THE remaining forms of spurious interfering responses that can occur in AM superheterodyne receivers will now be analyzed.

Local-Oscillator Radiation Interference

The function of the local oscillator in a superheterodyne receiver is to generate a stable, unmodulated high-frequency signal that is fed to the mixer or frequency-converter where it acts upon the "desired" incoming modulated signal to produce a similarly-modulated signal of specially-chosen new frequency known as the intermediate frequency (i.f.). Unfortunately, however, unless special precautions are taken in the design of the receiver all of the r.f. energy (signal) generated in the local oscillator will not be confined solely to its proper use in the mixer or frequency-converter stage. Since the oscillator is virtually a low-powered radio transmitter, interfering energy (signals) from it may find its way into neighboring receivers by any one or more of the following five different paths:

- (1) Feedback through the mixer and r.f. amplifier circuits and wiring to the antenna circuit of the receiver, and subsequent radiation of the energy from this antenna circuit over a limited area to other receiving antennas in the vicinity.
- (2) Coupling between the filament and plate supply leads of the oscillator.
- (3) Direct coupling between the oscillator and antenna circuit.
- (4) Leakage back to the power supply line (in line-operated receivers only) which may either conduct it to other receivers through power line, or else radiate it to nearby antennas.

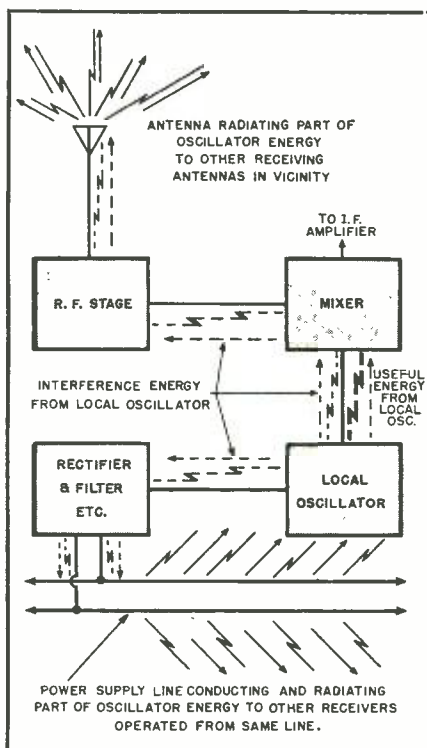
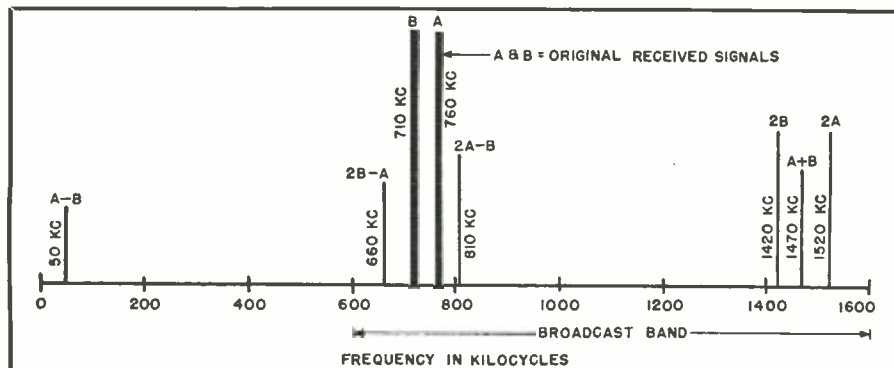

Fig. 1. How part of the r.f. energy of the local oscillator may find its way to the receiving antenna and power-supply line and be radiated from them to other nearby receivers, causing interference.

- (5) Radiation over a limited area from the metal case of the receiver.

Fig. 1 illustrates the paths by which the oscillator energy can feed back in the first four cases. The first of these usually is found to be the worst offender in causing interference, and is the most difficult to control.

Fig. 2. Cross-modulation signal frequency products obtained by rectification of the two original received signals of frequencies A (760 kc.) and B (710 kc.). The new harmonic frequencies, 2A and 2B, and the new combination frequencies, 2B-A, 2A-B, and A+B, may cause interference since they all lie within the standard broadcast band.



The interference caused in other receivers which may pick up this energy is evidenced by a "whistle" on a particular desired station, appearing, then disappearing, and changing in frequency more or less at random. This interference becomes prevalent and of special importance in congested metropolitan areas where many receivers are located close together in apartment houses, are fed from closely spaced antennas and derive their operating power from a common electric light circuit. Trouble may come about in the following way if the owners of such receivers are in the habit of listening to two stations that differ in frequency by the amount of customarily employed intermediate frequencies.

For example, in a community having a popular station transmitting at 700 kc. and another at 1150 kc., receivers using a 450 kc. i.f. when tuned to the 700-kc. station will have their local oscillators set at $700 + 450 = 1150$ kc. If these 1150-kc. local oscillators radiate energy from these receivers in any one or more of the five ways previously enumerated, it will cause a "whistle" in those nearby receivers which are tuned to the 1150 kc. broadcasting station. The whistle will change pitch as the tuning of the radiating receiver, or that of the other receivers, is manipulated about the exact tuning point. Also, when the tuning of a superhet is varied from one end of a band to the other (as is customary when "searching" for station programs) the local-oscillator frequency is being varied throughout its entire range. If the oscillator radiates appreciable energy, doing this may be the equivalent of sending out signals on 20 or 30 different wavelengths from the receiving antenna. These will be picked up by nearby receiving antennas—causing momentary interfering "whistles" to appear in the receivers.

In modern radio receivers the intensity of the radiated oscillator energy is reduced by using one or two stages of tuned r.f. amplification ahead of the oscillator and mixer, by more careful design of the oscillator coupling circuits, by better shielding of the oscillator circuits, and by use of a high-impedance type antenna coil designed so that its resonance frequency (when tuned by the average antenna capacitance) lies outside of the receiving band of frequencies.

In cases where existing receivers either are causing such interfering

radiation, or are affected by it, the following measures should be tried:

- (1) Install an r.f. filter in the power-supply circuit of the receiver affected.
- (2) Install a good noise-reducing antenna on the receiver causing the radiation.
- (3) Realign the radiating receiver to a new i.f., also readjusting the gang condenser trimmers and low-frequency pad correspondingly.
- (4) Reduce the oscillator grid-leak resistance value.
- (5) Reduce the excitation (plate voltage) of the radiating oscillator.
- (6) Position the leads of the radiating receiver so as to reduce oscillator-antenna coupling.
- (7) Reduce the size of the antenna used with the receiver troubled by the interference.
- (8) See that a good ground is used with the radiating receiver.
- (9) Completely shield the oscillator stage, and filter its supply leads.

The receiver illustrated in Fig. 3, which covers the broadcast band and short waves from 5.1 to 24 mcs. is an example of what may be accomplished in the way of elimination of oscillator radiation by careful design. It is an 11-tube low-radiation superheterodyne receiver designed for shipboard use, in which are incorporated special circuits and features which prevent the oscillator from feeding into the antenna and radiating interference which could be picked up by enemy submarines or surface craft, so disclosing the position of the ship to the enemy. It is designed for use as communications equipment by the Merchant Marine, U. S. Navy, and Signal Corps. In this receiver, oscillator radiation is cut down to such a low point that it cannot be detected 25 feet away. Notice the unusually thorough shielding of the preselector and oscillator coils and circuits by means of separate shielding compartments. Of course, such thorough shielding adds materially to the cost of the receiver, so it is not ordinarily employed on medium-priced home receivers.

Over-all I.F. Feedback Interference

Superheterodyne receivers that employ an i.f. of 175 kc. often are unable to receive 700-kc., 1,050-kc. and 1,400-kc. stations without a strong interfering whistle being heard. This whistle originates through over-all feedback. Some of the harmonics of the 175-kc. i.f. energy passes from the second detector through the output system of the receiver and finds its way back to the input. The *fourth* harmonic of 175 kc. is $4 \times 175 = 700$ kc.; the *sixth* harmonic is 1,050 kc.; and the *eighth* is 1,400 kc.,—all within the broadcast band. A receiver employing an i.f. of 465 kc. can be affected by this trouble at only one point within the broadcast band—at 930 kc.

If this trouble is inherent in the receiver, and if it is important to obtain reception at these frequencies without the accompanying interfer-

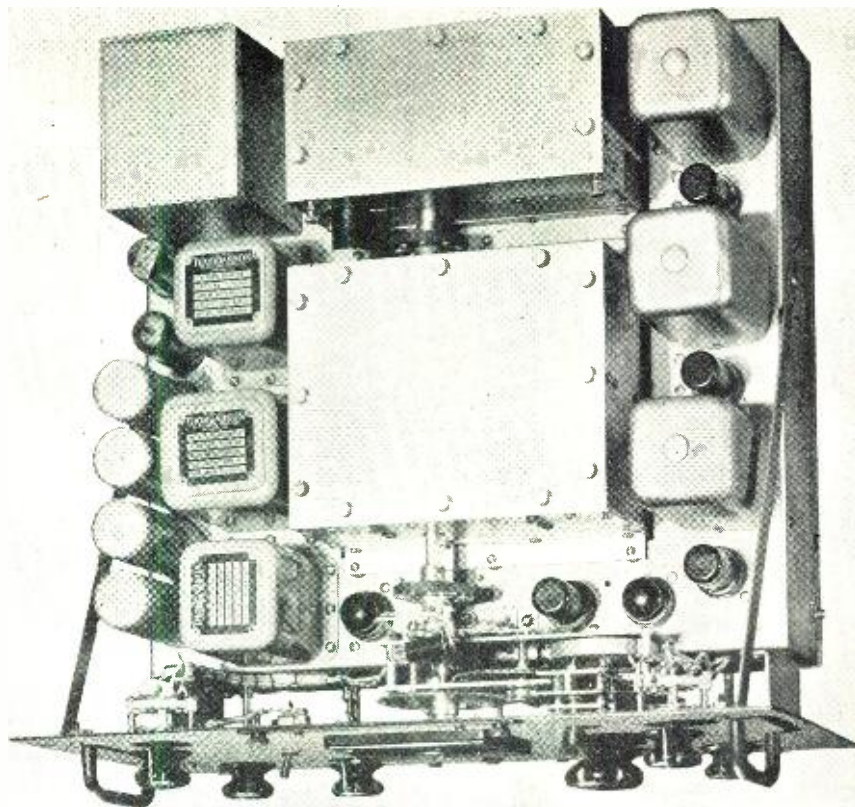

Fig. 3. Special 11-tube low-radiation superheterodyne shipboard-type receiver, incorporating special circuit and other features which prevent the oscillator from radiating to other receivers. Without these special features, radiating interferences would occur, which could be picked up by enemy submarines or surface craft, disclosing the position of the ship to the enemy.

ing whistle, slight retuning of the i.f. transformers will shift the interference to adjacent signal channels where it may not be so objectionable.

Cross-Modulation Within the Receiver

Two signals are said to be *cross-modulated* when the program of the undesired one superimposes itself upon that of the one it is desired to receive. This type of interference is distinctive in that the secondary (interfering) modulation is directly associated with the carrier being received, and is not heard except when the receiver is tuned to the desired carrier. Such cross-modulation interference is prev-

alent in metropolitan areas—in the vicinity of very strong stations. In some cases more than one station may be causing cross-modulation interference on another. Occasionally, cross-modulation even may show up by producing extra responses at random points on the tuning dial, usually appearing as a mixture of two signals and their respective modulations. Cross-modulation may occur in a t.r.f. receiver as well as in a superheterodyne.

Cross-modulation is caused basically by demodulation of a strong interfering signal somewhere in the receiver—usually in the r.f. stages. Nonlinearity of the circuit element or tube, of

(Continued on page 100)

Fig. 4. Audio filter circuit employed in the amplifiers of Philco 200-series high-fidelity receivers to attenuate the 10-kc. beat note prevalent in superheterodyne receivers. This filter cuts off sharply all frequencies over 8000 cycles.

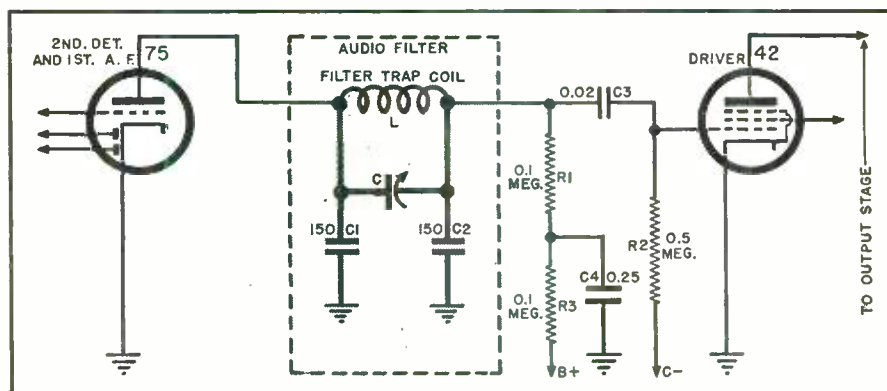

The Cathode Follower

By G. DONALD HENDRICKS

Instructor, AAF

Functional operation of the cathode follower. This circuit will find increasing popularity in the postwar period.

WHEN the present war ends and civilian radio-electronic equipment begins to move off the assembly line, several circuit changes will be included as improvements.

Perhaps the most common circuit with which the radio serviceman, amateur, and engineer will have to contend will be the cathode follower or so-called cathode-coupled stage.

The cathode follower receives its name from the fact that the output is taken off the cathode and consequently the output voltage follows the input signal in phase. See Fig. 1.

Briefly, when the grid goes negative, for instance, the conduction of the tube is reduced. This results in a decrease in current flow through the cathode resistor. A decrease in current will cause a drop in voltage at the cathode. Therefore, it can be seen that if the cathode serves as the output source there will be no phase shift through the stage. The cathode follows the grid—thus the name, cathode follower.

The above statements assume, of course, operation on the linear portion of the tube's characteristic curve.

First used in England, the cathode-coupled stage appears in British patent 419298 (1936), and later patent Number 529044. Its early uses were more or less confined to time-base circuits. At the present time the circuit is being used in video work and for impedance matching. Such a stage enables step-down of impedance (output-stage-to-line) from 10,000 ohms to 52 ohms, for instance, without attenuation of frequencies ranging from 15 cycles to several megacycles.

Principal applications after the war will be:

- 1.—Impedance matching to audio lines.
- 2.—Line to amplifier matching as an "inverted triode."
- 3.—Video coupling in television.

Fig. 2. A.c. condition of Fig. 1.

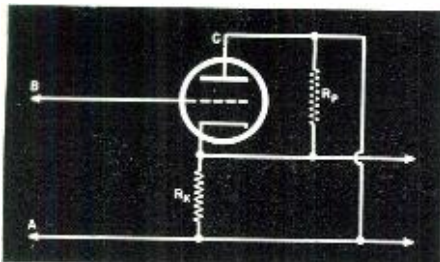

- 4.—FM detection circuits.
- 5.—Automatic frequency-control devices.
- 6.—Oscilloscope probe.

Gain through the stage is less than unity, yet in practice this would represent no more voltage loss than would be encountered in a conventional transformer or plate-load resistance-coupled stage designed to pass the same range of frequencies with high fidelity.

The derivations of design equations are included as appendices. This action was taken for the sake of reading ease. Elimination of derivations from the body of the article prevents clogging the presentation with material which

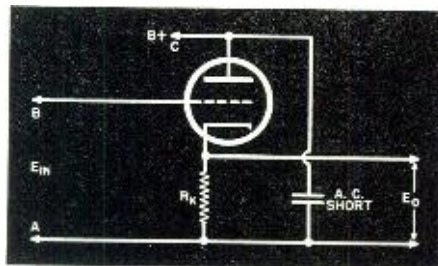

Fig. 1. Cathode-follower circuit.

might cause the average radio man to pass up the article as too difficult. It no doubt will be the average reader who will find the greatest need for a complete mastery of the cathode follower.

It will be seen from an examination of Fig. 1 that the plate is by-passed to ground. This by-pass represents an a.c. short to earth, therefore we are enabled to redraw the circuit as shown in Fig. 2. Fig. 2 shows the a.c. conditions in a cathode follower.

In Fig. 2 it will be noted that a dotted resistor is shown between cathode and plate. This resistor, represented by R_p , is the internal resistance of the tube. In view of the fact that the resistance is between cathode and plate, and the plate is shorted directly to ground (as far as any signal voltage is concerned), it will be seen that the so-called plate resistance is effectively in parallel with the cathode resistor. The cathode resistor will be known henceforth as R_k .

A tube's amplification factor is known as μ (Greek letter mu) and is the ratio dE_p/dE_g at a stated I_p . Expressed in ordinary language μ represents the rate of change in plate voltage with change of grid voltage, with

the plate current remaining constant. The d is often replaced by Δ (Greek letter delta) and means a change, decrement or increment . . . a differential.¹

The μ of a tube may be found in a tabulation of its characteristics as provided by the manufacturer, or it may be found by simple measurements taken from certain circuits, or calculated from a set of tube curves.

Consider a triode whose μ is 10. Plainly stated, adding 50 volts to the plate might change its plate current 2 ma. It would require but 5 volts change on the grid to create a 2 ma. change in the plate current. It is quite logical, therefore, to assume that a voltage change on the grid has the same effect as a voltage change on the plate if the plate voltage is μ times the grid voltage. Thus a voltage E_g when it reaches the plate of a tube is equal to μE_g .

The foregoing explanation has been made to prepare the reader for an equivalent circuit of the cathode follower. Since it has been shown that a voltage change E_g on the control grid multiplied by the tube's amplification factor represents a certain plate voltage change, we can say that the voltage between points BC in Fig. 2 is equal to the voltage AB times μ .

Therefore we are justified in replacing the tube with a fictitious generator between points BC and giving the generator a voltage μE_g . See Fig. 3a.

Fig. 3a is an equivalent circuit which most radio students find easy to understand, while Fig. 3b is the textbook method of showing the same circuit.

Reduced to the equivalent circuit it is much more simple to shake out the necessary design equations and study the theory of operation. Polarity may be assigned to various points in the circuit, and certain voltages or results calculated.

A clear method of considering feedback in the cathode follower is as follows:

When the input signal goes positive, the grid is given a plus potential with respect to the cathode. An increase of grid voltage, however, causes the tube

¹ The mathematically rigorous d represents an infinitesimally small change while Δ represents a larger change. Δ is most common in graphical representations relative to vacuum tube equations. Thus we state the equation as $\Delta E_p/\Delta E_g$ with $I_p = K$ (K is a constant.)

to conduct more heavily. Greater conduction causes an increase in cathode potential. When the cathode goes positive it effectively reduces the initial upward swing of the grid by reducing the actual potential difference between the grid and cathode. Thus we say that degeneration takes place. Controlled degeneration reduces distortion and therefore improves the output fidelity of the stage. Degenerative feedback is an important feature of the cathode follower.

For the sake of identity, feedback in the stage will be called e' (e prime). Taking e' into account, and calculating stage gain, we find the following relations, from the equivalent circuit:

$$e_g = e_{in} - e'$$

$$i_b = \frac{\mu e_g}{R_p + R_k}$$

$$e_o = i_b R_k$$

Gain is a ratio of output voltage to input voltage, or

$$G = \frac{e_o}{e_{in}} \cong \frac{R_k}{\frac{1}{G_m} + R_k} \dots \dots \dots (1)$$

Equation (1) is approximate and serves for design purposes. Appendix 1 and 2 give two rigorous derivations of

E_p	Plate voltage
e_g	Grid voltage
e_{in}	Input voltage
e'	Feedback voltage
e_o	Output voltage
μ	Amplification factor
G_m	Mutual conductance
R_p	Plate resistance
R_k	Cathode resistor
G	Gain (voltage)
d	Differential
Δ	Change in
i_b	Plate current
Z_o	Output impedance
Z_i	Impedance to be worked into
\gg	Much greater than
\therefore	Therefore
\sim	Alternating signal source
\cong	Approximately equal to

Table 1. Definition of symbols used.

the expression for gain as worked out using Figs. 3a-b. Both evolve into equation (1) when certain assumptions are made.

In fact, it may be shown that the gain of a cathode-coupled stage is equivalent

Fig. 5. Circuit which may be used to couple a low-impedance source into a high-impedance circuit.

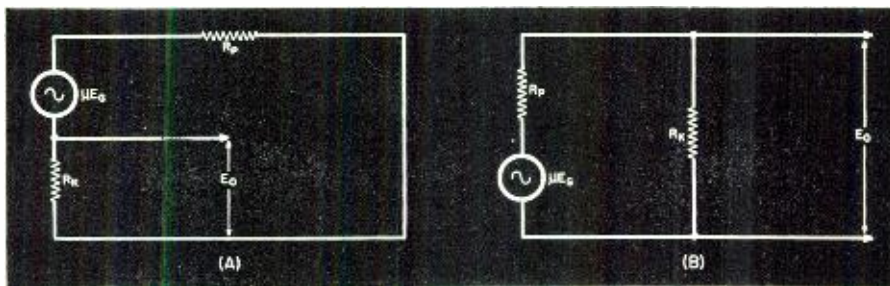
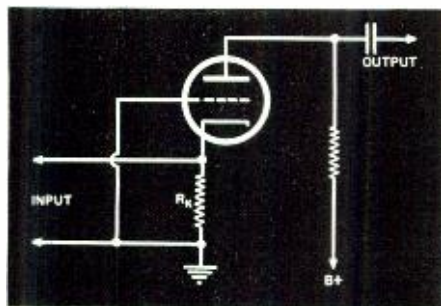

Fig. 3. Equivalent circuits of Fig. 1. (A) The form familiar to most radio students; (B) The same circuit as it appears in present-day textbooks.

to an ordinary plate-load coupled stage using a tube whose amplification factor is $\mu/(\mu+1)$, or less than unity, and whose plate impedance is $1/(\mu+1)$ times the normal plate impedance.

While the above statement is obviously true upon inspection of appendix 1, the simple substitutions are given here for the benefit of the reader.

The equation for gain in an ordinary plate-load coupled stage is:

$$G = \mu \cdot \frac{R_k}{R_p + R_k} \dots \dots \dots (2)$$

If the amplification factor (μ) of this stage is $\mu/(\mu+1)$ and the plate resistance is $R_p/(\mu+1)$, then substituting in equation (2) gives:

$$G = \frac{\mu}{\mu + 1} \cdot \frac{R_k}{\frac{1}{\mu + 1} \cdot (R_p + R_k)}$$

$$= \frac{\mu}{\mu + 1} \cdot \frac{R_k}{\frac{R_p}{\mu + 1} + R_k} \dots \dots \dots (3)$$

If $\mu \gg 1$, then we may say without appreciable error that $\mu/(\mu+1) = 1$ and that $R_p/(\mu+1) = R_p/\mu$. This assumption is made by considering μ much greater than 1. It is known, however, that μ/R_p equals G_m . Therefore R_p/μ equals $1/G_m$.

Completing the rewriting of equation (2) we find that gain is equal to

$$\frac{R_k}{\frac{1}{G_m} + R_k}$$

which is found to be identical with equation (1), the expression for the gain of a cathode follower.

It is found from the above expressions that the gain approaches unity as the cathode resistor (R_k) becomes large compared to R_p . It is noted in experiments with both high- and low- μ triodes (6SF5 and 6L5-G with a μ of 100 and 17 respectively), that the stage gain changes very slowly with varying values of cathode resistances.

From equation (3), it can be seen that the resistive circuit is equivalent to two resistors in parallel—the fictitious resistance $R_p/(\mu+1)$, and R_k . See Fig. 4.

If R_k is much greater than $R_p/(\mu+1)$, and μ is much greater than 1, then

$$Z_o \cong R_p/\mu \cong 1/G_m$$

This expression affords a convenient

method of determining whether a particular tube will offer the required output impedance.

The above conditions have led to bold statements that an impedance match to low-ohm lines will be close enough to enable almost any cathode resistor to be used. This is untrue, however, since it is quite obvious that the tube must be operated upon the straight portion of its curve.

It is possible to apply the calculated equations only as long as the stage is operated class A. It is also known that a correct impedance match for video frequencies must result in the output stage presenting an image of the line's impedance looking back into the stage.

A new analysis would be necessary if improper bias were used, or if the stage is to be driven to the extent that the grid draws current.

The equation for R_k is worked out

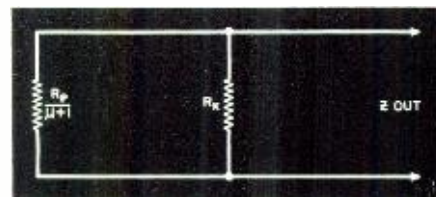

Fig. 4. Circuit used to determine the output impedance of the cathode follower.

in appendix 3. It is found that in order to match an impedance Z_i we must make the impedance of our circuit equal to Z_i . Therefore $Z_o = Z_i$.

Setting up the expressions and working through we find that in order to make Z_o equal Z_i we must change the variable R_k . Solving for R_k , the equation which will satisfy the above statement is:

$$R_k = \frac{Z_i}{1 - Z_i \cdot G_m}$$

An interesting basic sidelight on the cathode follower is to be found in a statement by F. P. Kenyon in 1938. Mr. Kenyon in one of a series of Ken-o-Talks (No. 9) discussed a preamplifier for low level-high gain stock use.

Mr. Kenyon said, in part: "The circuit possesses numerous advantages over the conventional preamplifier. The first two stages are of the standard resistance-coupled type, but the output stage is somewhat different. This stage is of the type sometimes called a cathode follower. The plate is connected directly to "B" plus and

(Continued on page 98)

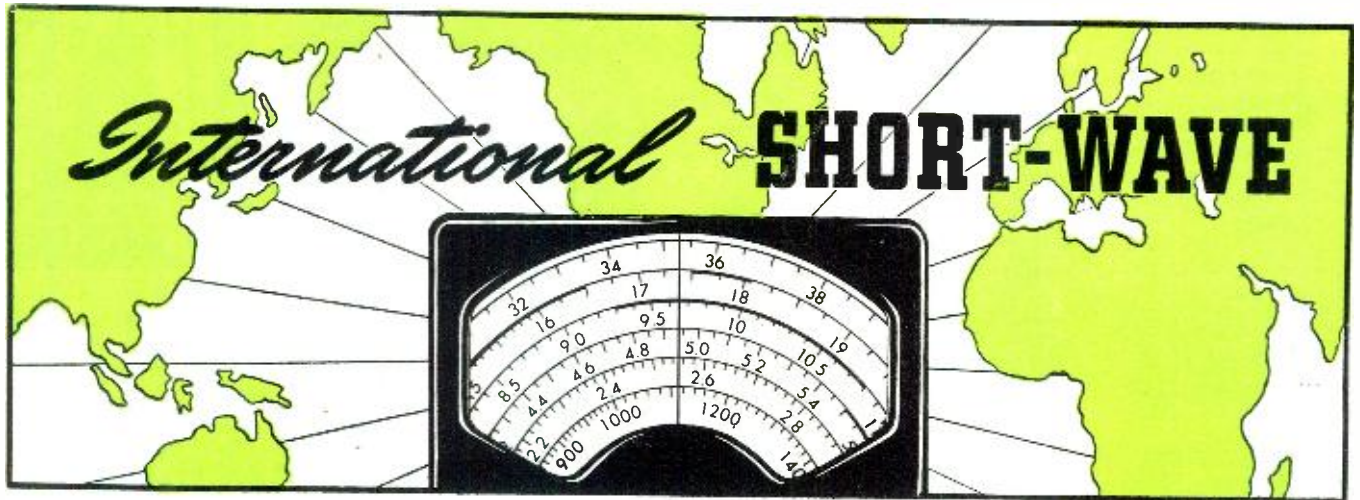

Compiled by KENNETH R. BOORD

ONE of the most interesting reception reports yet received by INTERNATIONAL SHORT-WAVE is that which came in a few days ago from W. N. Caldwell, Riley Street, Suva, capital of the far-distant Fiji Islands in the Pacific. He writes:

"As station identifications frequently are missed, not all are recorded; it would take weeks to get them all. San Francisco comes in very strong, especially the Philippine Commentator and the Armed Forces programs. The one from Australia is especially strong. There are so many stations broadcasting in German, French, Italian, Japanese, Hindustani, Chinese, and other languages that it is difficult to say which one you are tuned to unless you 'hang on' to the end—in which case you may miss other stations, broadcasting in English. This listener confines himself to news in English. Morse is used on practically all the broadcast bands at present and makes it very difficult, but it's wartime and we must expect this."

Mr. Caldwell writes that he uses a Hammarlund HQ-120, with an ordinary "L" Marconi antenna about 75-feet high, directed North.

Here is a two-day log of newscasts in English picked up in October, 1944, submitted by Mr. Caldwell. Fiji time is 12 hours ahead of GMT; I have converted his local time to EWT in the following:

- 15.33—San Francisco, daily, 9, 10, 11 p.m. (S-3, good).
- 9.51—London, daily, 12:30 a.m. (S-2).
- 15.12—Tokyo, 12:45 a.m. (S-2, jammed).
- 15.20—Tokyo, 12:45 a.m. (S-3, good).
- 9.50—Various Spanish-speaking stations, 1 a.m. (S-2 to S-5).
- 9.67—South American and Mexican stations, 1 a.m. (S-2 to S-5).
- 9.85—U.S.A., daily, jammed by Morocco, 1 a.m. (S-3).
- 15.12—Tokyo, daily, 1:15 a.m. (het., S-2).
- 11.90—Tokyo, daily, 1:15 a.m. (S-2 and S-3, clear).
- 9.65, 9.69, 12.04, 7.12, 15.42, 11.95,

and 11.82—London, heard daily, 2, 3, 4, 5 a.m. (S-1 to S-4); some London stations are always heard well at 1:45 a.m.; the 9.65 frequency is jammed by Chungking.

7.60—WNRA, New York, heard with news in German, French, and Italian at 2:15, 2:30, and 2:45 a.m., respectively (S-3).

9.50—San Francisco, daily, 2.45 a.m. (S-3 and S-4).

11.90—Tokyo, 2:45 a.m., *messages to Canada from prisoners of war* (S-3-4).

11.72—Armed Forces Radio, San Francisco, 1 a.m. (S-5).

15.23—Berlin, Germany, 4, 5 a.m. (S-1).

7.29—San Francisco, Philippine news, 6 a.m. (S-3).

11.78—Saigon, French Indo-China, 6:30 a.m. (S-5).

15.29—San Francisco, 3, 4 p.m. (S-1 and S-3).

7.30—New Delhi, 3:30 p.m. (S-3).

9.63—New Delhi, 3:30 p.m. (S-3).

9.63—London (General Forces Program), 7 a.m. (S-4).

9.25—Australia Armed Forces Radio, sports news, 3:15 a.m. (S-4 and S-5).

7.30—San Francisco, for Philippines, 3:15 a.m. (S-6).

9.60—San Francisco, for Philippines, 3:15 a.m. (S-5).

11.87—U.S.A., 3 a.m. (S-2).

Moscow in the 25-, 19-, and 31-meter bands heard with news at 8 a.m., 5 a.m., and 7:30 a.m.

(EDITORS NOTE: We expect before long to have details concerning the operations of VPD2, Suva, 6.135 mc., which is now heard best with an English newscast at 4 a.m. EWT, Sundays only.)

* * *

RADIO EIRE

Radio Eire was heard recently coming on at 4:58 p.m. Asked for reports and that they be sent to "Radio Eire," Chrysler Building, New York City. Reports addressed there will be forwarded by the Consulate General of Ireland to the Department of Posts and Telegraphs, Dublin, by which the Irish radio service is operated. Canadian listeners can write to "Radio Eire," Ottawa, Ontario, Canada (which

we presume is the address of the Consulate General of Ireland for the Dominion of Canada).

This station is reported regularly by Harris, Massachusetts, and others in the eastern United States. It is heard irregularly by your short-wave editor. The station seems to come on the air any time between 4:58 and 5.10 p.m., and signs off any time between 5:14 and 5:35 p.m. The news is generally given at the beginning of the broadcast, and is followed by sports news. The news is worldwide in nature. This appears to be the only short-wave transmission from Ireland at the present time, and it is believed this station is located in Athlone.

Leo T. McCauley, Consul General in New York, informs me that the transmissions are at present on an experimental basis. My inquiry to "Radio Eire" in New York has been forwarded to Dublin, and I hope to have details on the Irish short-wave service shortly.

* * *

REPORT FROM CANADA

The first report received from a reader in Canada comes from Albert E. Bromley, Toronto, Ontario, who reports as follows:

ZNR—12.100, Aden, Arabia, heard with a terrific signal of 15 decibels above S-9, at 1 p.m. to signoff at 1:16 p.m.; identification in English at 1:15 p.m. as ZNR, and wavelength in meters. Stated they were on every night. The program consisted of stringed-instrument orchestra and a man singing in the typical wailing voice of the East. Have received this station twice since then, but not quite as strong.

CR6RA—9.470, Angola, Portuguese Africa, very weak at 3:45 p.m. Signal faded away at 3:55 p.m.

TAP—9.465, Ankara, Turkey, heard at 3:20 to signoff at 3:56 (Sunday), 5 decibels above S-9. No English spoken; the program consisted of piano selections and then a woman announcer followed by two men announcers giving the news. Slight interference.

PCJ1—5.930, Netherlands West In-
(Continued on page 84)

AROUND THE CLOCK WITH THE WAR NEWSCASTS IN ENGLISH

EWT	LOCATION	CALL	FREQ.*	EWT	LOCATION	CALL	FREQ.*	EWT	LOCATION	CALL	FREQ.*
MORNING											
7:00 a.m.	London	GSB GWC GWE GSV GSF GRG GSH GRF GSD	9.51 15.07 15.43 17.81 15.14 11.68 21.47 12.09 11.75	1:00 p.m.	Tokyo	JVW3	11.725	10:30 p.m.	Melbourne	VLC4	15.315
				1:00 p.m.	London	JZK GRY GVW GSI CKRX	15.16 9.60 11.70 15.26 11.72	10:45 p.m.	Leopoldville (Relays BBC)	RNB	9.783
				1:30 p.m.	Winnipeg			10:45 p.m.	London	GRH GSL GSU GRC GRW	9.825 6.11 7.26 2.88 6.15
7:40 a.m.	Moscow		11.80 15.75 10.44 11.94 9.50	2:00 p.m.	Tokyo	JVW3	11.725	11:00 p.m.	Colon (Panama)	HP5K	6.005
				2:00 p.m.	London	JZK GRY GVW GSI	15.16 9.60 11.70 15.26 11.94	11:00 p.m.	Berlin	DXJ DXP CKRO	7.24 6.03 6.15
8:00 a.m.	Shepparton (Australia)		9.615	2:30 p.m.	Moscow			11:30 p.m.	Winnipeg		
8:20 a.m.	Moscow		15.75	2:45 p.m.	Brazzaville	FZI	9.44	11:40 p.m.	Tokyo	JZJ JLT3 DXJ	11.80 15.225 7.24
9:00 a.m.	Manila	PIRM	6.14 9.64	3:00 p.m.	Berlin		9.590	12:00 midnight	Berlin	DXP DXB	6.03 9.61
9:00 a.m.	Tokyo	JVW3 JZK JZI	11.725 15.16 9.535	3:30 p.m.	New Delhi	VUD5	7.30 9.630 10.338	* * * *			
9:00 a.m.	London	GSP GSV GWC GWE GSF GSH JZHA	15.31 17.81 15.07 15.43 15.14 21.47 9.47	3:45 p.m.	Bern	HEO4	10.338	AFTER MIDNIGHT			
9:00 a.m.	Hongkong			4:45 p.m.	London	GSI GVW GRY GRJ FZI	15.26 11.70 9.60 7.32 11.97	12:30 a.m.	London	GSL GSU GRH GRC RNB	6.11 7.26 9.825 2.88 9.783
9:30 a.m.	Berlin	DJB DXR	15.20 11.760	4:45 p.m.	Brazzaville			12:30 a.m.	Leopoldville (Relays BBC)		
10:00 a.m.	Saigon	R.S.	11.78	5:45 p.m.	London	GRH GVZ GSU GSL	9.825 9.64 7.26 6.11	1:00 a.m.	Tokyo	JZJ JZK DXJ	11.80 15.16 7.24
10:00 a.m.	Tokyo	JVW3 JZK JZI	11.725 15.16 9.535	* * * *				1:00 a.m.	Berlin		
10:00 a.m.	Chungking	XGOY	9.646 7.155	EVENING				1:15 a.m.	Shepparton Melbourne Hsinking	VLC4 VLG3 MTCY	15.315 11.71 15.33
10:00 a.m.	Berlin	XGOA DJR	9.73 15.340	6:00 p.m.	Quito	HCJB	9.953 12.445	1:30 a.m.	Suva (Sun. only) (Fiji Islands) (Relays BBC)		
10:00 a.m.	Hsinking	MTCY	5.710 6.125	6:20 p.m.	Tokyo	JLT3 JVU3	15.225 11.897	2:00 a.m.	London	GSD GSB GWC GVU GSP GRG GVZ GRM GWD GRU GRH GSU	11.75 9.51 15.07 11.78 15.31 11.68 9.64 7.12 15.42 12.04 9.82 7.26
10:15 a.m.	Melbourne Sydney	VLG VLI9	9.58 7.28	6:45 p.m.	London	GVZ GRH GSU GSL	9.64 9.825 7.26 6.11	2:00 a.m.	Suva (Sun. only) (Fiji Islands) (Relays BBC)		
10:45 a.m.	Saigon	R.S.	11.78	6:47 p.m.	Moscow			2:00 a.m.	London		
11:00 a.m.	Tokyo	JVW3 JZK XGOY	11.725 15.16 9.646	7:00 p.m.	Berlin	DJD DXJ DXP	11.77 7.24 6.03	2:00 a.m.	London		
11:00 a.m.	Chungking	XGOY	7.155	7:20 p.m.	Tokyo	JLT3 JVW3	15.225 11.725	2:30 a.m.	Hsinking	MTCY	15.33
11:00 a.m.	Ceylon (Relay of BBC)		4.90	7:25 p.m.	Brazzaville	FZI	11.97	2:00 a.m.	Tokyo	JZJ JZK JZK	11.80 15.16 11.80
11:00 a.m.	Stockholm	SBT	15.155	7:30 p.m.	Winnipeg	CKRX	11.72	3:00 a.m.	London	GSB GSD GRG GSW GSP GRD GRM GVZ GWD GRV GRH GSN	9.51 15.07 11.68 7.23 15.31 15.45 7.12 9.64 15.42 12.04 9.82 11.82
11:00 a.m.	Shepparton Melbourne	VLC6 VLG	9.615 9.58	7:30 p.m.	Berlin	DJD DXP	11.77 6.03	2:30 a.m.	Tokyo	JZJ JZK JZK	11.80 15.16 11.80
11:00 a.m.	London	GRV GSP GWC GVU GRG GSV GSH GRF GSD GWD VUD2	12.04 15.31 15.07 11.78 11.68 17.81 21.47 12.09 11.75 15.42 6.19 9.590	8:00 p.m.	Moscow		11.94 9.48	3:00 a.m.	Tokyo	JZK JZK	11.80 15.16
11:00 a.m.	New Delhi			8:15 p.m.	Chungking	XGOY	11.905	3:00 a.m.	London	GSB GSD GRG GSW GSP GRD GRM GVZ GWD GRV GRH GSN	9.51 11.75 11.68 7.23 15.31 15.45 7.12 9.64 15.42 12.04 9.82 11.82
11:45 a.m.	Berlin			8:15 p.m.	Leopoldville	RNB	9.783	3:00 a.m.	London		
* * * *											
AFTERNOON											
12:00 noon	London	GRP GVW GSP GSI	17.87 11.70 15.31 15.26	8:00 p.m.	Berlin	DJD DXP	11.77 6.03	4:00 a.m.	Suva (Sun. only) (Fiji Islands)	VPD2	6.135
12:00 noon	Chungking	XGOY	9.646 7.155	8:00 p.m.	Moscow		11.94 9.48	4:00 a.m.	American Broad- caster Somewhere in Australia Melbourne Perth	VLC2 VLR VLW3	9.68 9.58 11.83
12:00 noon	Moscow		15.75	8:15 p.m.	Chungking	XGOY	11.905	6:00 a.m.	Shonan (Singapore)		9.555
12:00 noon	Tokyo	JVW3 JZK	11.725 15.16	8:15 p.m.	Leopoldville	RNB	9.783	6:30 a.m.	Saigon	R.S.	11.78
				9:00 p.m.	Berlin	DXJ DXP	7.24 6.03	6:30 a.m.	Shonan (Singapore)		9.555
				9:00 p.m.	London	GSL GSU GRC GRH RNB	6.11 7.26 2.88 9.825 9.783	6:30 a.m.	Shonan (Singapore)		
				9:10 p.m.	Leopoldville						
				9:20 p.m.	Budapest	HAT4	9.125				
				9:30 p.m.	Bern (or 9:45)		7.38 6.345 9.539				
				9:45 p.m.	New Delhi	HEI4 VUD5	9.539 7.300				
				9:45 p.m.	Melbourne	VLC4	15.315				
				10:00 p.m.	Berlin	DXJ DXP	7.24 6.03				
				10:15 p.m.	Djarkarta		18.135				
				10:25 p.m.	Budapest	HAT4	9.125				

* To convert frequency to meters divide 300,000,000 by the frequency in cycles-per-second.

THEORY AND APPLICATION OF U.H.F.

By MILTON S. KIVER

Part. 9. Covering the principles and operation of commonly employed methods used to obtain energy from cavity resonators.

IN THE previous article on cavity resonators their development from either wave guides or transmission lines was shown, methods of excitation were explained, and the electric and magnetic field distribution investigated. In the present article more of the properties will be examined in order to complete the picture of cavity resonator action in ultra-high-frequency apparatus.

As pointed out in the last installment, electrons passing through the grid-like structure of a cavity resonator will induce electric and magnetic fields within the enclosure of the resonator and if the period of the exciting electrons bears a direct relation to the natural frequency of oscillation of the cavity resonator, then large standing waves will be obtained and correspondingly large amounts of power may be drawn from the enclosure. This power then may be used to excite an amplifier or it may be connected directly to the antenna for radiation.

Output from a cavity resonator that is being excited can be accomplished in three ways. And surprisingly

enough, each method has the same action whether at the ultra-high frequencies or merely on an ordinary low-frequency transmitter. The simplest and most obvious method is to just allow the energy in the cavity resonator (or coil and condenser) to radiate from the apparatus itself. This, of course, is generally undesirable, but nonetheless represents a transfer of energy from the tuned circuit (or resonant chamber) to some outside receiver.

A better method of obtaining energy from a cavity resonator is comparable to the capacitive method used on low-frequency circuits and illustrated in Fig. 1A. Here the wire from the condenser is placed at a point on the coil where the r.f. voltage is high in order that the most energy may be transferred. Moving the tap down toward the grounded end of the coil will decrease the amount of voltage taken off, and thus enable us to have any voltage, from a minimum of zero to a maximum that is determined by the voltage fed to the coil.

To apply this analogy to a cavity resonator, it is first necessary to find a point of high value in the electric field, this being analogous to a high r.f. voltage. From what has been mentioned in the article on wave guides and the last article, it is safe to assume that a high electric field would not be found near any of the conducting walls. To illustrate this, refer to the diagrams that have been reprinted here from a previous article. Fig. 2A shows the electric field distribution across the width of a cavity resonator, while Fig. 2B represents the same distribution for the length, in this case a half wavelength long. The output device may be placed at any point where the electric field intensity is other than zero.

The device itself that is used to receive the energy is drawn in Fig. 3. To make this type of probe, all that is needed is a coaxial transmission line with the inner conductor extending a little beyond the outer cylindrical conductor. The hole in the resonator through which this cable actually may pass is usually threaded so as to enable the outer conductor of the coaxial line to be screwed firmly into place and at the same time make electrical contact with the inner surface of the cavity resonator. The inner coaxial rod then extends well into the chamber itself and so comes into contact with the electric field. The electrons in this center rod then will be acted on

by the electric field and thus enable energy to be transferred from the resonator. The other end of the coaxial cable may be attached to the device that will receive this energy, as stated above. In an oscillator, if the cavity

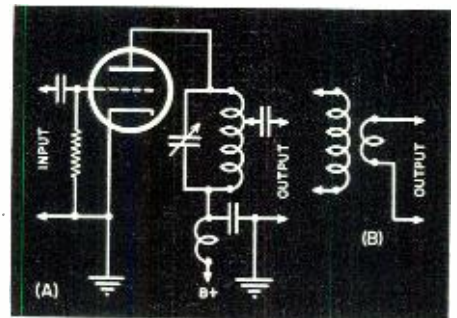

Fig. 1. Methods of obtaining low-frequency energy transfer: (A) capacitive coupling, and (B) inductive coupling.

resonator happens to be the catcher, this energy may be fed back to the buncher resonator and complete the oscillating action. In this case another coaxial line then will be attached to the catcher resonator for output energy.

In the low-frequency capacitive coupling, less energy was taken for the output circuit if the tap was moved down. To accomplish the same results here, all that is necessary is that the probe be moved to a region where the electric lines of force are less intense. This would mean bringing it closer to one of the walls and away from the center of the resonator. This is somewhat difficult to do as it requires that another hole be drilled in order that the coaxial line can be inserted. This detail is merely a mechanical one and whether the process of changing the amount of energy output is more or less difficult at the ultra-high frequencies, the comparison to the action at the lower frequencies is quite evident. In one case there is an actual voltage that is being dealt with; in another there is an electric field of force.

There remains one more method of coupling at the low frequencies and that is by inductive means. Placing a small coil close to an oscillator inductance will transfer energy, as shown in Fig. 1B, from the circuit on the left to the output circuit on the right. Moving the coil closer will result, up to a certain point, in more energy being available at the antenna. Increasing the distance between the coils naturally will produce the opposite effect.

Fig. 2. (A) Cavity resonator, showing the electric field distribution along the X axis. (B) the same resonator as in (A), showing how the electric field varies as the wave travels down the enclosure.

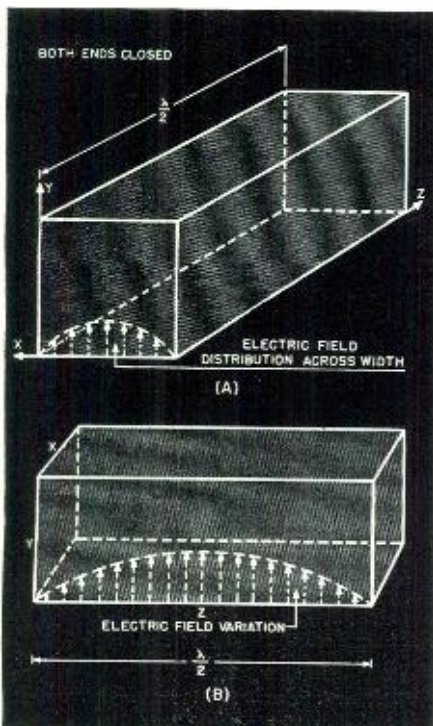

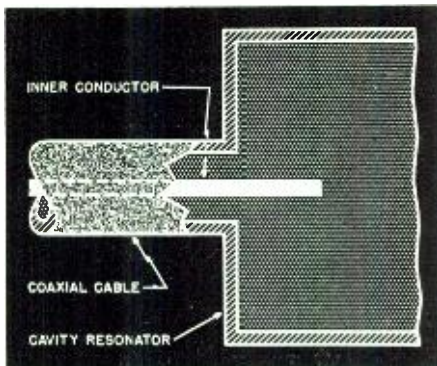

Fig. 3. An ultra-high-frequency method of capacitively coupling a cavity resonator.

This is the well-known action at the low frequencies. The high-frequency analogy means that magnetic lines of force will have to be considered. These form closed loops within the resonator and at the same time are everywhere at right angles to the electric lines of force. This has been mentioned in previous articles and is referred to here to bring these thoughts back to mind.

Now, in order for a changing magnetic field (such as might be obtained in a resonator) to induce a voltage in a metallic probe, best results usually will be had if this conductor is in the form of a loop. The more turns of wire in this loop, the greater the induced voltage. Experimentally this loop can be moved about in the cavity resonator until the point of maximum coupling takes place with the magnetic field. By moving the coil either back or forth about this position, less coupling may be obtained in a manner quite analogous to the low-frequency apparatus. A diagram of a magnetic probe that may be made from a coaxial cable is given in Fig. 5. Although it might be desirable to use several loops, these are not made to fit easily within the small volume of a cavity resonator. One loop, as pictured, usually will provide enough pickup for most purposes.

Both methods of coupling to cavity resonators may be used to remove energy. Which is actually chosen depends, as at the low frequencies, on the particular circuit in use. Actually, neither method exists by itself. With capacitive coupling, we get some inductive coupling and with the latter method, a great deal of capacitive coupling likewise exists. For best operation, loose coupling is desirable. By inserting this metallic probe deeply into the cavity resonator, it is possible to alter to some extent the configuration of the fields here and the end result will be a change, sometimes not too slight, in the resonant frequency of the resonator. To take this into consideration, the resonant frequency of the resonator is determined with the probe in position.

For the final comparison between cavity resonators and the more familiar tuning circuits, let us determine the components of the Q of these ultra-high-frequency tuners. It will

be recalled that one reason ordinary coils and condensers are not used here is due to the fact that the Q or selectivity (and efficiency) of these units decreased to small values. This has been explained in detail in previous articles. It might be interesting, however, to see just how the Q of a cavity resonator is deduced since nowhere in its construction can any inductance (as such) be found. Of course, from what has been given on transmission lines, it can be seen easily that what we actually have in a resonator is distributed resistance, capacitance, and inductance, which take the place of lumped constants.

Returning to the symbol Q itself, it was shown previously that this was equal to the ratio:

$$\frac{\text{Inductive Reactance}}{\text{Resistance (a.c.)}}$$

or stated in a simple mathematical formula:

$$Q = \frac{\omega L}{R}$$

The above resistance is not what would be read with an ohmmeter, since this reading would pertain only to d.c. resistance in the coil. It is the total resistance, both a.c. and d.c., and increases with frequency. The increase is brought on by a combination of the following causes:

1. Skin effect, which causes the current to concentrate near the surface of the conductor as the frequency rises.
2. Dielectric losses causing leakage since insulators at low frequencies may (and often do) become conductors at high frequencies.
3. Distributed capacitance between turns.
4. Eddy currents in the conductors.

Now, it is possible to take the above definition of Q and to express it in slightly different terms, having the same meaning. This follows from the fact that the energy put into the coil is divided into two parts: that which is stored in the magnetic field due to the action of the coil, and that energy which is lost because of the inherent resistance of the wires that form the coil. It can be shown by mathematical reasoning that the following ratio:

$$\frac{\text{Energy stored per cycle}}{\text{Energy dissipated per cycle}}$$

Fig. 4. The sequence of energy transfer between magnetic and electric fields in a low-frequency circuit. (A) Condenser being charged from battery source. (B) Discharge of condenser through an inductance coil, setting up a magnetic field. (C) Showing condition after the magnetic field has collapsed and condenser polarity has been reversed.

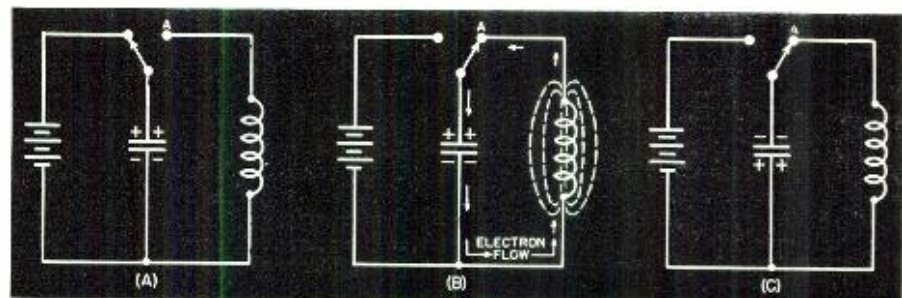

also can be made equal to Q. From this it can be deduced that a coil that has a high Q is more efficient (has less loss) than one with a lower Q, a fact previously brought out. Here, however, it is a little more obvious. Again the matter of convenience prevents the use of the formula at the lower frequencies.

To apply the above formula to a cavity resonator, it is necessary to determine where the energy is stored and where it is lost. The first condition is simple, since any energy that is contained in a cavity resonator can be found in the electric and magnetic fields. The energy is contained first in one field and then it changes over gradually into the energy of the other field. This self-same situation is obtained at the lower frequencies also,

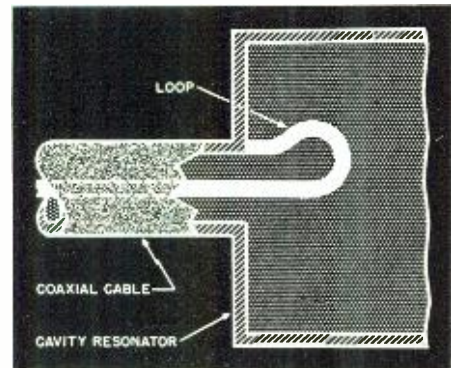

Fig. 5. Using a coaxial cable as a means of inductively coupling a cavity resonator at the ultra-high frequencies.

as can be shown quickly by the following simple example. In Fig. 4 is shown the circuit of a parallel coil and condenser combination. By means of a switch it is possible to introduce energy into the circuit from a battery. In this case the condenser is the recipient of this energy. If the switch is opened then, the condenser retains its charge and energy may be considered as residing in the electric field between the plates. By moving the switch over to position A, the electrons will flow from the condenser to the coil and a magnetic field will build up around this coil. In a short period of time the entire energy that was contained in the condenser will be found in the magnetic field about the coil. The first phase of our process thus has taken place.

As soon as the current stops flowing,
(Continued on page 150)



By **CARL COLEMAN**

A NEW class of license was announced by the Federal Communications Commission to be known as the "Temporary Emergency Radiotelegraph Second Class Operator License." The new license should not be confused with the "Temporary Limited Radiotelegraph Second Class Operator License" which has been known as the "TLT." The new "TET" grade license was announced by FCC in order to relieve the present shortage of radiomen with radiotelegraph tickets and also because of the shortened training course offered at the Maritime Radio Training Schools which may not equip students to pass the higher examinations. The new license restricts the operator from transmitting except for "emergency communications directly related to the safety of life and property at sea."

This license shall be issued to any person who passes the FCC commercial radio operator International Morse Code test of 16 code groups per minute; in addition, obtains a rating

of fifty percent or better on elements 1 and 6 of the commercial radio operator examination; and is found otherwise qualified to hold a radio operator license. This license will be valid only for operation of a ship radiotelegraph station on board a vessel that carries at least one Limited Radiotelegraph Second Class radio operator holding a Temporary Operator License, or a radio telegraph license of higher grade, who maintains at least eight hours of the required watch per day, or one-third of the required watch per day on board such ships and supervises, subject to authority of the master, operation of the ship station.

This license will expire one year from date of issue unless previously terminated by the Commission, and unless otherwise provided for by the Commission, will not be renewed.

The measure, in other words, is a temporary expedient to provide radio operators for the emergency communications which might be necessary

under present conditions aboard U.S. cargo vessels. However, when the need is no longer acute, the Commission will most likely cancel this grade of license, so if you obtain one of these "TET" tickets get started on your way to obtain a "TLT" or regular 2nd class radiotelegraph license.

R. MURISON was in recently for a short vacation while his craft was being refitted. E. K. MacDowell has been "looking into things" up at a new television station operated by Dumont and seems to like that better than some of the other branches of radio. R. Krohem was in with his cargo vessel recently for a few days.

S ELECTIVE SERVICE in New York recently has announced that all former seamen up to 38 years of age who were granted deferments as seamen and then quit, face reclassification into 1-A and immediate induction, unless they return to active sea duty. Shortage of manpower in the merchant marine was responsible for the statement of Col. A. V. McDermott, local Selective Service director, who addressed local boards and appeals agencies.

"The situation has been developing progressively over the last three months and promises to grow even more serious as time goes on."

The chief offenders, he asserted, were men over 30 years of age who have left the sea because of the liberalization of the classification policies in their age group.

ANDREW C. JORGENSEN, recently elected vice president and general manager of Mackay Radio, joined MRT in 1924 as a radio operator. Murray Crosby who has been with RCA as a research engineer has joined Press Wireless. H. Harris has returned to the East Coast again.

After seventeen months of public hearings, the House committee investigating FCC suddenly voted late in November for secret sessions. The broadcast division has been interested in the outcome of the investigation into the sale of WMCA by Donald Flamm to Edward J. Noble. The station was sold four years ago at a price that was reported to be several hundred thousand dollars below its actual value and was claimed by some to have been sold under duress.

AIRWAYS flight radio officers will be interested in an announcement by Boeing of the actual completion of a new postwar transport craft. The new ship is designed to carry 72 day passengers or 36 in berths, is a two deck affair with a cruising speed of well over three hundred miles per hour and a range of well over three thousand miles. It is of the four engine type. Now if they only stop doubling up on the methods of taxes for some of the airline companies maybe they can afford to open up some nice

(Continued on page 136)



"I think it will work all right now, but I wouldn't start listening to any serial stories!"

OHMITE RESISTORS

Many Types and Sizes
Assure the Right Resistor
for Each Control Job

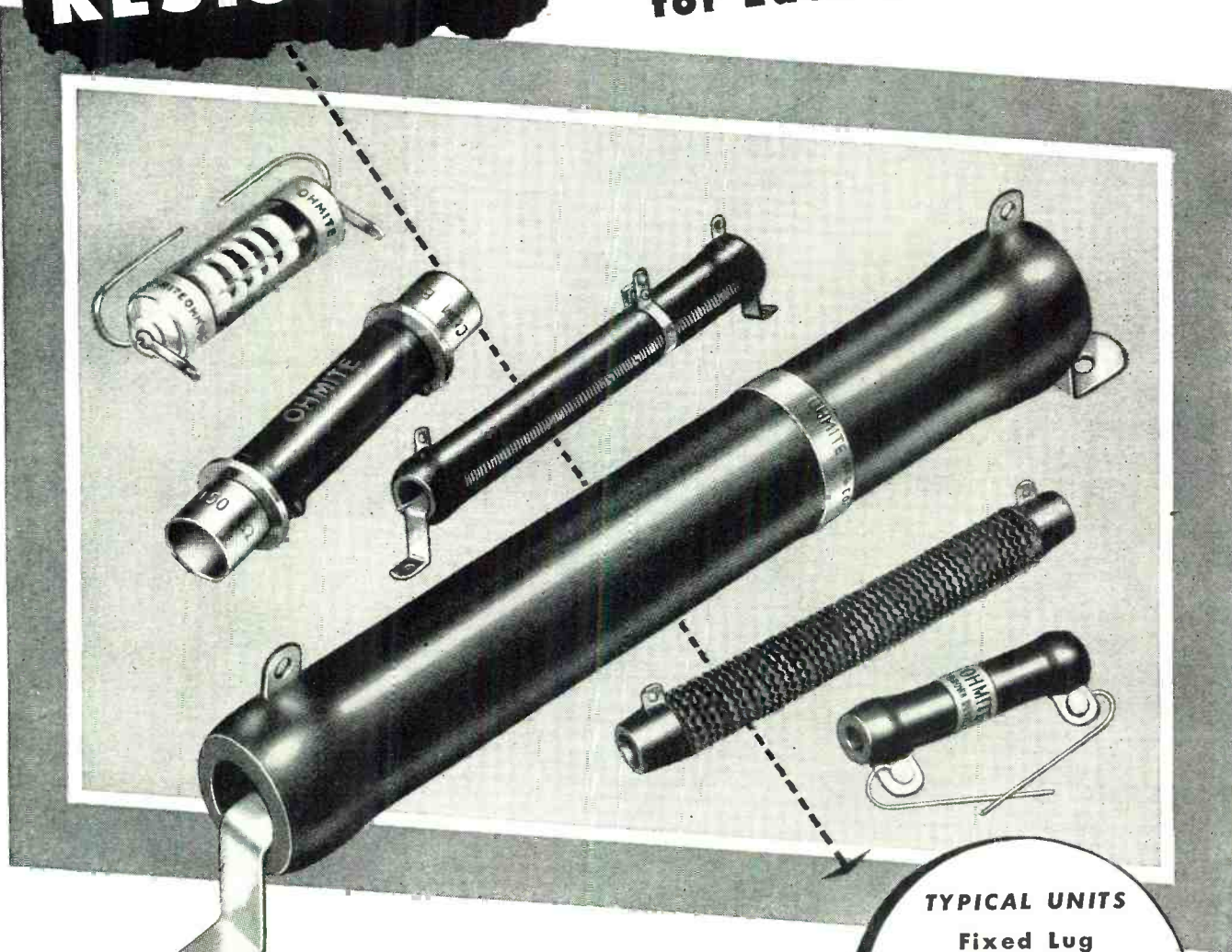

Many critical control problems are being readily and successfully solved with Ohmite Resistors. That's because the extensive range of Ohmite types and sizes makes possible an almost endless variety of regular or special units to meet each need best.

Ohmite core sizes range from 2½" diameter by 20" long to 5/16" diameter by 1" long. Wide selection of stock units are available.

These rugged resistors have proved their worth under toughest operating conditions, in every field of action. Ohmite engineers are glad to help on today's and tomorrow's control problems.

OHMITE MANUFACTURING COMPANY
4884 Flournoy Street • Chicago 44, U.S.A.

TYPICAL UNITS

- Fixed Lug
- "Dividohm"
- Wire Lead
- "Corrib"
- Ferrule
- Edison Base
- Precision
- Bracket
- Non-Inductive
- Tapped
- Cartridge
- Strip

Send for Handy
Ohm's Law Calculator

Be Right with **OHMITE**
RHEOSTATS • RESISTORS • TAP SWITCHES

Set the slide once—read the answer! Solves any Ohm's Law Problem—quickly, easily. Send only 10c in coin to cover handling and mailing.



LARGEST STOCKS

CENTRALIZED SERVICE

From every corner of the Nation . . . come calls to ALLIED for rush delivery of vital radio and electronic supplies.

For it's well known that here are centralized today's largest and most complete stocks under one roof . . . tubes, parts, kits, test equipment, public-address . . . over 10,000 items from all leading manufacturers . . . for training, research, engineering, production and maintenance.

Here, too, are men of experience to give technical assistance or expedite procurement of many diversified needs.

Wherever you are . . . whatever you need . . . call ALLIED first for fast, efficient, intelligent service.

Write, Wire, or Phone Haymarket 6800
ALLIED RADIO CORP.
 833 W. Jackson Blvd., Dept. I-B-5, Chicago 7

Everything
 in RADIO and
 ELECTRONICS

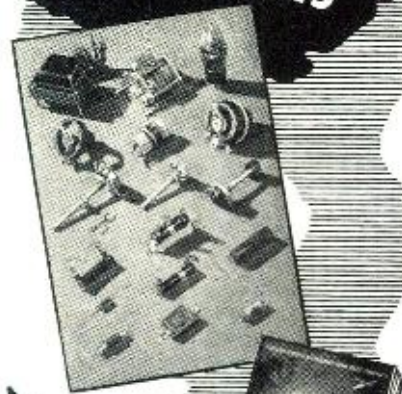

FREE
 Complete
 Up to date
 BUYING GUIDE

REPAIR AND
 REPLACEMENT
 PARTS
 AVAILABLE
 WITHOUT
 PRIORITY



NEW Rapid R-F Resonance and Coil Winding Calculator

New, dual-purpose Calculator devised by Allied for fast and accurate determination of resonance factors and coil winding data. Simple, easy to use. Send for it now. No. 37-955. Price net, only 25c

6 VALUABLE RADIO BOOKS FOR 75c

Specially prepared by technical experts for radio training and for helpful reference. Priced only to cover cost of preparation and mailing.



- | | | |
|---|--|--|
| RADIO BUILDERS' HANDBOOK. Simplified theory and projects. No. 37-750 . . . 10c | RADIO-FORMULAS & DATA BOOK. Handy, pocket-size manual. No. 37-752 . . . 10c | SIMPLIFIED RADIO SERVICING. Short cuts in troubleshooting. No. 37-755 . . . 10c |
| DICTIONARY OF RADIO TERMS. Easy-to-understand definitions. No. 37-751 . 10c | RADIO CIRCUIT HANDBOOK. Schematics and Pictures. No. 37-753 10c | RADIO DATA HANDBOOK Formulas — Tables — Charts No. 37-754 25c |

ALL SIX BOOKS No. 37-799 75c
 Write for Quantity Quotations

ALLIED RADIO CORP., Dept. I-B-5
 833 W. Jackson Blvd., Chicago 7, Illinois

Please send the following items (\$_____ enclosed)

37-750 37-752 37-754
 37-751 37-753 37-755
 All 6 Radio Books Free Catalog Calculator

Name _____
 Address _____
 City _____ State _____



TECHNICAL BOOK & BULLETIN REVIEW

"BEHIND THE MICROPHONE," by John J. Floherty. Published by J. B. Lippincott, Philadelphia. 207 pages. Price \$2.00.

In this book, Mr. Floherty has presented the story of radio as seen by the announcer, producer and actor. He has recalled, amusingly, the early days of radio broadcasting when the handling of emergencies was everyday fare for the station staff.

Equipment breakdowns, temperamental performers and inadequate studios added to the "pioneer" atmosphere of this new venture called radio.

The various services of radio, including news broadcasting, sustaining programs and sponsored time, are discussed simply and nontechnically with the hope that the public will appreciate the work, thought, time, and money that is represented by the fifteen minute "serial" or the two-hour symphony concert.

The structure of the network and its function in radio broadcasting is presented in order that the listener may gain some concept of the magnitude of the job behind the international broadcast, the coast-to-coast pickup or the program originating from some remote spot.

Since Mr. Floherty is not connected with the radio industry his approach is that of the layman to whom this complicated business of radio bears a close resemblance to a three-ring circus, a county fair, and an elaborate carnival all rolled into one. His enthusiasm for his subject and his admiration for the men who "keep it on the air" is manifest in this book.

For those who like to have a "behind the scenes" view of a great industry, this book will prove to be a satisfying and pleasurable experience.

"PRODIGAL GENIUS, THE LIFE OF NIKOLA TESLA," by John H. O'Neill. Published by Ives Washburn, Inc., New York. 322 pages. Price \$3.75.

It is a sad commentary on our ability to judge genius when it is near us, that we fail to accord the honors due a man like Nikola Tesla during his lifetime and only after death do we extend the laurel wreaths and pen eulogies to his memory.

However, if the public is remiss in this matter, it is gratifying to have so sincere a tribute paid to a great man of science as is paid to Mr. Tesla in Mr. O'Neill's biography of him.

Nikola Tesla, to whom the world owes many of the advancements in power and radio engineering, was born of poor parents in a little town of Smiljan, on the Austro-Hungarian border. His father was the pastor of the village church and by the standards of the day, was an educated man. His mother was illiterate, but Tesla gives

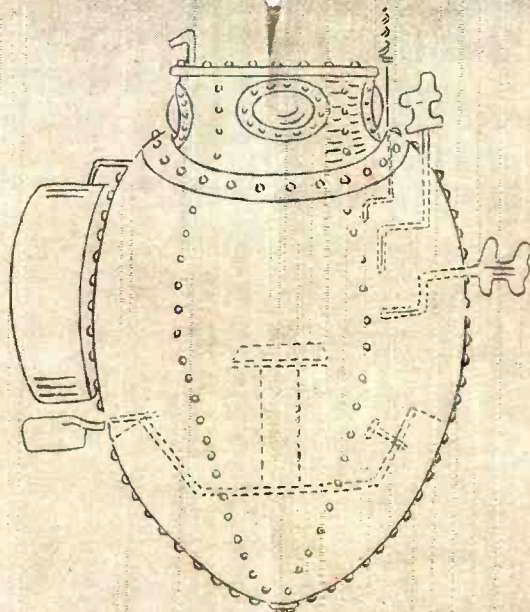

Experience Counts

The unusual craft shown above was the first submarine of the American Navy. Built in 1776 by David Bushnell, it was used against the British warship, "The Eagle" which was lying off New York. Now, "The American Turtle"—that's what it was called—acted like a submarine all right, but that was about all. It didn't sink or damage any ships. Bushnell had a good idea but he simply did not have enough knowledge or experience to make his idea practical.

The moral of this story is: *In the development of the first submarine as in the development and*

manufacture of all products, Experience Counts.

The design and manufacturing experience of THE WARD PRODUCTS CORPORATION has long ago established this company as the leader in the production of automobile and home antennas. Many important design changes pioneered by WARD, have made WARD the recognized pacesetter. All WARD products are quality products, the workmanship of craftsmen of experience, using modern equipment under ideal conditions. For the finest antennas for automobile and home applications, look to WARD!

THE WARD PRODUCTS CORPORATION
1523 EAST 45TH STREET
CLEVELAND 3, OHIO



WARD Antennas



BUY WAR BONDS

MURDOCK RADIO PHONES

War-tested for Dependability!

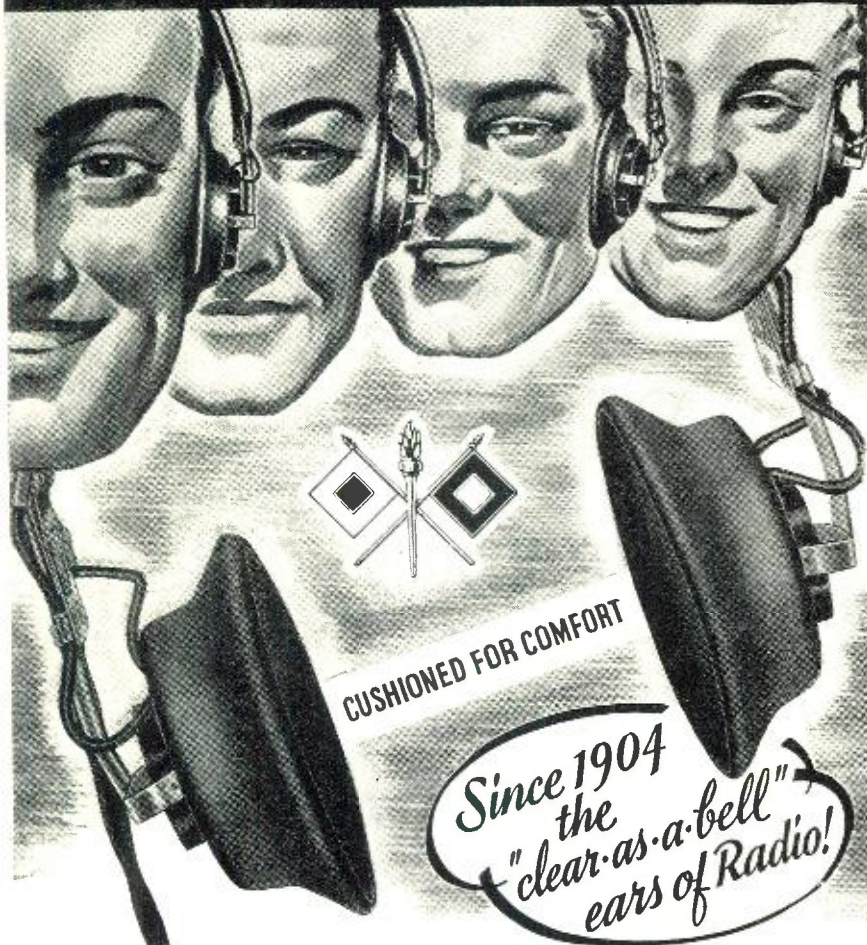

UNIFORM PERFORMANCE—Always
 Laboratory tests alone do not provide all the answers. From warfare conditions—on every fighting front—we at MURDOCK are learning many vital things about Radio Phones that will be of tremendous benefit in building still better equipment for a world at peace.

In war — in peace — MURDOCK RADIO PHONES embody the same traditional quality and dependability that have made MURDOCK a leader in radio hear-

ing performance for 40 years. When you specify MURDOCK for your headset, you are assured of supersensitive, bell-tone clearness built into a rugged, shock-proof unit. Solidly made throughout with no loose parts. Cushioned comfort and lightness make listening a pleasure.

SUB-CONTRACTS INVITED
 Let us help you on Radio Phones and related parts on a sub-contract basis. Your assignment handled with care, speed, and skill.

Write for Catalog Today

WM. J. MURDOCK CO.
 166 Carter St., Chelsea 50, Mass.

her credit for his inventive genius as it was her nimble brain and fingers which devised various means of labor saving in their modest home.

His formal engineering training covered a period of many years during which time he found it necessary to work to supplement the meager stipend his family was able to provide. The dynamic "will to do" which was evidenced in his early career never failed him throughout his life.

He is known as the father of the modern system of power transmission, the discoverer of the rotating magnetic field, and the principle of alternating current. During his lifetime he made a fabulous fortune, refused the Nobel Prize, yet died almost in poverty. Such was the man Nikola Tesla.

The treatment of the story is sympathetic, and in the hands of his close friend, John O'Neill, Tesla lives again in the hearts of his fellow countrymen.

-30-

FORMER RADIO AMATEURS COMMISSIONED S. C. OFFICERS

NINETEEN former radio amateurs received their commissions as second lieutenants together with other members of the 38th Class of Signal Corps Officer Candidate School at graduation exercises at Fort Monmouth, N. J. recently.

The new officers, and their call signs, follow:

K7IWH—Wendell J. Motter, St. George, Utah.

W3IEF—Richard E. Berger, Washington, D. C.

W5GDZ—Troy C. Wooddell, Houston, Tex.

W5HZ—Theodore D. Stallings, Dallas, Tex.

W6BCE—Joe Nightingale, Santa Maria, Cal.

W6PFY—Jay R. Borden, Los Angeles, Cal.

W6SKW—Richard B. Huntington, San Diego, Cal.

W7GQX—Raymond W. Williams, Astoria, Ore.

W7IFW—Kay G. Sears, Seattle, Washington.

W8EFW—Paul M. Cornell, Cleveland Heights, Ohio.

W8QWW—William R. Triplett, Bluffton, Ohio.

W8SRE—Richard A. Jamison, Cleveland Heights, Ohio.

W8TWQ—Frederick W. Walter, Lakewood, Ohio.

W8UBW—Thomas E. Tice, Huntington, W. Va.

W9GSO—Rudolph J. Rosetaritz, St. Louis, Mo.

W9GZU—Ty Rensch, Ramona, South Dakota.

W9JGL—John L. Jones, St. Louis, Mo.

W9NTV—James C. Miller, Rockford, Ill.

W9QBC—James S. Joska, St. Louis, Mo.

-30-

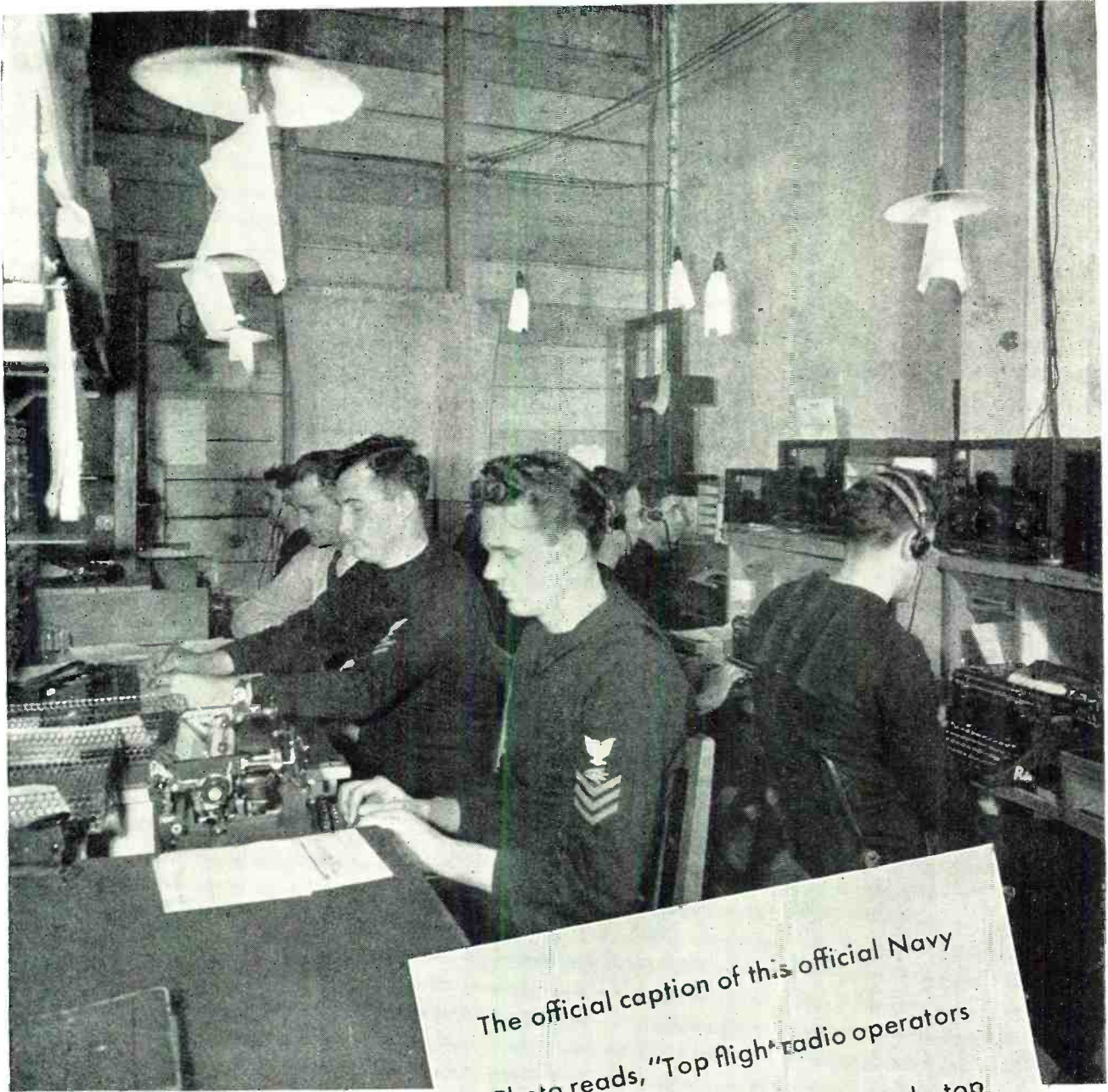

The official caption of this official Navy
Photo reads, "Top flight radio operators
plus top flight equipment equals top
flight performance at an African elec-
tric base for the Italian Front."



NATIONAL COMPANY

MALDEN  **MASS., U. S. A.**

NATIONAL RECEIVERS ARE IN SERVICE THROUGHOUT THE WORLD

February, 1945

65

WHAT'S NEW IN RADIO

New products for military and civilian use.

NEW INTERCOM

In response to the Navy's request for a high speed intercommunicating system, *Executone, Inc.*, 415 Lexington Ave., N. Y., N. Y., has developed a new unit for use aboard the fleet.

The new system can have up to 11 stations and the number of individual



stations is unlimited. Any station may talk with any other station, at adjustable volume, and may communicate with as many other stations as desired. Several pairs of stations can talk simultaneously without other stations being able to overhear or cut in.

Automatic signal lamps show when other stations are busy, and also act as check-ups that the system is in working order. Volume is individually controlled. Each unit is equipped with built-in auxiliaries, such as reserve tubes and power, in case the 110 volt supply, on which the unit normally operates, is cut off. The unit is weatherproofed according to Navy specifications.

COROSEALED MIDGET RELAY

Corosealed relay, which is a midget type relay designed especially for communication, electronics, and aviation applications, has been announced by *Betts & Betts Corp.* These relays are



hermetically sealed in a metal shell, assuring perfect performance under severe conditions of temperature, humidity, pressure, dust, corrosion, and fungi. Units are normally sealed with

content of prefiltered dry air, but can be furnished with inert gas or pressurized content when desired.

This component incorporates a standard octal plug base to facilitate testing. Unit is $1\frac{1}{16}$ " long— $2\frac{3}{8}$ " including prongs.

Coil windings can be supplied for voltage ranges from 1.5- to 70-v. d.c. and are wound to exact number of turns. Every unit is subjected to a 1000-volt breakdown test. Inorganic base plastic insulation minimizes high-frequency loss and assures permanent dielectric and mechanical strength. Contact arrangements offer flexibility in arrangement and handle 2 amps. at 100 watts.

Further details of these relays may be had by writing to *Betts & Betts Corp.*, 551 W. 52 Street, New York 19, N. Y.

AIRCRAFT RHEOSTATS

Two new approved Power Rheostats for aircraft have been announced by the *Ohmite Manufacturing Co.* These new units are made in accordance with



the latest Army-Navy Aeronautical Specifications AN-R-14a (Drawing 3155). They have many well-known *Ohmite* Rheostat features plus new, improved control protection. They are rugged in design and construction to provide uniform electrical and mechanical control, and utmost dependability under all operating conditions.

These new approved AN Aircraft Rheostats are light in weight—lighter than the allowable weight specified. They meet the salt-spray corrosion test, and other critical tests—and operate satisfactorily in the temperature range from -55° C. (-67° F.) to $+70^{\circ}$ C. ($+158^{\circ}$ F.).

There are two sizes: *Ohmite* Model "J" 50-watt, and Model "H" 25-watt. The Rheostats are Linear or Taper wirewound, in various resistances, with "off" position, as required. They are totally enclosed in a compact, corrosion-resisting metal container, complete with knob, as shown.

Further information may be obtained by writing to the *Ohmite Manufacturing Co.*, 4835 Flournoy St., Chicago 44, Illinois.

NEW AMPLIFIERS

A series of amplifiers known as the 101 Types has been offered by *The Langevin Company, Inc.*, 37 West 65th Street, New York, N. Y. These amplifiers are designed for commercial continuous service, and meet the need for medium gain, high-power bridging

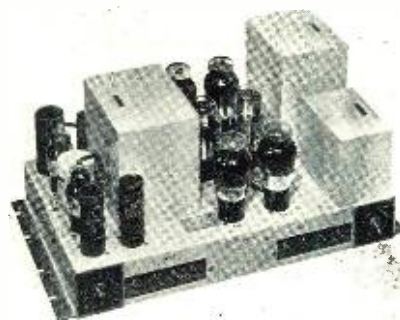

amplifiers. Where increased power is desired any number may be bridged across busses from 1 to 1000 ohms. Therefore, a complete amplification system of high quality and great flexibility is provided when used in conjunction with a program or line amplifier such as the Langevin 102 series.

All models in this 101 series will deliver 50 watts to a nominal load impedance with less than 3% r.m.s. harmonic distortion at 400 cycles. The gain control provides continuous adjustment over a 40-db. range and bridging connections. Chasses are 16-gauge welded steel, zinc plated, and bonderized. Finish is light gray baked enamel, and weight is approximately 45 pounds.

FUSE PANEL

With the increased demand for electrical fuse panels engineered to individual specifications, *Littelfuse, Inc.*,

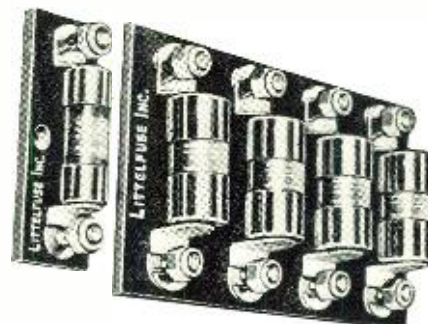

has announced a new improved Universal Fuse Panel, No. 1505.

Blueprints of this unit are now available to engineers, draftsmen, prime contractors, and purchasing agents upon request to their plant.

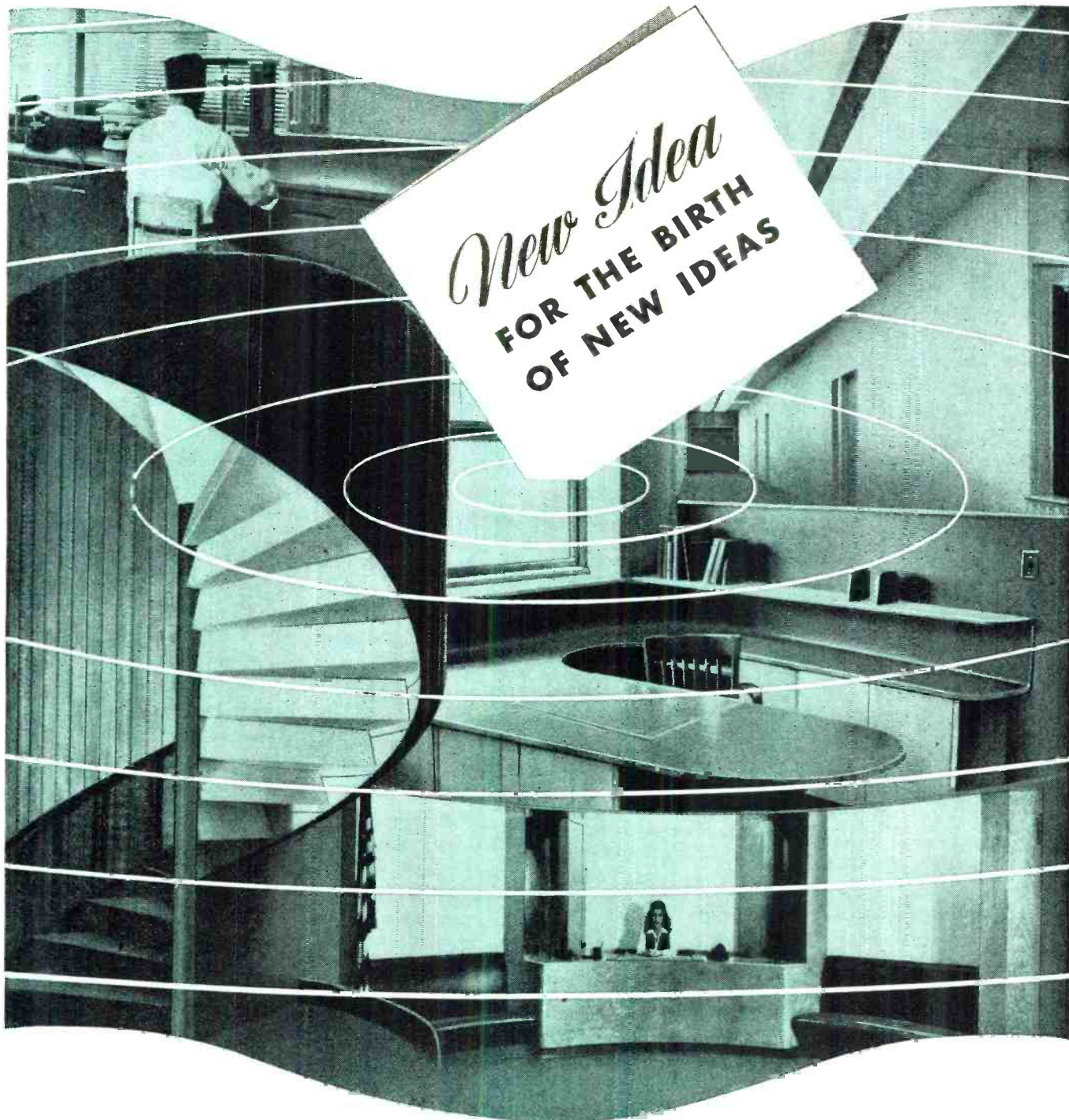

New Idea
**FOR THE BIRTH
 OF NEW IDEAS**

The entire Detrola Radio plant is a new idea in radio manufacturing technique. All of its departments—administrative, engineering, design, production—are spacious, orderly and modern . . . and modernly equipped. This not only promotes employee efficiency, but stimulates workers to conceive ideas for ever-greater improvement of both our products and manufacturing methods. Such conditions have enabled us to achieve high quality, high volume war production. They will likewise enable us to build highest quality radio receivers, automatic record changers, record players, radio television receivers and other electronic devices when our efforts are again happily directed toward those peacetime pursuits.

DETROLA RADIO
 DIVISION OF INTERNATIONAL DETROLA CORPORATION - HEADQUARTERS AT CHATELAIN, DETROIT 8, MICH.
 C. RUSSELL FELDMANN  PRESIDENT

BUY MORE WAR BONDS

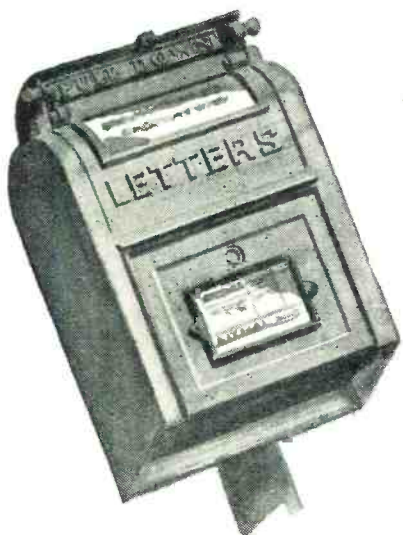

Your Post-War Job Security and Happiness Begin Here!

Prepare Now--With CREI Home-Study Training For a Better Job and Secure Career in **RADIO-ELECTRONICS**

Add CREI technical training to your present experience—then get that better radio job you want—make more money—enjoy security

CREI Practical home study training in Radio-Electronics Engineering equips you with the ability to go after—and get—a better-paying, secure radio job.

After the war will come the period of the "survival of the fittest." Employers can then once again be "choosy" in selecting the best-trained, best-equipped men for the best jobs.

In our proved course of home-study training, you learn not only *how* . . . but *why*! Easy-to-read-and-understand lessons are provided you well in advance, and each student has his personal instructor who corrects, criticizes and offers suggestions on each lesson examination. This is the successful CREI training that has trained more than 10,000 professional radiomen since 1927.

Your ability to solve tough problems on paper and then follow-up with the necessary mechanical operation, is a true indication that you have the *confidence* born of *knowledge* . . . confidence in your ability to get and *hold* an important job with a secure, promising post-war future. These jobs are waiting today for radiomen with up-to-date CREI technical training. Investigate CREI home-study training . . . and prepare now for security and happiness in the coming New World of Electronics! Write for all the facts now.



**WRITE FOR
FREE 36-PAGE
BOOKLET**

"Your Opportunity in the New World of Electronics"

TELL US ABOUT YOURSELF, so we can intelligently plan a course best suited for your needs. If you have had professional or amateur radio experience—let us prove to you we have something you need to qualify for a better radio job. To help us intelligently answer your inquiry—PLEASE STATE BRIEFLY YOUR BACKGROUND OF EXPERIENCE, EDUCATION AND PRESENT POSITION.

CAPITOL RADIO Engineering Institute

HOME STUDY COURSES IN PRACTICAL RADIO-ELECTRONICS
ENGINEERING FOR PROFESSIONAL SELF-IMPROVEMENT

Dept. RN-2, 3224—16th Street, N. W., Washington 10, D. C.

Contractors to U. S. Navy—U. S. Coast Guard—Canadian Broadcasting Corp.
Producers of Well-trained Technical Radiomen for Industry.

Special advantages are to be found in aviation applications of this unit where the fuse panel can be placed at an accessible point rather than in a central junction box. Dispersal of these panels throughout the plane lessens the likelihood of complete outage due to gunfire.

The light durable panels, made to individual specifications, meet all Air Corps requirements and come ready to mount, equipped with terminals and fuse clips or terminal studs.

Panel users are invited to write to *Littelfuse, Inc.*, 4757 Ravenswood Avenue, Chicago 40, Illinois, for copies of the blueprints.

HAND SEARCHLIGHT

A searchlight for use by maintenance groups and in industry is being offered by the *U-C Lite Manufacturing Company*.

This unit, the Big Beam No. 411, is completely portable and will project an intense beam of light more than 2500 feet, or provide diffused lighting by means of a snap-on lens.

The searchlight is powered by a heavy-duty, 6-volt storage battery which may be recharged from an a.c. charger, d.c. line or light plant. The lamp head can be turned in any di-



rection and stays adjusted. Other models are available powered by dry-cell batteries.

The *U-C Lite Manufacturing Co.*, 11 E. Hubbard St., Chicago, 11, Ill., will forward details upon request.

SOLDERLESS TERMINALS

A completely new solderless terminal is being offered by the *L. S. Brach Mfg. Corporation* who manufactures this unit under license from the *Buchanan Research Laboratories, Inc.*

The Bee Terminal Block is a connector strip with various numbers of terminal posts, each terminal capable of handling from two to eight wires. The binding post stud has a slotted channel, the wires being held in this channel between a top clamp or shoe built into the nut, and a lower clamp or shoe which is secured to the base. This arrangement permits every wire



WHY WE LIKE TO "ROLL OUR OWN"

THE production of high-efficiency electrical and electronic equipment demands close control over the manufacture of most of the parts which go into it.

To be certain of accurate control over component parts, Connecticut Telephone and Electric Division manufactures an unusually high percentage of them in its own plant. For instance, we produce our own magnets, wind our own coils. Stampings and screw

machine products are turned out to our own standards, in our own shops.

These facilities for complete fabrication of the more essential elements of a piece of electrical or electronic equipment are as important to our customers as to us—they result in a better product at a "better" price . . . also assurance of our ability to keep delivery promises.

MAGNETS have a great deal to do with the efficiency of many types of electrical apparatus. Specially developed alloys treated in our own electric furnaces permit close control over the performance of C. T. & E. products.



CONNECTICUT TELEPHONE & ELECTRIC DIVISION
GREAT AMERICAN INDUSTRIES, INC. • MERIDEN, CONN.

TELEPHONIC SYSTEMS • SIGNALLING EQUIPMENT • ELECTRONIC DEVICES • ELECTRICAL EQUIPMENT
HOSPITAL AND SCHOOL COMMUNICATIONS AND SIGNALLING SYSTEMS • IGNITION SYSTEMS

HARVEY

has for

Immediate Delivery

- American War Standard Meters in all different ranges — microammeters, milliammeters, ammeters, voltmeters, db. meters, portable instruments, etc.

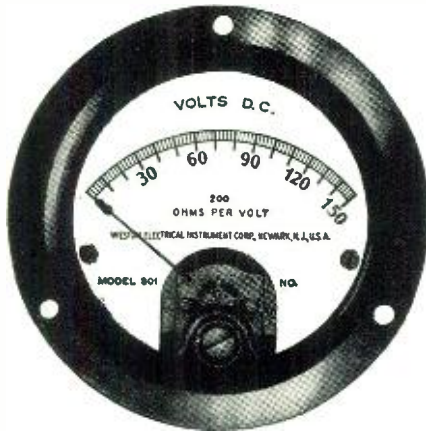

Illustrated is the Weston Model 301, just one example of the wide variety of famous make meters available at HARVEY'S.

- Mica Capacitors with 2%, 5%, 10%, or 20% tolerance to American War Standards. Also in stock are oil and electrolytic condensers.

- Precision carbon or wire wound resistors.
- 10 and 50-watt ceramic sockets.

... and hundreds of other critical radio and electronic components.

HARVEY is the complete radio and electronic supplier. Locating hard-to-find parts is but one of our many plus-services. We are prepared to answer your technical questions ... to advise you about priorities. Fast deliveries to any point in the United States.

Don't forget...

HARVEY also carries distinguished **AUDAK** equipment... cutters, jewel points, and pick-ups preferred by broadcasting stations and recording studios.



This merchandise available with suitable priority. Write, phone: LONgacre 3-1800

HARVEY
RADIO COMPANY
HARVEY
103 WEST 43rd ST., NEW YORK 18, N. Y.

to be locked to a wire, firmly in position, in a vibration proof and low resistance connection, without danger of loose strands. No lock nuts, lock washers, double nuts, lugs, or other accessories are necessary. This method obviates the necessity of soldering, crimping, pressing or insulating and requires no special tools.

This block is particularly recommended for aircraft, marine and communications applications. Samples and complete descriptive literature are available upon request to *L. S. Brach Mfg. Corp.*, Newark, 4, N. J.

CHASSIS CRADLES

A device for speeding the handling of chasses on the assembly line is being introduced by the *Acro Tool and Die Works*.

This unit holds the assembly in an easy-to-get-at position for quick inspection and repair. This allows the workers to use both hands and permits them to position working areas to their convenience. The assemblies can be rotated and locked in position easily and rapidly.

The chassis cradle reduces the danger of damaging tubes, coils and other delicate parts due to dropping or bumping of the chassis.

The unit is made of cadmium plated steel and white metal, consisting of the supporting legs and locking clamps. The unit adjusts to any position by

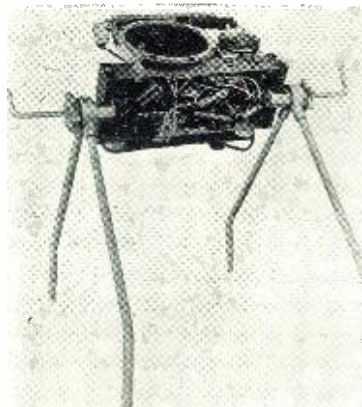

means of finger-tip control and is equipped with an automatic lock.

The manufacturers are prepared to ship immediately on all orders. Write to the *Acro Tool and Die Works*, 4892 N. Clark Street, Chicago 40, Illinois, for full particulars.

INDUCTION GENERATORS

A new drag cup induction generator is being introduced in the *Elinco* line according to a recent announcement.

This unit is available in both base and frame-mounted models and is housed in die-cast aluminum alloy treated according to Army and Navy specifications.

The generators consist of laminator stator wound two-phase, stationary steel pole, and aluminum cup on the shaft rotating between the stator and the pole. When the voltage is applied to one of the two stator phase terminals, rotation of the shaft and cup in-

duces a voltage at the other terminal producing a voltage which is lineal with the speed. The torque required for rotation is approximately 25 grains at 1" radius. For increased voltage,



where linearity is not required, a copper cup may be substituted for the aluminum.

This unit is available in several models to fit manufacturing requirements. Requests for additional information and engineering data will be handled promptly when addressed to *Electric Indicator Company*, Stamford, Conn.

FENCE CONTROLLER TUBES

Two new fence controller tubes are now being manufactured by *Taylor Tubes, Inc.*

The Taylor 208 is a glow discharge tube and the other, Taylor 207, is a rectifier. Both tubes have glass envelopes and a standard 4-pin base.

The electrical characteristics of the 208 include discharge at 875 to 950 volts d.c. at 8 milliamperes. The 207 has a filament voltage of 2.5 volts, a.c., filament current 2.5 amperes, with a maximum r.m.s. a.c. voltage of 1250, maximum d.c. current 125 ma.

Taylor Tubes, Inc., 2312 Wabansia Avenue, Chicago, Illinois, will supply additional information upon request.

COMBINATION TOOL

A new hand tool which combines all the steps involved in preparing a wire for a solderless terminal and in crimping the terminal to the wire has been announced by *Aircraft-Marine Products, Inc.*

In addition to the usual crimping notches, the 6-purpose tool includes an efficient wire cutter and an insulation stripper with the correct stripping length clearly indicated. Terminal stud hole sizes are also marked on the tool for quick checking.

Three types of terminals, for wire sizes 22 to 1C, can be crimped by this tool. The crimping notches are marked to correspond with terminals to be crimped and the stripping notches are marked with Navy Shipboard and Commercial AWG wire sizes.

The entire unit is compact and easily operated. Fully insulated handles are of molded plastic with the construction of heat-treated steel with a rust-resistant finish.

Further information is available from the *Aircraft-Marine Products, Inc.*, 1591 North Fourth Street, Harrisburg, Pa. Ask for Catalog No. 49111.



KEEP UP WITH RADIO TELEVISION and ALLIED ELECTRONICS

Get in on the new developments in the fast expanding Radio Industry. Take your place in the field of Television. Make more money as a Modern Service Expert. Own and operate Your Own Business. Learn the latest Trade Secrets and Short Cuts through

SHOP METHOD HOME TRAINING

Don't waste time! Radio, F.M., Video (television), and the whole field of Electronics is changing fast. New methods, new techniques, new equipment. Today you must solve NEW problems in servicing and repairing F.M. receivers. Tomorrow there will be thousands upon thousands of Television Receivers to handle. Right after the war science promises NEW Electronic devices for household, factory and business.

ALL THIS MEANS NEW OPPORTUNITY FOR YOU IF YOU ARE READY

The thing to do is to GET READY right now. Find out about the marvelous new method of preparation—SHOP METHOD HOME TRAINING. Fill out and send in the coupon now.

Keep in Step with Shop Progress

Here IS the truly modern system of training. It matches the RAPID PROGRESS CONSTANTLY BEING MADE in Radio, Television and Electronics. It is up to date in every way because it comes right from the busy radio training shops of National Schools where experiments and developments are being carried on—where discoveries are being made all the time.

It is based on real shop methods—on the handling of real shop jobs. Only National can offer you SHOP METHOD HOME TRAINING because only National has the big busy shops to develop this method.

And it is time tested too. National Schools has been training men for industry, for government,

for business for more than a third of a century. In essence you get at home—in your free time—the very same kind of instruction that has helped thousands upon thousands of ambitious men to more pay and greater opportunity—that has set thousands of men up in business with little or no capital. You owe it to yourself to read the book "Your Future in Radionics"—sent to you FREE if you fill out and mail the coupon.

Now, right now, is the time to grasp the opportunity of today—a successful career for tomorrow. Radio, television and the whole field of electronics invites you. The industry is crying for trained men everywhere. A rapidly expanding industry—probably the greatest in history—holds out the promise of a rich future—prosperous security.

All This Modern Electronic Equipment and More Comes to You as Part of Your National Course

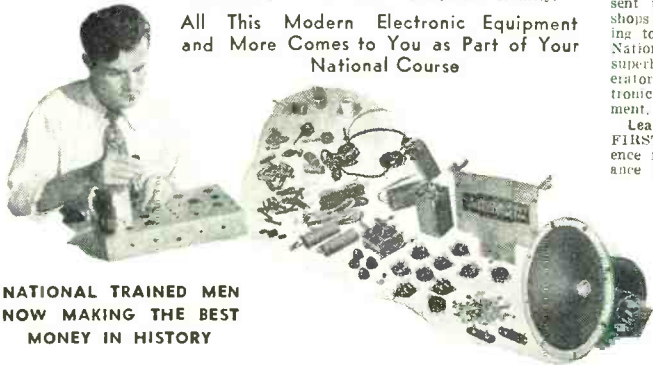

NATIONAL TRAINED MEN NOW MAKING THE BEST MONEY IN HISTORY

The real value of National training shows up in the quick progress our men make on the job. Joe Grumbich of Lake Hiawatha, N. J., turned down a job most men would welcome. He writes: "My latest offer was \$5,800.00 as radio photo engineer, but I am doing well where I am now engaged. I am deeply indebted to National."

Ely Bergman, now on Station WOR, told us: "My salary has been boosted considerably and at the present time I am making over \$3,000.00 per year, thanks to National Training." And from the far-off Hawaiian Islands, Wallace Choi sends this: "I am averaging \$325.00 a month. I will say that I honestly owe all this to the excellent training I had at National."

National is proud of the progress graduates are making all over the world. Read about their records yourself in the books we send you FREE.

Get This FREE LESSON

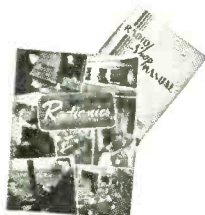

Get a FREE lesson from National. Study over your convenience. See for yourself how thorough, how sound and how practical—yet how amazingly easy it is to learn and understand. NO SALESMAN WILL CALL ON YOU FROM NATIONAL SCHOOLS. National points out the opportunity—offers you the training and experience, prepares you for greater things in life. But it is up to you to act for yourself. And the first step is to fill out the Coupon and mail it. Get FREE lesson, the big Radio Book, and then decide.

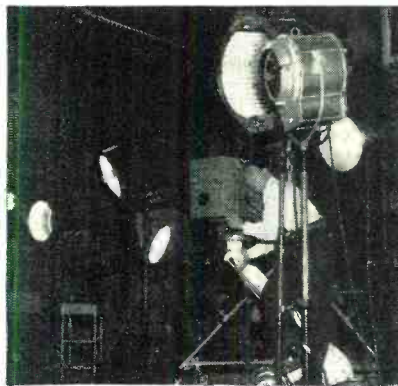

GET THE REAL EXPERIENCE BEFORE YOU TACKLE A JOB

Walk into a brand new job and go to work with assurance—the assurance that comes with knowing how—that comes with handling the tools—with working with and operating actual electronic equipment sent to you from the laboratories and shops of National Schools. There's nothing to equal learning by doing. In your National training you build real sets—a superheterodyne receiver, a signal generator—literally scores of various electronic devices with your National equipment.

Learn basic principles—FIRST THINGS FIRST. Get your knowledge and experience first hand under the personal guidance of seasoned, practical National instructors working personally with you. You know the very how and why of Radio—Television, Electronics.

Not only do you gain marvelous actual experience by this method of learning but you have valuable equipment you will use on the job in the practice of your profession as an electronics expert. Mail the coupon and learn what this means to you.

AFTER THE WAR WHAT?

Face realities now! Is the job you're doing going to last? What is its future and yours? How are you going to meet conditions when the world returns to civilian production? There's no use in fooling yourself. Radio is a BIG, SOUND, WELL ESTABLISHED BUSINESS.

There are millions of sets in the Country that need reconditioning right now. There is a big demand for millions more that have to be built—largely by trained men. F.M. is here to stay. BUT RADIO IS ONLY ONE FIELD OF ELECTRONICS. Television is sure to come. Sets must be built, installed, serviced and repaired. Who's going to do it? Make up your mind that you are—and at a great big profit—for years and years to come.

What about facsimile? And the great new field of industrial electronics? It is established—here to stay. IT NEEDS MEN—RIGHT NOW AND MORE MEN NEXT YEAR. NEXT MONTH, TOMORROW!

When you hang up your uniform—when your war job folds up, will you step out proudly into a new field—an essential established industry?—perhaps into a business of your own?

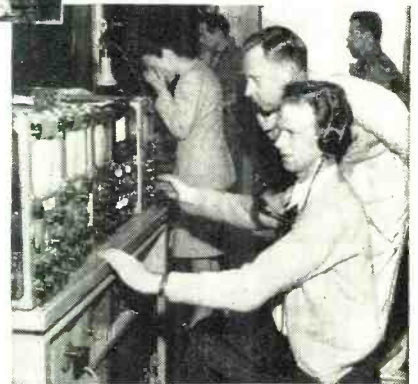

The above pictures were made in and around a modern television studio. Think what new opportunity is open to you in this great new field if you are ready for it. Prepare now. National training includes a good foundation in Television and F.M. Get the facts. Send the Coupon.

NATIONAL SCHOOLS

LOS ANGELES 37, CALIFORNIA EST. 1905



MAIL OPPORTUNITY COUPON FOR QUICK ACTION

National Schools, Dept. 2-RN
4000 South Figueroa Street, Los Angeles 37, California

(Mail in envelope or paste on penny post card)

Mail me FREE the two books mentioned in your ad including a sample lesson of your course. I understand no salesman will call on me.

NAME..... AGE.....

ADDRESS.....

CITY..... STATE.....

Include your zone number

FRENCH UNDERGROUND NETWORK during German occupation

By **KENNETH R. PORTER**

RADIO NEWS War Correspondent

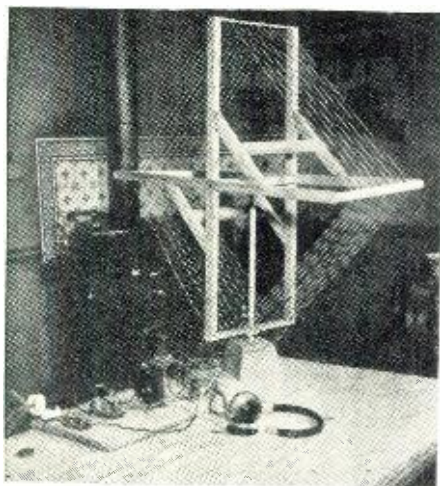

Crystal detector used by the French to obtain outside news during German occupation.

PRIOR to the Allied invasion of France, members of the Maquis (French Forces of the Interior) hiding in the rugged mountainous regions of Savoy, the Ardennes forest, or the barren heaths and marshes of the Landes, maintained almost uninterrupted communications with each other and the outside world by the aid of radio equipment either improvised on the spot or parachuted from Allied planes.

This radio equipment consisted mainly of short-wave transmitters which could be picked up over a radius of hundreds of miles on any ordinary broadcast receiver having provision for the reception of the higher frequencies.

In the spring of 1943, however, the German authorities in France clamped down on clandestine listening by con-

fiscating all radio sets they could lay their hands on.

The Maquis, in turn, extended the range of their transmissions to the lower frequencies and as the radiation strength of their transmitters was necessarily limited on medium and long waves to a few miles in radius, they gradually evolved an ingenious network of secret relay stations, linking virtually all centers of underground resistance in the country.

All these stations worked closely together and by transmitting messages containing warnings, instructions, or naming suspected agents-provocateurs

and collaborators from one end of the country to the other, played a most vital part in the struggle of the French underground movement against the German overlords.

The system of underground radio communications assumed such proportions, in fact, that a special control council had to be set up by the Maquis leaders for the allocation of call signs, frequencies, and assignments to these stations in order to avoid confusion.

Thus, some of the clandestine stations were detailed to maintain close liaison with Gen. de Gaulle's Fighting French Headquarters in London. Others, like "La France Resistante," given the mission of transmitting the communiques of Maquis exploits or like "La Voix de la Liberation," assigned the debunking of the histrionics emanating directly from Radio Vichy.

SCR-299 mobile communication transmitter specially adapted for the transmission of messages to the French Underground during initial invasion.

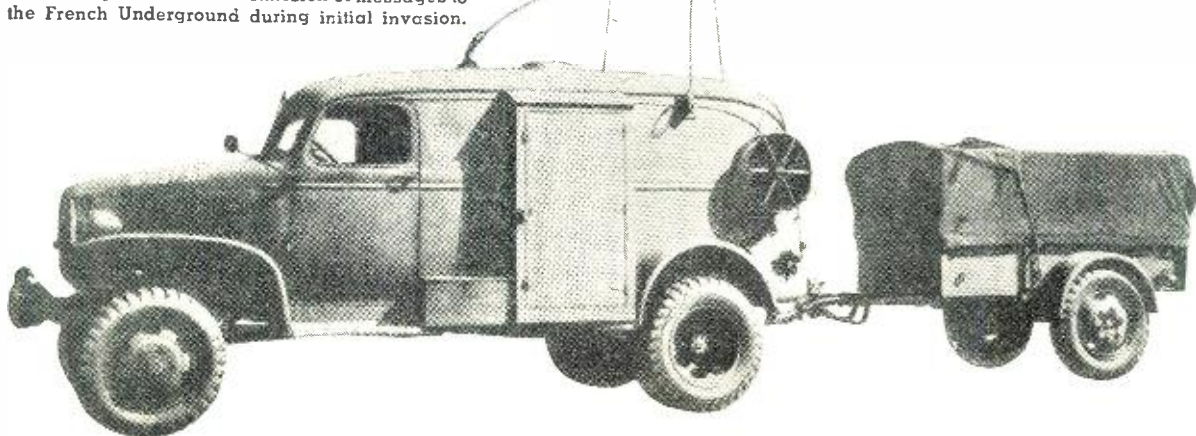

**The Best
Show
On the Air
Saturday
Night!**

"MEET YOUR NAVY"
Now Carries the RAYTHEON Name
into 3,500,000 Radio Homes Each Week!

Free!

Ask your Raytheon distributor
for colorful, attention-getting
"Meet Your Navy" display to
tie in with this great program.
Easel-mounted, 17 1/2 x 20 1/2".

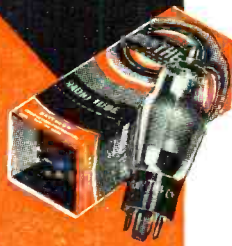

Every Saturday Night

ENTIRE BLUE NETWORK

Coast to Coast 181 Stations



RAYTHEON MANUFACTURING COMPANY

Waltham and Newton, Massachusetts



All Four Raytheon Divisions
Have Been Awarded Army-
Navy "E" with Two Stars

RAYTHEON

High Fidelity



ELECTRONIC AND RADIO TUBES

DEVOTED TO RESEARCH AND THE MANUFACTURE OF TUBES AND EQUIPMENT FOR THE NEW ERA OF ELECTRONICS

HURRY!
THEY'RE GOING FAST



CONCORD
RADIO CORPORATION'S
New
"SPECIAL SUPPLEMENT"
HARD-TO-FIND
RADIO AND ELECTRONIC
COMPONENTS

16 PAGES CROWDED WITH LISTINGS AND DESCRIPTIONS OF SUCH WARTIME ESSENTIALS AS...

- METERS
- VOLUME CONTROLS
- RHEOSTATS
- RESISTORS
- TEST ACCESSORIES
- SPEAKERS
- SWITCHES
- TRANSFORMERS
- RELAYS

...and hundreds of others!

Each page overflows with critical parts and equipment . . . urgently needed by industry, laboratories, government agencies, training schools, radio servicemen, military services, etc. Everything is the product of a leading American manufacturer. All are first quality. And all are marked at prices typical of startling Concord values! Hurry! Our edition of these supplements is moving fast. And, since all items are subject to prior sale, we suggest that you wait no longer. Send for your FREE copy today!

Rush this coupon
... and we, in turn,
will get the new 16-
page Supplement to
you by the fastest
possible means.

CONCORD RADIO CORPORATION
901 W. Jackson Blvd., Chicago 7, Ill., Dept. E-25

Please rush me the new 16-page "Special Supplement" just published by the Concord Radio Corporation.

NAME

ADDRESS

CITY..... STATE.....

CONCORD RADIO CORPORATION

Lafayette Radio Corporation

265 Peachtree Street
ATLANTA 3, GA.

901 W. Jackson Blvd.
CHICAGO 7, ILL.

This underground radio traffic went on continuously and almost openly despite frantic efforts on the part of Gestapo agents, provocateurs and quislings to track down the stations and their operators.

The civilian population of France, deprived in most parts of the country of their broadcast receivers by order of General Stuelpnaegel, the German C.-in-C., nevertheless contrived to keep themselves informed about what was happening inside and outside their country by listening to Maquis transmissions (and BBC transmissions) on valveless little detectors of the "Cat's Whisker" type.

In fact, a spokesman of the FFI categorically stated after liberation that these crude, homemade almost without exception, sets which in peacetime used to be the pastime of children, had been the main source of news and information of millions of Frenchmen. They had fostered and sustained effectively the morale of the people of France in the darkest hours of her humiliation under the iron-fisted rule of the German conquerors.

The crystal detector shown in the photograph perched on a mat-covered wooden table was encountered by the author in the kitchen of a stone cottage somewhere on the outskirts of a hamlet not far from Paris. It illustrates strikingly the skill and ingenuity with which simple, freedom-loving Frenchmen risking imprisonment and worse, outwitted the Germans, and is typical of the many to be found nowadays in the humble dwellings of the poor as well as in the magnificent chateaux of the wealthy.

This particular unit had been built by an unassuming little Frenchman, an active member of the FFI, whom it will be best to call Monsieur Francois (because his two sons are prisoners of war in Germany), after his multitube receiver had been carted off by the S.A. to a central depot for storage early in 1943.

Monsieur Francois said that he had not mourned its loss for long but set to work as soon as possible on the construction of a crystal detector with the aid of the specifications which in those days used to be broadcast at regular intervals by the famous Col. Britten and his associates of the French section of the BBC in London.

With a volubility with which it was most difficult to keep track, Monsieur Francois then proceeded to describe how he had managed to procure a pair of high-resistance headphones smuggled out of the German supply stores by a French worker of his acquaintance and find a variable condenser by overpaying its market value many times, coupled with the employment of sundry ruses and palavers.

Insulated copper wire for the tuning coil, Francois obtained by dismantling the bobbin of a disused electric bell and a postal tube on which to wind the wire from a cardboard shoe box.

By various dubious means he even

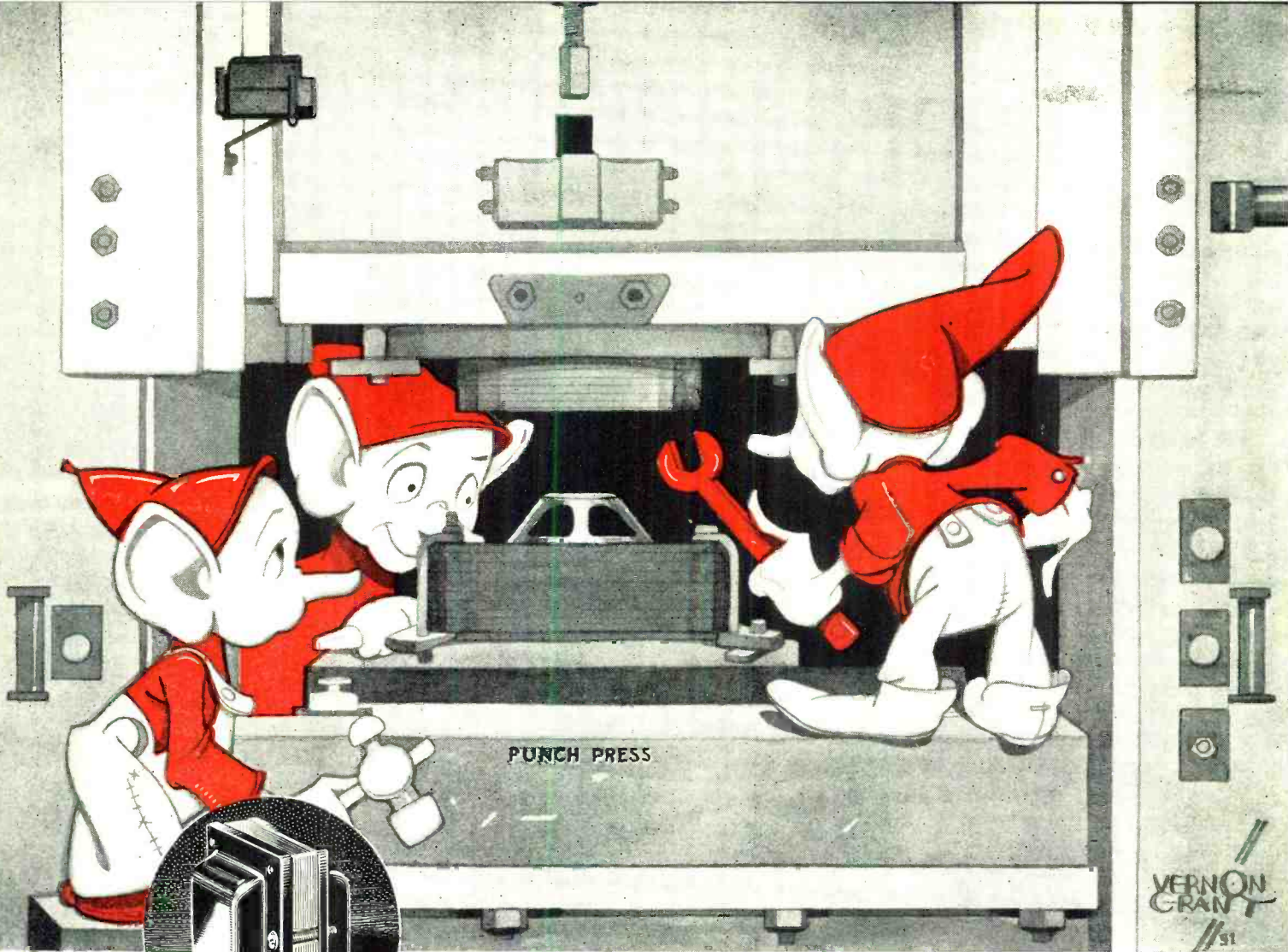

This speaks for itself: Utah is its own transformer supplier for speakers, vibrators, wire recorders, etcetera.

UTAH'S COMPREHENSIVE PROCESS ... GUARANTEES PERFORMANCE!

Sure, this is a punch press . . . and Utalins* know that a punch press is a pretty important piece of equipment in Utah's modern plant. They guide it in an important step in the precision manufacture of Utah's products and see 'way beyond . . . to the finished products in action.

The honest pride they feel in their part is the knowledge that Utah's process makes superior quality inevitable . . . eliminates the possibility of error. Utah's plant is entirely self-contained. Every phase of manufacture, from buying raw materials to final delivery of inspection-tested pieces is under Utah's own exacting supervision. Constantly, painstakingly, Utah controls, inspects,

rejects and supervises every step of the way.

Yes, heavy machines are made to produce with the precision of delicate instruments in Utah's comprehensively controlled process. And the result is Utah performance . . . accepted internationally as the absolute standard of quality.

*Utah Radio Products Co., 820 Orleans St., Chicago 10, Ill.
Utah Products (Canada) Ltd., 300 Chamby Rd., Longueuil, Montreal (23) P. Q.*



*Utalins— Utah's helpers



We're Looking
"WAY AHEAD"

Yes, we're not only looking ahead to a great expansion in transformer needs, but we're accumulating advanced ideas from our war work which will be built into transformers, for many purposes, when commercial requirements return . . . Keep "Stancor" in mind—for improved design technique and exclusive technical developments in transformers.

STANDARD TRANSFORMER
CORPORATION

1500 N. HALSTED STREET • CHICAGO 22, ILLINOIS



managed to secure a readymade crystal but only to discover that in spite of its blood red color and the trademark "Zincite" stamped upon the mounting proclaiming this crystal to belong to the zinc-oxide variety, it failed to give satisfactory reception.

Undaunted by this misfortune, the Frenchman continued his search and tipped off by another of his (numerous) friends, contrived somehow to get hold of a small fragment of coal showing yellow specks as evidence of containing crystals of copper pyrites. He mounted this into an empty cartridge case (later to be substituted by an ordinary piece of brass tubing of small diameter when this method of mounting proved rather cumbersome). A gramophone needle wound with the copper wire in spirals was used as the "cat's whisker" for making contact with the nutmeg of coal.

As no outdoor aerial customary for this type of receiver could be employed without courting disaster, Monsieur Francois stretched some lengths of copper wire inside the loft of his cottage from end to end with all the wires connected together at one end and joined to the aerial terminal of the set; a piece of wire bound tightly round the main water pipe (scrap cleaned with a knife) being used as a ground, completed the arrangement.

But Monsieur Francois' troubles were by no means over!

The sensitivity of the set was far from satisfactory and its selectivity deficient.

French ingenuity, however, improved station reception by the aid of an extemporized revolving loop aerial (depicted on the photographs). This eliminated adjacent and second channel interference as well as German jamming by the simple expedient of using a wave trap.

When in the end all difficulties had been overcome and the detector had passed, through the enterprise and perseverance of its owner-maker, all the vicissitudes to which these instruments appear to have been subject in occupied France could be put into operation, and the reception of Maquis and BBC transmissions on medium and long waves was excellent.

After Monsieur Francois had concluded his description of how he had built his receiver, he told me with a humorous twinkle in his eyes that actually he had gained by the exchange of the multitube model for the present one as his dependency on the electricity supply had ceased forthwith and with it the annoying practice of being cut off in the middle of important transmissions.

"Moreover," he added, "the crystal detector could be set up and dismantled in a matter of seconds without leaving a trace and it used to be great fun watching baffled German patrols searching all over the place for it in vain."

A new chapter was added to the history of French underground radio traffic at the time of the invasion when

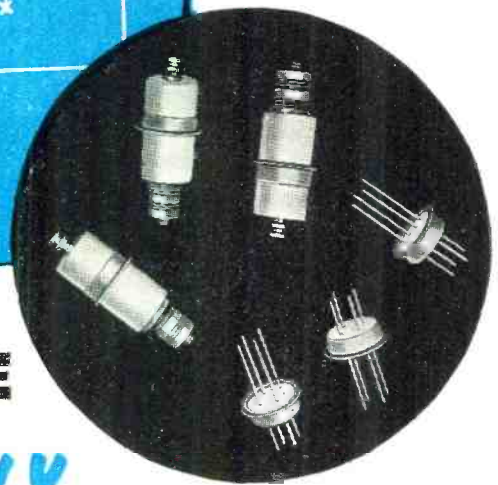
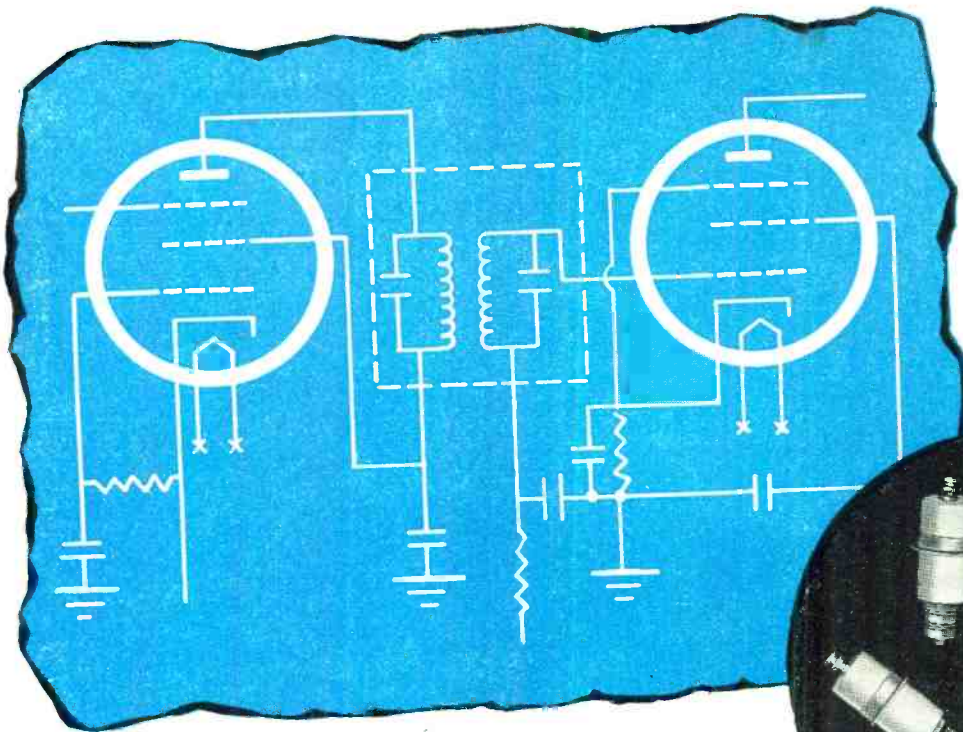

STEEL and STEATITE **bonded *PERMANENTLY***

The high mechanical strength of steel and the excellent, permanent insulation qualities of STEATITE have been combined by General Ceramics through its development of a new method of hermetically sealing and permanently bonding together STEATITE and metals in various combinations.

These SEALEX combinations successfully withstand the most severe temperature changes, and show no vibration fatigue. The metal parts are tinned to facilitate soldering where desired.

The General Ceramics method of fusing steatite and steel solves the problems of hermetically sealing and permanently protecting equipment against moisture.

For long-life, dependable, efficient service specify "Steatite" and "Sealex" Combinations.



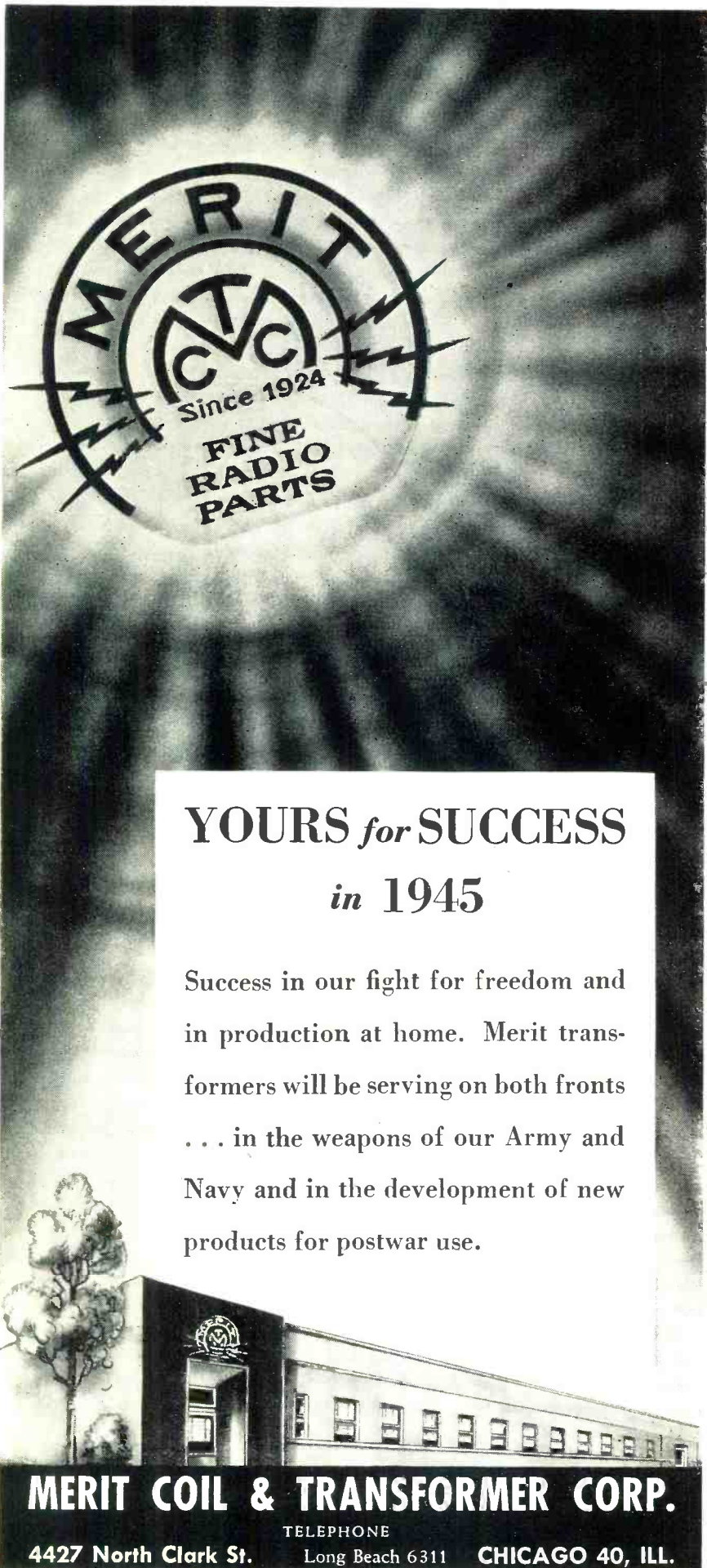

YOURS *for* SUCCESS in 1945

Success in our fight for freedom and in production at home. Merit transformers will be serving on both fronts . . . in the weapons of our Army and Navy and in the development of new products for postwar use.

MERIT COIL & TRANSFORMER CORP.

TELEPHONE

4427 North Clark St.

Long Beach 6311

CHICAGO 40, ILL.

Allied officers of the Psychological Warfare Branch following in the wake of the amphibious landing troops established direct radio contact with the Maquis groups operating in the invaded areas.

Six mobile communication transmitters were landed and put into operation on D-day plus six facilitating the carrying out of an important phase of the general tactical invasion scheme.

These transmitters were Hallicrafter SCR-299's which had been adapted specially for the purpose of transmitting signals on the standard broadcasting band (550-1600 kc.) in addition to their regularly assigned higher frequencies by U.S. Signal Corps engineers under the command of Major-General W. S. Rumbough, Chief Signal Officer, ETOUSA.

Members of the FFI received instructions sent out through these transmitters within a radius of many miles by day and night despite the limitations imposed on radiation by combat conditions. Acting upon these they promptly went over to the offensive and began such work specifically assigned to them by the Allied command operations as the blowing up of railway bridges, marshalling yards and ammunition dumps in the German rear, the derailment of trainloads of enemy soldiers and supplies bound for the invasion beaches and the cutting off from base of their isolated garrisons.

In addition, SCR-299 transmitters also were employed for a variety of miscellaneous purposes and used as impromptu broadcasting stations on frequencies occupied by regular French stations put out of action by the retreating Germans (as in Cherbourg), for relaying BBC and ABSIE (American Broadcasting Station in Europe) programs in combat areas. They were used as well for the dissemination of news and announcements over p.a. systems on the so-called "Milk Routes."

One SCR-299 transmitter has been credited even with persuading a German garrison at an unidentified submarine base to surrender unconditionally!

-30-

OVERCOMING PRECIPITATION STATIC

SIGNAL experts have discovered a way to overcome precipitation static, it has been disclosed by the Air Service Command in Britain.

Baffled for many months by radio noises resulting from the build-up of static electricity in the aerials and skin of aircraft, Air Service Command technicians solved the problem by the simple addition of a resistor across the antenna circuit of the receiver, which drained excess static electric charges before they could discharge and cause interference in the radio sets. This method has been adopted throughout the Air Forces.

-30-

SPRAGUE TRADING POST

A FREE Buy-Exchange-Sell Service for Radio Men



You Can Get Koolohms Now!

At last, greatly expanded production is beginning to match even the tremendous war equipment demand for Sprague *KOOLOHM Resistors. As a result, we have been delivering good quantities of 5- and 10-watt sizes in all ranges to Sprague distributors—and hope soon to make a similar announcement, both with regard to KOOLOHMS in other sizes and to many of the previously unavailable Sprague Capacitor types.

As always, we'll appreciate it if you ask for them by name!

TEST EQPT. NEEDED—Pfeiffer Hickok RP04 Oscillograph; PSG-15 Microvolter six gen.; T53 or 51X tube tester; Model 48008 zero current voltmeter or #5348 tube tester and zero current set analyzer; also 4758 appliance tester. Any good late model eqpt. bought. Sumner Radio & Motor Service, 6709 N. E. Sumner St., Portland 15, Oregon.

FOR SALE OR TRADE—Carter 6v-400v, 250 MA Generator; Pioneer 6v-300v MA Generator; Dupont 164 Oscilloscope; 4 Jensen 1M12C speakers in parabolic baffles. **WANT:** Audio oscillator, Supreme 582-A Signal Generator, Henry's Radio, 410 Thames St., Newport, R. I.

WANTED FOR CASH—Discharged veteran needs signal generator; V.O.M.; tube tester; Rider's canalyst; voltohmmyst, etc. Also 1.4v, 6v, 12v, 35v, 50v, 117v series tubes, any quantity. Ben A. Guzzardo, S.O.S. Radio Service, Stratton-Stricker Bldg., Waco, Texas.

FOR SALE—RCA AC-DC modulated phonograph oscillator with RCA 12A7 tube; Hoyt 300 DC voltmeter range, 0-30-300-v; Readrite 55 AC voltmeter range, 0-10-140-v; Readrite #55 milliammeter range 0-15-150 MA; 3 filament transformer, 6.3-v; power transformer; 2½-v filament, 5-v filament, 250-v high voltage secondary; Filter Choke, 200 ohms resistance; Stancor 15 henry filter choke, 40 MA; Stancor heavy filter choke, 150 MA; RCA multirange wave trap; Astatic 5-M scratch filter, bi-polar 6 position tap switch; two 2-circuit, 5-tap switches; Super Akra 100,000 ohm wire-wound resistors, also 300,000 ohm; Philmore Dynamic, O. F. Sterneman, Box 3260, Honolulu, T. H.

WANTED—F-M tuner for high-frequency police bands, 30 MC of 116-120 m.c. Al. Birch, Box 13, Parkland, Wash.

FOR SALE—Supreme 370 signal generator, six tube series; 125 K.C. to 60 M.C. Hart 400 cycle audio output; frequency input jacks; external modulation jack. Factory reconditioned, accurately calibrated. Martin Radio Service, 142 Ralph Avenue, Brooklyn 33, N. Y.

FOR SALE OR TRADE—For test equipment, such as signal generator, or what have you, 6-tube superheterodyne without cabinet, 10-inch Rola speaker? Henry C. M. Bursun, 1-984 E. 70th St., Cleveland, Ohio.

DISPOSAL SALE—Short wave receiver parts; 00014 Var. condensers; resistance coils; Thordarson, Maxium and Karas power audio, straight or push-pull trans. Cannonball head phones; 6" & 9" loud speakers; sockets; panel mount meters and many other parts, brand new, in original wrappers, at one-half cost. P. E. Chapman, 5029 Osage Ave., Philadelphia 43, Pa.

FOR SALE—Small lot of tubes in sealed cartons OPA list. (Whole group only.) 185, 1LN5, 1L115, 12J5, 12SK7, 25L6, 80, Success Radio Service, 122 Motor Ave., Salt Lake City, Utah.

WANTED—Test and service equipment of all kinds—at once—with instructions on how to use. William J. Croft, R. D. No. 5, Bedford, Va.

WANTED—Hallcrafters Sky Champion model S-20-R, C. E. Riley, 32 Davis Ave., Cranston 10, R. I.

WANTED FOR CASH—3-inch Dumont or Supreme scope. Also good SX28 receiver. Woodrow F. Wroslon, Hotel Yankee, Grand Island, Neb.

FOR SALE—Factory reconditioned Astatic mike T3 with floor stand, \$25; Astatic mike D2, \$15; power shifter from 6v battery to 1.4v, 300 m.a. B90V 10 m.a., \$12.50; and new radio tubes at 40% off list, including 6V6GT, 6Z7G, 6SN7GT, 6L6G, 125G, 6S7GT, 34, 46, 12J5GT, 12A5, etc. Doerr Radio Service, 1165 Bredlove, Memphis, Tenn.

WANTED—Superior set tester analyzer. Hilinski Radio Service, 51 Leonard St., Buffalo 12, N. Y.

FOR SALE—Tubes, at O.P.A. list price. Willie K. Patterson, 636 Chipley Ave., Greenwood, S. C.

WANTED—Readrite meters of all types. Daye Mate, 1122 College Ave., Alameda, Calif.

WANTED—Test equipment for radio servicing—also tubes. What have you? Philips, 1410 N.W. 26th St., Oklahoma City, Okla.

FOR SALE—RCA 150 oscillator and 151 scope; Instructograph, Jr.; Rider's 3, 4, 5, 6, 7, 8 and 9; Radio News June '36 to date; QST, January '39 to December '41; Centralab standard controls; Centralab switches; heavy duty mike stand; and wood lathe. Howard Abeinathy, Batavia, Iowa.

FOR SALE OR TRADE—Two 955's and 2-185's both with sockets. Want 1" scope, 666GT tubes; also issues QST and Electronics magazines. Art Kirchoff, 209 Brackenridge St., Ft. Wayne, Indiana.

FOR SALE OR TRADE—Meissner 12-tube, 5-band (long and shortwave), \$95, urgently need Jensen bass reflex speaker enclosure (12") No. CA-12 or BR-121; good signal tracer with V.T.V.M.; Hallcrafters SGT2R or S-20; Echophone EC-1, 2, 3, or 4; oscillograph, Mike Blackwell, 360 West California Ave., Memphis 5, Tenn.

FOR SALE—Scarce tubes such as 12SA7, 12SK7, 35L6, 35Z5, 6F6, 1N5, 1H5, new and used. Want Webber oscillator, 8 mm. movie projector and camera, N. C. 44, 45 or similar receiver, and vibrator unit. J. M. Fraser, Box 95, Binscarth, Man., Canada.

URGENTLY NEEDED—Tube tester, preferably American, Precision or Radio City. Will accept combinations. Dorsey H. Corun, P. O. Box 173, Braddock Heights, Md.

FOR SALE—Universal Weston Master Exposure Meter and leather case, A-1 shape. \$23 cash or trade for equal amount in the following tubes: 1A7GT, 117L7, 117T7, 50L6, 35L6, 12SA7 and 12K7GT. Radio Engineering Service, 2859 Valentine Ave., Bronx 58, N. Y. C.

FOR SALE—Power transformers for Radiola and G.E., audios for Radiola and Acme, Ill. X-former, speakers with outputs, variable condensers, etc. Frederic R. Crownfield, Jr., 29 Reed St., Abington, Mass.

WANTED—AC voltmeter, tubes and six generator. T. Pruitt, 2512 Gray Manor Terrace, Dundalk 22, Md.

FOR SALE—Test instruments, supplies and tubes, including 6SA7, 6SK7, 80, 12SK7, 128Q7, etc. John Trowbridge, Dept. SP., 7936 Farnell, Chicago 20, Ill.

FOR SALE—5 output transformers and 155 new radio tubes, including 1LN4, 6J5, 6X5, 6AR, 6SA7, 6SK7, 78, 25L6, 80, 1R5, 184, 1T4, 3N4, 6L6, 3Q5, 35Z3, 7A7, 7HT, etc. United Radio Service, Box 194, Centreville, Miss.

URGENTLY NEEDED—Phono-recorder complete with radio tuner—must be A-1. Frank Andrich, Jr., 403 E. 16th, Vancouver, Wash.

FOR SALE—Used radio supplies. Write for list. J. C. Thimijan, 715 N. 7th St., Lake City, Minn.

FOR SALE—One each of the following tubes (in lot only): 1A4, 1C5, 1E7G, 1L14, 1N6G, 3Q5, 5V4, 6A6, 6ANM, 6I4G, 6C5, 6K7M, 6N7, 6R7M, 6SA7, 6SK7, 6V6, etc. Goodwin Radio Shop, Rankin, Ill.

WANTED—Analyzer and condenser tester. Will pay cash, or cash and following: Delco ¼ h.p. motor; 1C5, 1H5G, 6SA7, 71A, 80 (2), 27 (2) tubes; 5" p.m. dynamic speaker; radio texts. C. A. Williams, Morris, Ill.

URGENTLY NEEDED—A-1 pocket type multimeter or small test meters—Readrite 3-meter tester or equivalent. Fred C. Oldenburg, 1242 Roslyn Road, Grosse Pointe Woods 30, Mich.

FOR SALE OR TRADE—2-468 kc Xstals with holders, 2-F. E. cells and many other parts. What have you and what do you want? Urgently need instruction sheets or data (will buy or rent) concerning Superior V.T.V.M. #1260. Anthony Pusateri, 1101 Fleming St., Coacopolis, Pa.

WANTED—Filament transformer and instructions for Preceptor tube tester K. Will buy for cash or trade tubes, power trans., phono amp., etc. Stanley J. Zuchora, 2748 Meade St., Detroit 12, Mich.

FOR SALE—6-12SF5, 5-12J5GT, 7-6U5 tubes (all new), and 1 Elmac 250th (used). L. B. Cox, Box 447, Shelley, Idaho.

WANTED—35A5 tube and good volltommeter. Can also use all types 50, 35 and 12 v. tubes. Hank's Radio Service, Box 13, Easton, Minn.

FOR SALE—Philco #37-38 6 tube battery receiver, one short wave band; Philco #16 11-tube all wave receiver; and several B11 and 01A tubes. Harold W. Bower, 835 Susquehanna Ave., Sunbury, Pa.

WILL EXCHANGE—Simplex tube tester, 3 battery sets (good for parts), old table speaker and Flewelling tube checker for what have you? Norton Salk, 78 Homer St., Providence 5, R. I.

WANTED—Professional dual speed Presto recorder. Roger R. Warren, 213 N. Aurora St., Ithaca, N. Y.

WILL TRADE—Simpson O-5 mil milliammeter, 2½" dia., and a quantity of 6L6G, 6N7, 6SK7, and 6C5 tubes; also other tubes suitable for P.A. work. Want an all-wave sig. generator. Joseph Swartz, 231 Vaughan Rd., Apt. C-11, Toronto, Ont., Canada.

YOUR OWN AD RUN FREE!

This is Sprague's special wartime advertising service to help radio men get needed parts and equipment, or dispose of radio materials they do not need. Send your ad today. Write **PLAINLY OR PRINT**—hold it to 40 words or less.

Different Trading Post ads appear monthly in Radio & Television Retailing, Radio Service-Dealer, Service, Radio News, and Radio Craft. Sprague reserves the right to reject ads which do not fit in with the spirit of this service.

When buying Capacitors—please ask for Sprague's by name. We'll appreciate it!
HARRY KALKER, Sales Manager

SPRAGUE PRODUCTS CO., DEPT. RN-25, North Adams, Mass.

(Jobbing distributing organization of products manufactured by SPRAGUE ELECTRIC COMPANY)



SPRAGUE CONDENSERS KOOLOHM RESISTORS

TM, REGISTERED U. S. PATENT OFFICE

Obviously, Sprague cannot assume any responsibility, or guarantee goods, services, etc., which might be exchanged through the above advertisements

Flight Recorder

(Continued from page 27)

diameter of about $\frac{1}{4}$ ". Three iron washers are used for the side walls of the coils, and an iron sleeve, slotted for the passage of the wires, is slipped over the assembly. Thus each coil has a complete iron path for its field, except for the section through the core. Into the core is fitted an aluminum plunger, on which there is a small iron ring. The ring serves to increase and decrease the inductance of the two coils, providing a bridge balance in conformity with its position. Ranges of operation are adjusted by means of resistances which shunt the coils—much the same as in the case of the potentiometer. The coils generally have an inductance approximately four millihenries each. The plunger can be operated by various types of moving mechanisms located in the plane during a test flight, such as airspeed and altitude diaphragms or Bourdon tubes.

The instruments are scanned in rotation by a sequence switch, Western Electric Type RA 120K, which switches two points to 80 positions in single controllable steps, or in continuous rotation at a variable rate of about one revolution (80 instruments) per second. As each instrument is connected through the switch, it is compared with two permanent "legs" of the bridge, which are precision set to within .01%. The bridges are energized by a stabilized 1000-cycle oscillator, which delivers three volts

across a 20-ohm bridge; then the "off-balance" signal from the instrument is amplified, rectified, filtered, and used to control the frequency of an 884-type relaxation oscillator. This oscillator is set to deliver 1000 cycles at "zero balance" (i.e., with no voltage from the rectifier), and 3000 cycles at maximum "off balance" of the instrument; it is continuously variable between the two limits.

From the oscillator, the signal is fed to a "limiter" type amplifier tube, which holds all frequencies to the same output level and modulates the transmitter to full modulation. Because they are direct generators, tachometers are fed into the system in a different way; each generates a signal whose frequency is adjusted by means of the number of poles on the armature, and this signal is fed into an amplifier tube which replaces the above-mentioned limiter amplifier by means of relay switches; thereafter, the signal modulates the transmitter in lieu of the converter signal.

How is synchronization produced and maintained? One point of the sequence switch is used to insert an identification signal of 400 cycles, the signal being generated by a second 884-type relaxation oscillator. At whatever point it is to be inserted into the sequence, the switch shorts the converter signal to ground, and introduces the 400-cycle signal into the transmitter through the tachometer amplifier. (The transmitter employed is a frequency-modulated Link Type 35-UFM, operating at about 33 megacycles and delivering approximately 35 watts to the antenna.)

Perhaps the most important part of the flight recorder ground equipment is a Link receiver, matched by crystal control to the transmitter frequency and delivering two watts of audio power through a 500-ohm line to the recording equipment. This input may be divided into the following three ways:

1. First, to a pair of 884-type relaxation oscillators, operating as a limiter. Limiter output is fed to a discriminator-rectifier which changes the signal frequency to a direct-current electromotive force which is proportional to the input frequency. This direct current is impressed upon a condenser and later matched against a varying direct-current voltage by means of a comparison method.

2. Second section of the input is amplified and fed through a 400-cycle filter into a switch, which contacts each of 80 neon lights in succession. The lights are used in banks of 10, which are switched manually from 0 to 80. Thus, when the manual switch is on No. 20, the lights indicate 20-29, inclusive. When the 400-cycle impulse is fed into the plane's transmitter, the consequent signal will light the neon bulb contacted by the ground switch at that time. The 400-cycle filter automatically eliminates all other frequencies.

3. We can best understand the third division of the signal by examining the nature of the signal fed into the transmitter which is located in the plane.

As it rotates, the sequence switch swings each instrument into place in succession; and each instrument

This drawing details the aircraft portion of the new flight recorder as it might be installed in a Liberator B-24J Bomber. Although this equipment may appear to be rather extensive, it has a gross weight of only 55 lbs. and occupies a maximum area of only 4 cubic feet.

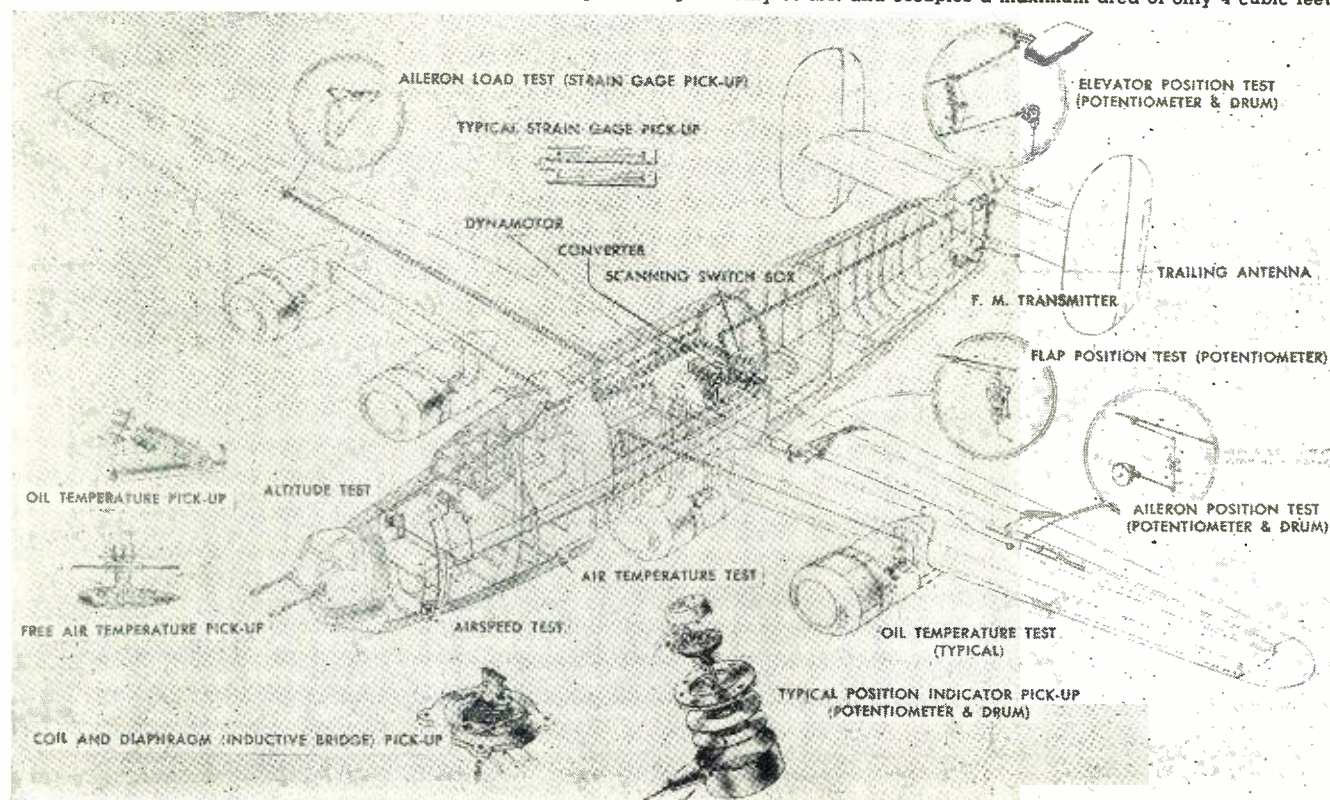

RCA's New 170-A Audio Chanalyst

Tests Everything
from Microphones
to Multiple Speakers

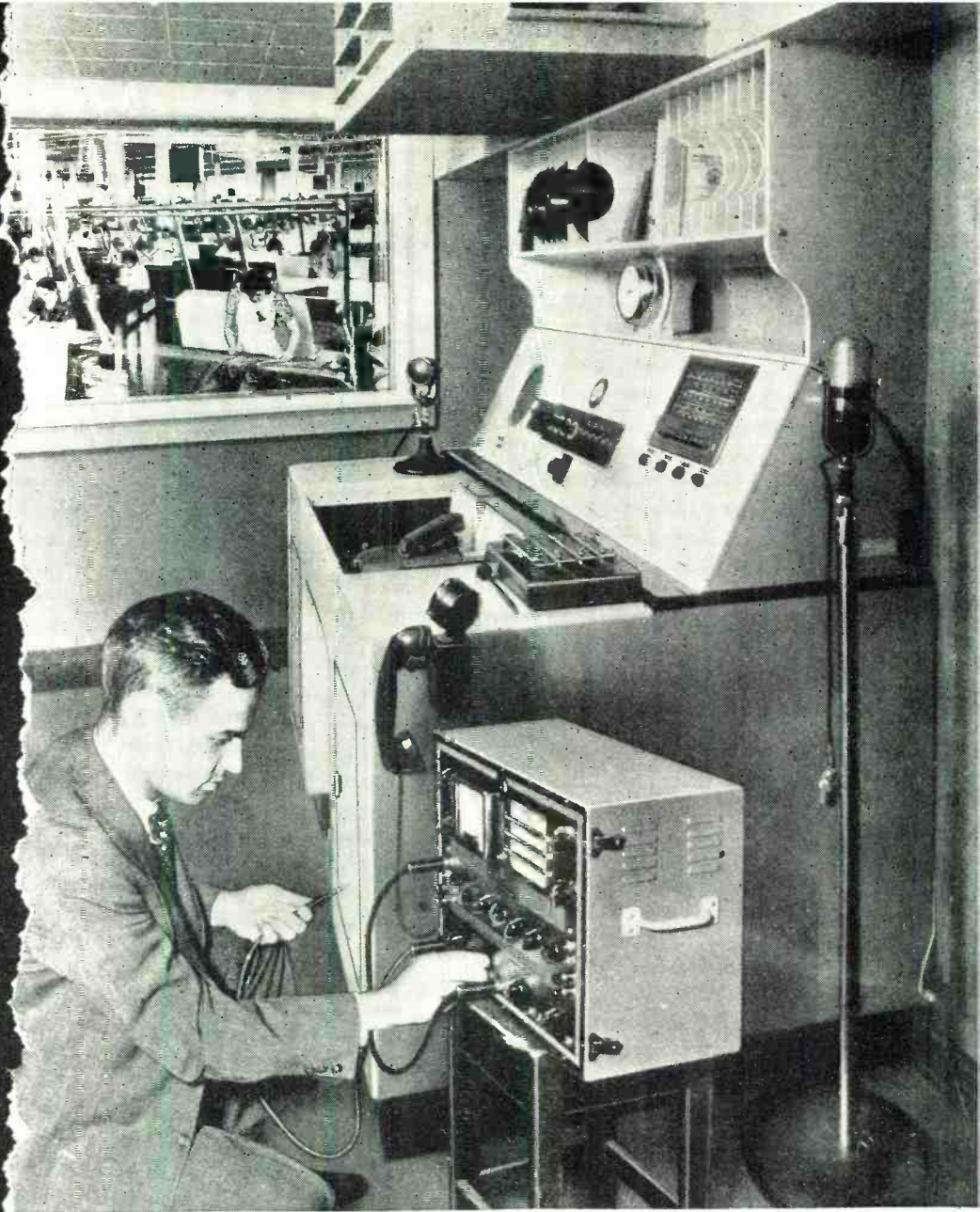
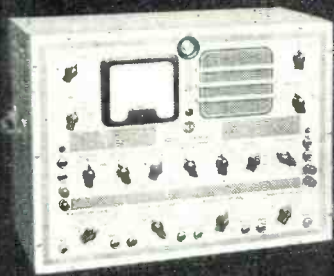

THE new 170-A Audio Chanalyst is a combination testing unit which includes the famous Voltohmyst circuit, a new diode flat through the audio range, a B.F.O. signal source, a gain calibrated amplifier, and speaker and line output connections.

The various channels of the RCA Type 170-A can be used independently or in unison to check

all common defects in audio amplifiers and sound systems. Polarity indication and a.c. can be determined instantly with the new electronic indicator, without danger of overload!

A pamphlet containing full description and specifications of the 170-A Audio Chanalyst will be sent gladly, on request.

Please use this coupon ↘

Test & Measuring Equipment, Dept. 97-87G
Radio Corp. of America, Camden, N. J.

Please send the bulletin describing the new RCA 170-A Audio Chanalyst to:

Name
Position
Company
Street City

BUY MORE WAR BONDS



RADIO CORPORATION OF AMERICA

RCA VICTOR DIVISION · CAMDEN, N. J.

In Canada:

RCA VICTOR COMPANY, LTD., MONTREAL

NEED PARTS?

National can supply you quickly with most of those hard-to-get parts at exceptional prices. Take a look at these bargains—

TUBE SPECIALS

All fully guaranteed
Types UX 200, 3L 8939c ea.
Types 39, 6F8G, 6SN7GT, 4S, 5549c ea.
Types 6SL7GT, 6Z5, 1T4, 3S459c ea.
Types 7H7, 7N7, 2269c ea.
Only these types available, while they last, do not ask for others.

6 ft. Electric Cord Sets, high grade, soldered, molded, rubber plug at one end, stripped and tinned at other.
Each, 29c; 10 for \$2.75; 100 for \$24.60

3,000 m.f.d. at 3v F.P. Condenser in aluminum can 1½ D X 2¼ H. Fresh stock. Special, while they last. Each\$1.39
10 for\$11.99

A Superior Mike Cable, single conductor, shielded, and pre-war natural rubber cover
13c per ft.; 100 feet, \$9.90

CONTINENTAL CARBON RESISTOR KIT No. C6 Assortment. 100 RMA coated ½ and 1 Watt resistors (2/3's are one watt). Unusual bargain at....\$3.35

AERIAL KIT containing aerial wire, rubber coated lead-in, insulators, ground clamp, window strip, etc.Each, 89c
20 MFD 150 WV Tubular Pigtail Electrolytic, One Year Guar.
Each, 35c; 10 for \$3.30

10 MFD 450 WV Tubular Pigtail Electrolytic, One Year Guar.
Each, 43c; 10 for \$3.95

Deluxe assortment of 50 Bakelite Set Screw Knobs for ¼" Shaft.....Kit, \$4.19
50 MFD 150 WV Tubular Pigtail Electrolytic, One Year Guar.
Each, 49c; 10 for \$4.45

ASSORTMENT OF 147 FIRST LINE 600WV TUBULAR BY-PASS CONDENSERS CONSISTING OF 64 .01-600WV, 32 .02-600WV, 24 .05-600WV, 27 1-600WV. One Year Guarantee. List Price, \$33.30. **\$11.95**
Your cost only.....

Assortment of 200 pcs. Special Radio Hardware including Tube Sockets, Terminal Strips, Grid Caps and Plugs.....Kit, \$1.49
20x20/150WV Tubular Electrolytic. First Line Condenser. One Year Guarantee. Each, 61c; 10 for \$5.60

BALLAST TUBES — K42B, K42C, K49B, K49C, K55B, K55C, L49B, L49C, L55B, L55C.....Each, 45c; 10 for \$3.99
100-37, 100-70, 100-77 and 100-79.
Each, 59c; 10 for \$5.45

Continental Bakelite Suppressors — S19A (Straight type with Rajah spring snap-on connector, fits all makes of spark plugs. Terminal nut cable connector).
Each, 18c; 10 for \$1.65

HI-TEMP RUBBER PUSH BACK WIRE—Solid and Stranded (#20)
100 Ft. Roll, 71c; 10 for \$6.50

LOCTAL SOCKETS — (Metal Supporting Ring).....10 for \$1.10; 100 for \$9.99

10 MFD 50WV Tubular Pigtail Electrolytic Condenser. One Year Guar.
Each, 28c; 10 for \$2.45

10x10/450WV Tubular Electrolytic. First Line Condenser. One Year Guarantee. Each, 74c; 10 for \$6.90

Assortment of 25 Muter Candohm Wire Wound Resistors (All are 7 to 15 W, 15 or more are between 100 and 500 Ohms).
Assortment, \$4.99

20% Deposit required on all C.O.D. orders. Don't forget L-265 or AA-3 Certificates. Orders of \$25.00 or more, accompanied by payment in full, will be shipped prepaid.

Free Bulletin No. 1095 lists hundreds of other radio parts and supplies. Write for it today!

**NATIONAL
ELECTRONIC SUPPLY**

77 W. Washington Blvd. Chicago 2, Ill.

produces a signal of a characteristic frequency in the converter output. During the change from each instrument to the succeeding one, a special contact in the sequence switch shorts the modulation line, cutting the modulation to zero. This shorted time is approximately one-fifth of the time between switch contacts; hence, if the switch is scanning at the rate of 80 instruments per second, the duration of the signal from each instrument is 15 milliseconds and the duration of the zero modulation is 4 milliseconds. (It has been found that the system operates most efficiently at about 60 contacts per second.)

When the signal reaches the ground, the third stage into which it is fed consists of a rectifier and filter. The rectifier converts all of the signal-section to half-wave pulsing direct current, and the filter is tuned to 60 cycles so that out of it comes a 60-cycle voltage which has been formed by the alternations of signal and zero-signal. The 60 cycles are amplified through push-pull parallel 807's to about 100 watts in a 500-ohm line, and fed to a 1/20 horsepower synchronous motor. This motor is used as a brake on a universal motor (110 v.a.c.) which drives the main switch and comparator potentiometer. The main motor is controlled by a variable voltage transformer to a speed slightly greater than that of the aircraft switch, and the synchronous motor brakes the system down to the exact speed desired.

We have found this system to be highly accurate and capable of maintaining synchronism through radio noise which was loud enough to disrupt intelligibility. The instrument switching rate of 60 cycles is purely nominal, because it has been found that the system will maintain itself at 40 to 90 instrument readings per second.

In the input of the recording circuit

is a condenser to which the direct-current voltage from the first input path is switched. This potential is in direct ratio to the original instrument position, and is used as the bias on the control grid of a type 2051 thyratron tube. The positive end of the condenser is connected to one of 80 wiping arms on a potentiometer.

At the instant the potential is impressed, the wiping arm is at the ground end of the potentiometer; and at the time after the switch has moved on to successive condensers, the arm starts riding up the potentiometer, the opposite end of which is maintained at a positive potential slightly greater than the greatest anticipated signal of direct-current voltage (in this case about 40 volts).

When the arm reaches a positive potential of a dimension to neutralize the bias maintained on the tube by the condenser charge, the tube becomes conductive and causes another condenser to discharge through a special paper, where a mark is left. The paper is a brand called Teledeltos Type "L," manufactured by Western Union Telegraph Company. It has three elements so laminated that, when current passes through the paper, the top layer is destroyed, leaving a black underlayer showing through and indicating a spot.

Two parallel rollers are included in the mechanism for measuring the above-mentioned signal potential. Each carries a 30-inch strip of recording paper. Each 30-inch strip of paper is divided into five 6-inch sections, and each section is close to and facing a 5¼" trolley, which represents the actual height of each chart and which carries the discharge-marking current.

A thin steel belt is located between the paper and the trolley. This belt supports the "pens," small flexible elements which make electrical contact between the trolleys and the recording paper. The belt moves around the

The front portion of the ground-based receiver unit of the flight recorder. It is a Link receiver, matched by crystal control to the transmitter frequency.

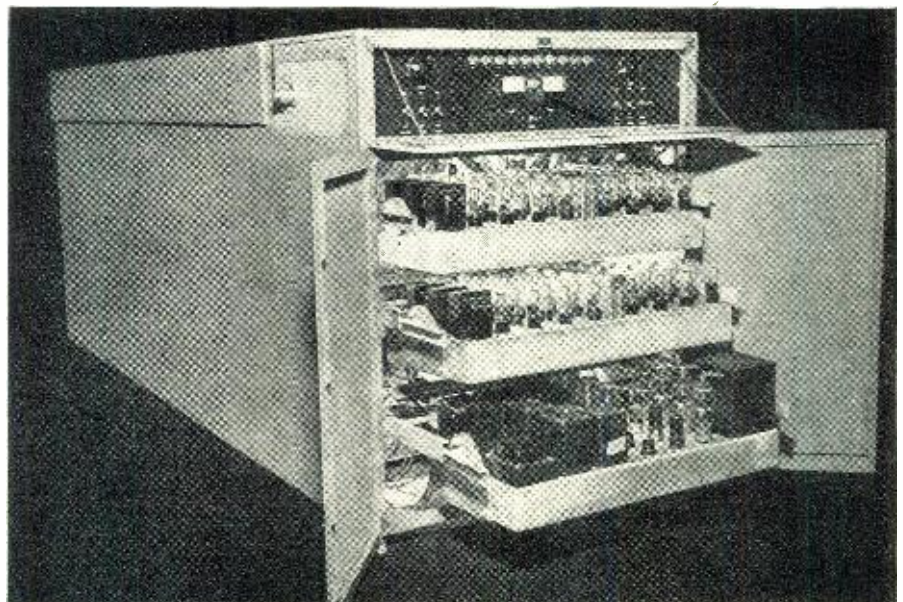

WHERE BUT MT. CARMEL

WOULD YOU EXPECT TO FIND
SKILLS LIKE THESE?

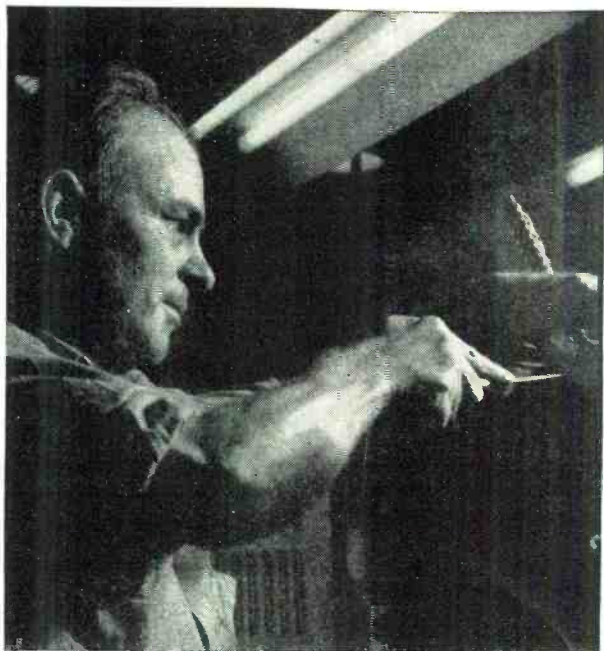

Sure, deft, hands—No compromise with quality here at Meissner as "precision-el" produces vital electronic war equipment.



Precisioneer—The years of experience this Meissner veteran brings to his job are just another reason why the Meissner products you use will do your job better.

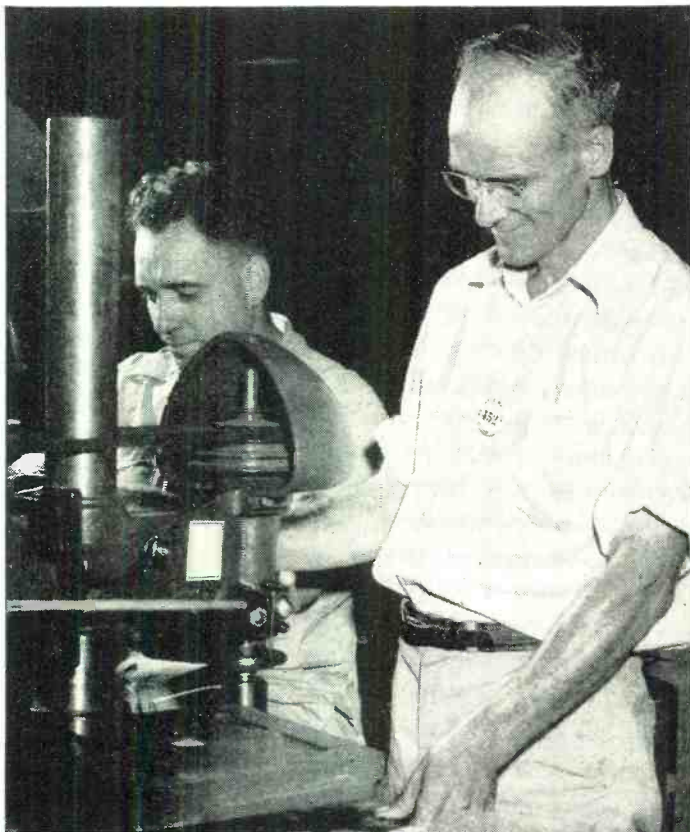

Concentration with a smile—One more reason for the precision performance of Meissner products. It's a smile of pride in a job well done that helps make personnel "precision-el."



Easy Way To "Step Up" Old Receivers!

Designed primarily as original parts in high-gain receivers, these Meissner Ferrocart I. F. Input and Output Transformers get top results in stepping up performance of today's well-worn receivers. Their special powdered iron core permits higher "Q" with resultant increase in selectivity and gain. All units double-tuned, with ceramic base, mica dielectric trimmers, thoroughly impregnated Litz wire, and shield with black crackle finish. Frequency range, 360-600. List price, \$2.20 each.



MEISSNER

MANUFACTURING COMPANY • MT. CARMEL, ILL.

ADVANCED ELECTRONIC RESEARCH AND MANUFACTURE
Export Division: 25 Warren St., New York; Cable: Simonrice

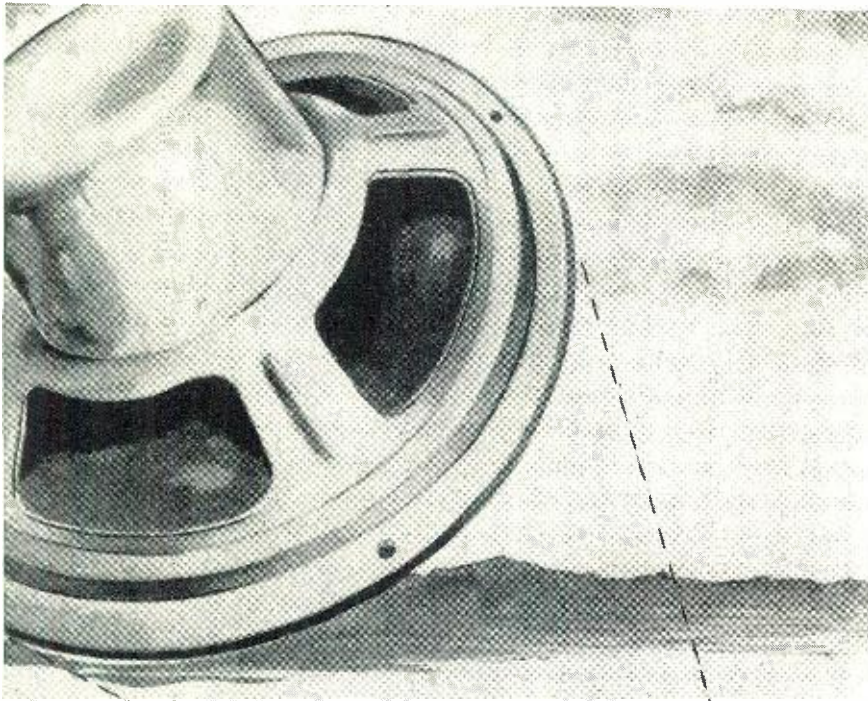

PERMOFLUX *First*
with a *Complete*
SPEAKER LINE!

**2" to 7½" Diaphragms in ½" Steps
plus 10", 12" and 15" sizes . . .**

No longer will it be necessary to choose a dynamic speaker to accommodate design requirements "as nearly as possible." The new Permoflux line of "true dimensioned" speakers covers the entire size range - there is a unit engineered to the exact needs of every design - there are speakers to provide power handling capacities from 1 to 20 watts. Incorporating exclusive Permoflux acoustic principles developed for war, these speakers mean new efficiency and tone revelation. Our engineering department invites consultation on your postwar sound design problems.

BUY WAR BONDS FOR VICTORY!

TRADE MARK
PERMO-FLUX

PERMOFLUX CORPORATION
4916-22 W. Grand Ave., Chicago 39, Ill.

PIONEER MANUFACTURERS OF PERMANENT MAGNET DYNAMIC TRANSDUCERS

pulleys at either end of the unit, carrying the pens across each chart position in succession; and the pens are spaced and so positioned that, as the pot wiper arm starts its climb, a pen starts moving across the corresponding chart.

When the wiper arm reaches the high end of the pot, the pen will have reached the high end of the chart. Then, while the pot wiper is moving across the dead (ground) space of the pot, the condenser in the grid circuit of the 2051 receives its charge and the next pen in sequence moves into position to start its travel across the chart. Accordingly, when the charge on the condenser is neutralized by the pot voltage, the 2051 will "fire," causing the condenser in the plate circuit to discharge. This discharge is carried through the circuit comprising the condenser, trolley, pen, paper, and tube; and a mark is left on the paper at that point. Therefore, the distance of the spot from the low end of the chart is directly proportional to the original charge on the condenser of the 2051. As it is set up and now operating, this system gives an accuracy between the condenser charge and the spot location of plus or minus less than .0025 per cent. The paper is "rolled" transversely to the direction of the pen motion at the rate of about 1/32" per second; and, when signals are being transmitted at the rate of 80 per second, the spots appear about 1/32" apart, forming an almost continuous line as the plot for each instrument.

Together, these give us the composite picture of the airplane, instantaneously and accurately. Once we relied upon motion pictures and "magic eye" cameras to record instrument indications. If an experimental airplane crashed, odds favored the records being mutilated. Now, thanks to electronic recording, we can know what took place up to the instant of crash, and perhaps find from those records how to avoid a repetition. In any event, electronic recording marks great progress in flight-testing of aircraft.

-50-

**International
Short-Wave**

(Continued from page 56)

dies, heard at 8:45 p.m., S-5 and S-6. "Voice of Free Arabs"—10.005, heard weakly at 2:40 p.m., Sundays.

Radio Eire—9.595, Athlone, Ireland, heard with good signal of S-7 to S-9, at 5:15 p.m. to signoff at 5:18 p.m., giving soccer scores and sports news. Asked for Canadian and U. S. reports.

JLT3—15.225, Radio Tokyo, heard S-8 to S-9, at 7:10 p.m. with news in English.

HER4—6.340, Bern, Switzerland, heard 30 decibels above S-9, very strong at 10:10 p.m. Signoff was at 11 p.m.

Mr. Bromley added that he also receives Leopoldville, Brazzaville, fairly regular. He occasionally hears SUX,

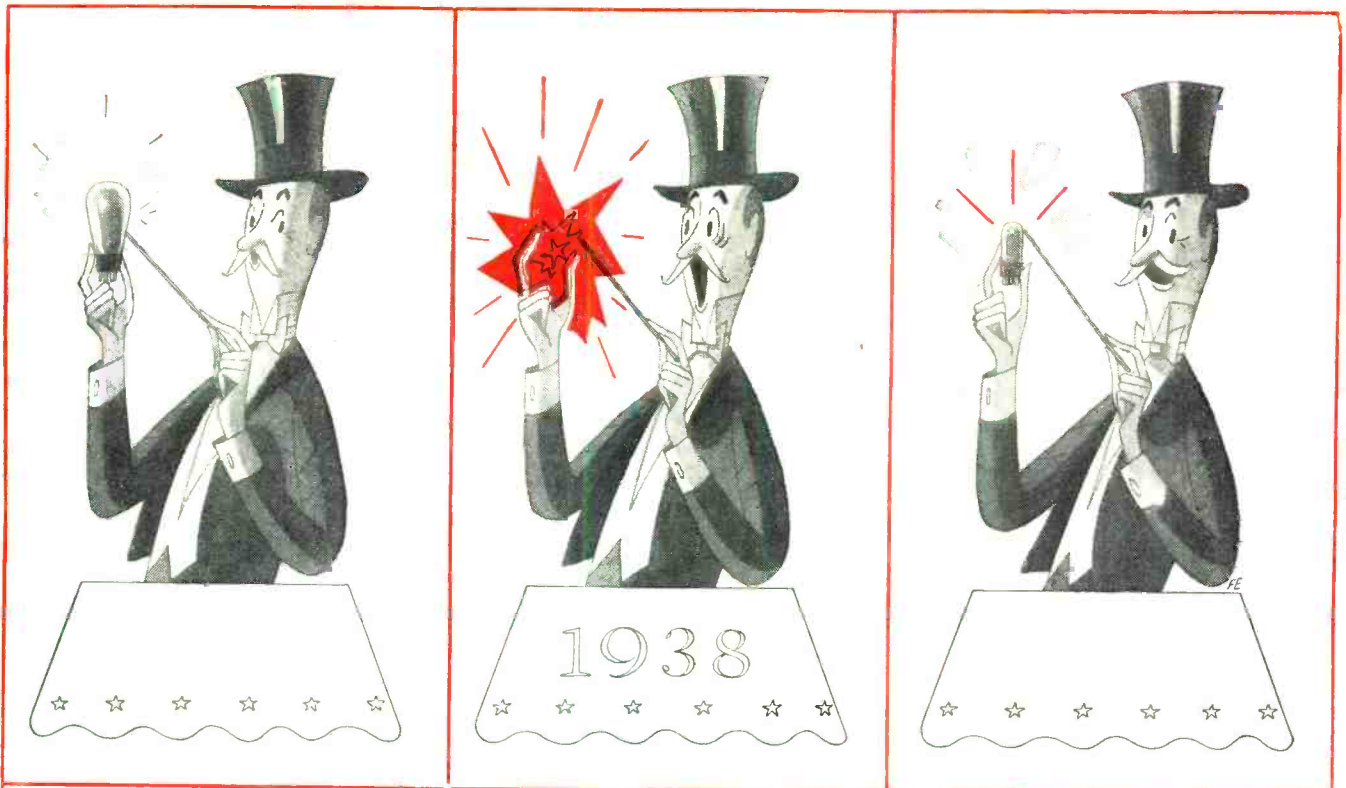

THEY SAID IT COULDN'T BE DONE!

Back in 1938, Hytron began designing new dies and converting production machinery for the first BANTAM GT tubes. The industry said in effect: "You're crazy; it won't work. You can't telescope standard glass tubes to BANTAM size and get the same results." Beam tetrodes, such as the 50L6GT, particularly were considered impossibilities. The intense heat developed during normal operation would warp the elements and crack the small glass bulb.

But Bruce A. Coffin, originator of the BANTAM GT, stuck to his guns. In a few short years, Hytron developed over fifty GT types. The GT became the most popular receiving tube.* Short leads, low capaci-

ties, advantages of shorter bombardment at lower temperatures, ruggedness of compact construction plus both top and bottom mica supports, smaller size, standardized envelopes and bases — all contributed to that popularity.

The BANTAM GT permitted new space economies in pre-war receivers. Only its universal acceptance as standard by all manufacturers makes possible fulfillment of the Services' demands for receiving tubes. In increasing numbers, as this war draws to its ultimate conclusion, Hytron will continue to supply you with the popular BANTAM GT tubes which everyone said just couldn't be made.

*1941 industry production figures: GT—52,000,000; metal—27,000,000; standard glass, G, and loctal—56,000,000.



OLDEST EXCLUSIVE MANUFACTURER OF RADIO RECEIVING TUBES

HYTRON
CORPORATION ELECTRONIC AND RADIO TUBES

SALEM AND NEWBURYPORT, MASS.



BUY ANOTHER WAR BOND

9 out of 10
BUSY RADIO
TECHNICIANS SAID

"HERE'S THE WAY
TO LEARN
RADIO RIGHT!"

GHIRARDI
TEACHES IT TO YOU
EASIER • BETTER • FASTER

724 OUT OF 817! When you want the fact about something—go to the men who know! When you want to find out what is the best Radio-Electronic Training for YOU—ask Radio-Electronic men! That was exactly our idea when we went to a mixed group of 817 radio-electronic men—a group made up of instructors, students, repair men, radio-electronic experts in the armed forces and in big manufacturing plants. We asked them to tell us exactly what they think of various books and courses now being offered for the study of Radio-Electronic fundamentals. NINE OUT OF TEN of these men wrote back that Alfred A. Ghirardi's RADIO PHYSICS COURSE book is their choice as the best buy on the market—far better than any other book or course they have ever seen. And, as they explained—

HERE ARE THEIR REASONS WHY:

- 1 "It's simple, clear way of thoroughly explaining every detail makes it the most easily understood of all Radio-Electronic books and courses.
- 2 "It teaches Radio-Electronic fundamentals more quickly and more interestingly than any other.
- 3 "It gives the most complete coverage of Radio and Electronic subjects—all in one handy volume.
- 4 "It is the most inexpensive, complete basic training available—easily worth from \$50 to \$100 if you bought it as a course."

TRAIN AT HOME—In Spare Time

Ghirardi's RADIO PHYSICS COURSE is tried and tested. It gives MAXIMUM training in MINIMUM time and at an absolute MINIMUM cost. You learn at home in spare time. You progress as fast as you want to. Actually Ghirardi's RADIO PHYSICS COURSE gives you the scope of 36 different courses in one—all packed into an easy-to-follow 972-page book with 508 clear illustrations, and 856 self-testing review questions. You can understand every word of it without previous training—and you'll be pleasantly surprised how easily you'll master the subjects that other books and courses make seem very complicated. Our 5-day Money Back Guarantee enables you to examine this great book for five full days—and get every cent of your money back if you're not more than satisfied.



Let A. A. Ghirardi—Radio's most widely-read technical author—help you start your training for a fascinating, profitable, wartime or peacetime job in the vast new Radio-Electronics field.

MAIL THIS COUPON NOW!

RADIO & TECHNICAL DIVISION
Murray Hill Books, Inc.
 Dept. RN-25, 232 Madison Ave., New York 16, N. Y.

Rush me a copy of your big, 972-page RADIO PHYSICS COURSE BOOK. I am enclosing \$5. (\$5.50 foreign.)

Send C.O.D. (in U.S.A. only) for \$5 plus postage.

In either case, I may return the book within 5 days for refund if I am not completely satisfied with it.

Name

Address

City (and Dist. No.) State



ONLY \$5
Complete
 (Postpaid in the U.S.A.)
 Easily worth \$50 if you bought it as a course

NO OTHER COURSE LIKE IT

There is no substitute for Ghirardi's RADIO PHYSICS COURSE—simply because there isn't any other book or course like it at any price. That's FACT—not fiction—and backed up by PROOF, not mere claims!

M. J. Turim of Brooklyn, N. Y., says: "I've read many Radio books but have failed to find a more detailed, thorough, and easy-to-understand book than Ghirardi's Radio Physics Course. It's the best course on the subject available today—ABSOLUTELY UNBEATABLE."

J. R. Robertson, Jr., of Bessemer, Ala., says: "As simplified, complete and understandable a Radio-Electronic Training Course as I have ever seen AT ANY PRICE."

ELECTRONICS, TOO!

And don't forget, RADIO PHYSICS COURSE does not end at reaching you only Radio! The basic instruction you get from this big book is your introduction to the vast, rapidly growing field of Electronics, too. It is your "Open Sesame!" to more money and a better job in this amazing new industry you've been reading so much about.

Order your copy today. SEE it. EXAMINE it for yourself. Here is our GUARANTEE:

YOUR MONEY BACK IN 5 DAYS
 If Ghirardi's Big 972-page RADIO PHYSICS COURSE doesn't teach you RADIO-ELECTRONIC fundamentals EASIER, FASTER, and at LESS COST than any other book or course.
YOU BE THE JUDGE!

COMPLETE BASIC RADIO-ELECTRONIC TRAINING IN ONE BIG VOLUME

Cairo, on 7.860 mc., around 4 p.m. with Oriental music. Two or three other African transmitters are heard irregularly. "I regularly pick up most of the South American stations, and usually can hear the British, French, Spanish, and German stations almost daily," he continues. "I can generally count on bringing in India two or three times a year; I hear the Japanese transmitters fairly often also, but as yet have not brought in any of the Chinese stations, or the Philippines. My location and antenna are only fair. My aerial is a 20-foot long one, running northeast by southwest. My Hammarlund HQ-120X has done good work. I have a high static level here and therefore the weaker stations are very hard to pull through," Mr. Bromley concludes.

PRISONER-OF-WAR MESSAGES

GERMANY—Prisoner-of-war messages from Americans interned in Germany are heard after the news, 10 minutes after the hour to the half-hour, from 9 p.m. on during North American service (5:30 p.m.-1 a.m.) over DXJ, 7.24, DXG, 6.19, and sometimes over DXP, 6.03, and DJD, 11.77; also reported over DXB, 9.61.

JAPAN—Radio Tokyo relays messages from American prisoners-of-war interned in Germany during the German hour each Saturday only, 12:30-1 a.m. over JVU3, 11.897, and JZL, 9.535. Messages from American prisoners-of-war interned in Japan are heard now 2-2:30 p.m. over JZL, 9.535 and JVW, 7.257, as well as JVV3, 11.725. Messages from Japan also are heard, 12-12:30 a.m. and 2:30-3 a.m. over JVU3, 11.897, JZJ, 11.80, JZL, 9.535 ("Humanity Hour") and "The Postman Calls" heard 2:30-3 a.m.).

WEST COAST REPORT

From August Balbi, Los Angeles, we have the following report this month: VLC2, 9.68, 12:15-12:45 p.m. to Britain; news, 12:15 p.m., replacing VLC8, 7.28, Shepparton, Australia. JVU3, 11.897, JZJ, 11.80, JZL, 9.535, Tokyo, 8:30-10:45 p.m., Home Service. JLT, 6.19, 7-8:15 a.m.; English news, 8:45 a.m. on 8:30-10:40 a.m. transmission; also heard, 11 a.m.-2:40 p.m., with news at 2 p.m. for Far East.

J—?, 6.11, heard 1-5 a.m., or later in Home Service. XGOI, 7.48, Shanghai, 7:15-11 a.m., news, 8:15 a.m., Home Service. XGOO, 9.66, Shanghai, 8-11:30 a.m., heard irregularly; bad QRM most days. XGOY, 6.17, Chungking, was on 6.07 and 6.04 for one day recently but is now back for good on 6.17, strong signal; also heard on 7.15 with fair signal; bad QRM. The transmission is from 7:35-11:40 a.m., with English news at 10 a.m. On 9.646, XGOY now is heard, 12 noon to 1 p.m., with news in English at noon. XGOA, 9.725, Chungking, is still on this frequency, but is seldom heard now. PIRM, 6.14, Manila, heard 4-9 a.m., with English news at 8:30 a.m.; fair.

Delhi, India, 7.30, now heard 7:30-10:30 a.m., with news at 9:30 a.m.; signal fair to good. On 7.21, heard 9-10:30 p.m., BBC news at 9:45 p.m., weak to fair. On 6.19, heard 10:50 a.m. to noon; news, 10:50 a.m. followed at 11 a.m. by BBC news relay; QRM'd badly by JLT Tokyo; also heard 8:30-10 p.m., with BBC news relay at 9 p.m.; relays General Forces Program in English from London, badly QRM'd by DXG, Berlin; strong signal some days. On 6.06, Delhi is heard 9-11 a.m., replacing 6.01; some QRM, fair signal. Alma Ata, USSR, 8.815, heard 8 a.m. on-midnight, in parallel with 9.565 often; Home Service.

Petropavlovsk, Kamchak Peninsula, USSR, 6.07, 5-6 a.m., daily, and Sundays only, 1:13-2:40 a.m., Home Service; best SW signal ever heard here.

RW15, Khabarovsk, USSR, 5.935 now heard midnight-10 a.m. or later; strong, some code QRM; Home Service.

Madagan, USSR, 5.715, heard from 3:30 a.m. on; Home Service; fair signal.

Moscow-Komsolmosk, USSR, 11.885 and 15.23, 6.47-7.25 p.m., to U. S. in English; best on 11.885, strong signal; modulation very poor; barely understood.

Komsolmosk, USSR, 9.565, heard 2:30-3:15 p.m., 3:33-5 p.m., 10 p.m.-1 a.m.; Home Service; good signal; seldom heard now after 2:45 a.m.

VE9AI, Edmonton, Alberta, Canada, 9.54, has a new schedule of 10:15 a.m.-8 p.m.; and on 6.005, 8:15-10:15 a.m., 8 p.m.-2 a.m.; news at 10 a.m.; 1 a.m.

Berne, Switzerland, 7.38, 6.34, 6.165, heard 9:30-11 p.m., off Saturdays; all in parallel; bad code QRM on 7.38, 6.34; also 6.165 QRM'd by CBRX; fair at times.

DXJ, Berlin, 7.24, is now back in operation to North America, 5.50-12 midnight; strong, irregularly.

DXG, Berlin, 6.19, a new station to North America, 5:30 p.m.-1:15 a.m.; very strong at times.

Radio Shonan (Singapore), now is heard, 6-7:30 p.m., with news in English at 7 p.m., on 15.45 mcs.

VDP2, Suva, Fijis, 6.135 now heard 1:55-5:30 a.m., with news in English at 2, 4, and 5 a.m.

LRS1, Buenos Aires, Argentina, heard 7 p.m.-12:30 a.m.

* * *

LAST MINUTE TIPS

LRU, Buenos Aires, 15.29, heard at 5:30 Sunday afternoon with concert; announcements of program in Portuguese, with station identifications in English. Algiers to New York heard S6 on 15.165 mcs. at 10:45 a.m. GRO, London, 6.180, ABSIE station, ends transmission at 9:45 p.m. (Richards, New York).

VLG3, Melbourne, 11.71, and VLC6, Shepparton, 9.615, beamed to the West Coast in the 2nd transmission to North America, 11:00-11:45 a.m., with English news at 11:00 and 11:35 a.m.; identified by the call of the Kookaburra bird; excellent. Radio Centre, Moscow, beamed to America, 6:48-7:25

(Continued on page 130)

These 2 GHIRARDI BOOKS

Will help you to Diagnose, Locate and Repair Receiver Troubles

EASIER • BETTER and FASTER



ALFRED A. GHIRARDI
—the man who makes Radio easy to learn



Ghirardi's Famous

MODERN RADIO SERVICING

The book that trains you quickly to MAKE MORE MONEY and get a bigger job as a Radio-Electronic repair technician BECAUSE it is by far the largest, finest, most easily understood how-to-do-it training course on the subject!

"Modern Radio Servicing" is the only single, inexpensive book that gives you a thorough training in the construction and working of all types of test instruments; receiver trouble-shooting procedure; circuit analysis; testing, repair, and replacement of individual receiver parts; installation; adjustments, maintenance; service shop management, etc.

No other book can compare with this one for complete, easily understandable instruction on every phase of service work. "I recently finished a course in Radio Repair at one of the N. Y. radio schools and all my learning at this school did not help me to understand and repair radios as quickly as did this one book. I made my money back on one job alone!" writes Henry Miller of Brooklyn, N. Y.

TEST INSTRUMENTS—TROUBLESHOOTING—REPAIR

You, too, can get a thorough and practical working training in Radio-Electronic servicing from this famous Ghirardi book—by yourself, in spare time at home—just as Mr. Miller and thousands of others have done. Its 1200 pages and 706 illustrations help you visualize every action. The 720 self-testing review questions help you check your progress. Progress as fast as you want to. It's the biggest servicing training bargain you can buy anywhere. You are protected completely by our 5-day money-back guarantee.

SPECIAL MONEY-SAVING COMBINATION OFFER!

Both books for only \$9.50 (\$10.50 foreign)

A total of OVER 2,000 PAGES of the world's most helpful and profitable servicing information!
5-DAY MONEY-BACK GUARANTEE

PRICE ONLY \$5 EACH!

RADIO TROUBLESHOOTER'S HANDBOOK

744 big pages, chock-full of just the kind of time-saving, money-making, tabulated and charted servicing data that servicemen are finding invaluable.

HERE'S HOW TO TEST A RADIO IN 2 MINUTES or less!

Ghirardi's RADIO TROUBLESHOOTER'S HANDBOOK isn't a "study book." It's an on-the-job data book to be referred to in your everyday work. For example, don't waste your time on complicated troubleshooting for every ailing receiver you are called upon to repair! First, look up its model number in the Big Trouble Case History Section of the Handbook which lists common troubles and their remedies for over 4,800 models of receivers and record changers.

MAKE MORE MONEY!

Nine times out of ten the Handbook will give you the exact clue you need to repair a receiver at once—often without any testing at all! Similarly, on tubes, parts, replacements, substitutions, color codes, circuit alignment, auto radio, batteries, vibrators, ballasts, grid bias resistors, condensers, transformers, tone controls, filters, etc., etc., you get pages of quick-find tabulated data to help do every repair job better—AND A LOT FASTER! This big new Handbook that weighs over 4 pounds is yours to use every day to make more money for only \$5 complete (\$5.50 foreign) and our Money Back Guarantee protects you. Order today!

5-DAY MONEY-BACK GUARANTEE

MAIL THIS COUPON NOW!

RADIO & TECHNICAL DIV. of Murray Hill Books, Inc., Dept. RN-25, 232 Madison Ave., New York 16, N. Y.

Enclosed find \$..... for books checked or send C.O.D. for this amount plus postage (sent C.O.D. in U.S.A. only). If not fully satisfactory, I may return books within 5 days and receive my money back

- Special MONEY-SAVING COMBINATION—Both books \$9.50 (\$10.50 foreign)
 RADIO TROUBLESHOOTER'S HANDBOOK, \$5. (\$5.50 foreign.)
 MODERN RADIO SERVICING, \$5. (\$5.50 foreign.)

Name

Address

City (and Dist. No.) State

**REPAIR ANY KIND OF RADIO EQUIPMENT
PREPARE FOR A BETTER JOB AS A RADIO-ELECTRONIC TECHNICIAN**

Bomber's Ears

(Continued from page 41)

take"—saved the lives of thousands.

Most people know the part radio plays at sea, but very few realize the important role radio has in combat flying. On a 15th AAF heavy bomber, the radio operator is a jack of all trades, a combination technician and combat man. As a result of an intense course in an Air Forces radio school, he knows the theory of radio, how to tune the sets in, and how to repair them; he must know code and how to quickly decode a message. Life moves quickly in the air, there's no room for second guessing; the radio operator has to do

everything right—the first time.

The radio operator also has been to an Air Forces gunnery school. In a Flying Fortress, he works a .50 machine gun mounted on top of the radio hatch. In the B-24 Liberator bomber, the radioman doesn't have his own gun, but usually takes over the waist or top turret guns in an emergency. Of the two, the Liberator man has the hardest job—he has to sit at his radio, sweating out the flak and fighters around him, without the solid satisfaction of shooting back that the B-17 man has.

Operating radios and guns is only a part of the radio operator's duties. He also may be called upon to use a camera over the target.

To understand the part radio plays in air battle, let's follow a Flying

Fortress as it takes off from its Italian base to bomb one of the Nazi oil refineries in the Balkans.

Before the plane takes off, the radio operator checks his own set, the command and v.h.f. sets of the pilot, and the navigator's compass radio set. There are several other radios on the plane that are used in case of an emergency.

Once in the air, the radio operator monitors his set, tuned to the frequency of his home base. He keeps a log of all messages, which of course are sent in code—a new code being used for each mission.

Over the target, or as soon as they encounter enemy fighters, he mans his gun, still monitoring the radio. The pilot may cut in, via the interphone, and call out, "Bandits at 3 o'clock!" Meaning that enemy fighters are coming in from the right.

"See them, sir," the radioman answers, tracking the approaching fighters with his machine gun.

As they make the bomb run, the radio operator looks into the bomb bay and tells the bombardier that all bombs are away, or that a bomb is stuck and will have to be salvaged.

If the fighter escort keeps enemy fighters away from the formation, the radioman uses his camera to take pictures of the bombs striking the blazing oil below. No matter what his job, he monitors his special frequency set at all times—the only connection between the bombers and their original base.

As the bombers head for home, the radio operator on the lead plane often radios the base, giving the results of the bombing. Except in cases of extreme emergency, the radio operator will not send a message while on the way to the target. It would be a dead giveaway as to course and target, and the Nazis would have a welcoming party of fighters waiting.

The command pilot in the lead ship may radio his bombers or the fighters special instructions, or order a change in formation—the pilot receiving this on his v.h.f. set—but this is done only in an emergency or when the enemy has already sighted the planes.

Returning to base, the pilot receives landing instructions—his position in the traffic pattern—via his command set. If there is a wounded man aboard, the pilot may drop a flare, or give instructions over the radio for an ambulance to meet them.

Only when wheels finally touch the runway does the radio operator turn off his set.

Should the heavy bomber become separated from the formation, perhaps crippled and lost in the clouds, the navigator uses his compass radio set to get his bearings. If forced down at sea, the radio operator sends out an S.O.S. on a special set.

The combat radio operator-gunner is probably the busiest man in the bomber crew, and radio communications are as necessary to a big bomber as are the wings or the four motors!

PORTABLE POWER PROBLEMS

THIS MONTH—BRISTOL PYROMASTER



INDUSTRIAL PROCESSES are accurately recorded, indicated and controlled by the Bristol Pyromaster Self-Balancing Potentiometer. In the illustration above, a Pyromaster maintains temperature control of a gas-fired furnace, used for case hardening steel parts.

DIRECT MARKING pen moves instantly and continuously at the rate required to follow temperature variations. A 1½ volt Burgess Battery supplies constant current to the potentiometer circuit. Burgess Industrial Batteries are designed to meet the exacting specifications of special instruments.

Write today about your specific needs. Free 80-page Engineering Manual on characteristics of dry batteries. Write Dept. N-6, Burgess Battery Company, Freeport, Illinois.

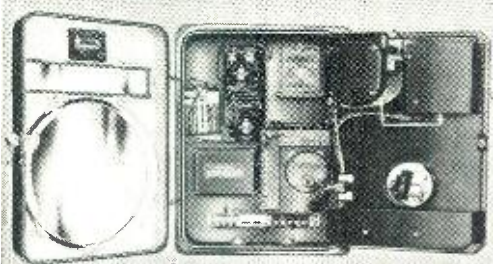

BURGESS BATTERIES



20 Years Experience In Parts Manufacture

- **CONDENSERS**—Variable, Fixed, Gas Filled Pressure, Neutralizing—a type for every transmitter need.
- **INDUCTORS**—Wire-wound, edgewise wound copper strip, copper tubing—fixed, tapped, or continuously variable—50 watt to 100 KW.
- **INSULATORS**—Stand-off, Thru-Panel, Cones, Bushings, Antenna Strain or Compression—a type for every requirement.
- **TUBE SOCKETS**—Steatite or Porcelain—Wafer, Bayonet, Miniature, Acorn or Special Types—a socket for almost any transmitting tube.
- **HARDWARE**—Tube Caps, Inductor Clips, Solder Terminals, Fuse Clips, Panel Bearings, Flexible Shafts—those hard-to-find constructional parts.

OTHER FAMOUS JOHNSON PRODUCTS

- Plugs and Jacks
- Couplings
- Concentric Line
- Chokes
- Antennas
- Antenna Phasing Equipment
- Antenna Coupling Units
- Heavy Duty R. F. Relays
- Make Before Break Switches
- Sampling Transformers

Ask for Catalog 968Z



JOHNSON

a famous name in Radio

E. F. JOHNSON COMPANY • WASECA • MINNESOTA

February, 1945

89

Transmission Lines

(Continued from page 31)

in this manner will do two things: the ratio of maximum voltage to minimum voltage will be changed and their locations will be shifted. The relative values of V_{max} and V_{min} may be read on the type of meters previously referred to as A or B, bearing in mind that with meter A the crystal must be calibrated and with meter B, the square root of the meter readings must be used. The location of V_{max} and V_{min} may be designated as so far from the receiving end and may be expressed in linear units (cm. or inches) or angularly in degrees or radians.

A special case exists when the terminating impedance is equal to the characteristic impedance. Here V_{max} equals V_{min} and there are no standing waves on the line. This is known as a matched or flat line and is the one we generally strive to attain. Since standing waves are caused by waves being reflected back from the load, they represent a certain amount of power not available to the load, hence a loss. Also, standing waves in high Q circuits give large current and voltage values, thus requiring the use of larger conductors and more insulation and therefore are undesirable. They also represent phasing problems when several antennas are fed from the

Fig. 9. (A) Showing the variations of voltage, current, and impedance points along a transmission line. (B) Illustrating the 90° phase shift between the voltage and current. (C) Illustrating graphically the impedance variation along the transmission line.

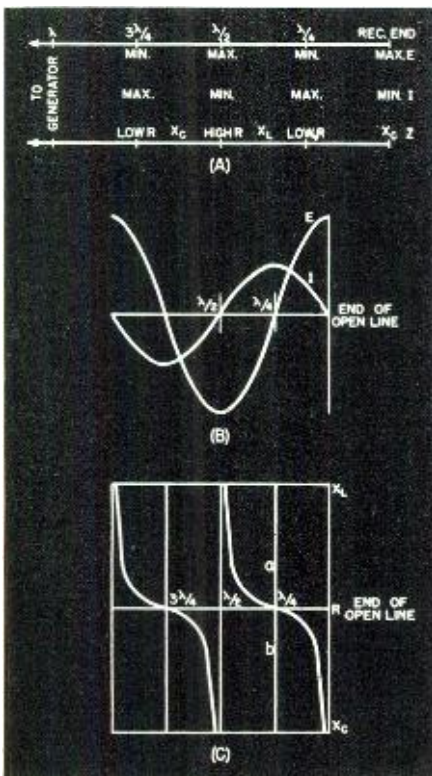

same line. Then again, ohmic losses are less in a flat line since the average current is lower. The line also will have less tendency to radiate. Another important consideration is that the impedance of a flat line does not vary with its length.

No standing waves will be found on the line under two conditions. The first is where the line is infinitely long and the voltage and current values become 0 before the end of the line is reached. Since we can have no reflection under this condition we will

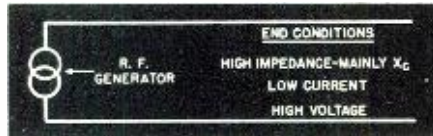

Fig. 8. Illustrating an open-end transmission line several wavelengths long.

have no standing waves and also no power will be available for the load. The second is where the load impedance equals the characteristic impedance and maximum power is available to the load. Under these two conditions we have but one choice but even this is not without its difficulties. If we apply the formula $Z_0 = 276 \log b/a$ and attempt to match the 73 ohms which a half-wave dipole antenna presents to the line, we find it physically impossible.

Matching Methods

It therefore becomes necessary to use a greater value of Z_0 , say several hundred ohms, and use some impedance-matching device. There are several ways of doing this. It could be done by using a closed quarter-wave or odd multiple section and tapping. See Fig. 5.

Stub Matching

Another, and one of the most important methods of matching a line to an antenna (see Fig. 6) is by means of stubs. The stub is a section with the same dimensions—except length—as the line. It is placed on the line usually at right angles to it and is so designed as to match the impedance of the line with terminating impedance. In this case the terminating impedance consists of the stub, the line beyond the stub and the antenna. It is complex, consisting of resistive and reactive components. The stub is placed on the line where the resistive component equals Z_0 . The reactive component may be either inductive or capacitive and must be cancelled by using an open or shorted stub which gives an opposite reactance of the same magnitude. We will endeavor to explain the technique of this operation at 200 mc., giving an example using figures taken with the equipment previously described.

Load the transmission line with a dipole, a quarter-wave on either side of the line, and make the following measurements, using meter B. 1. Location of V_{max} . 2. Magnitude of V_{max} . 3. Magnitude of V_{min} . 4. The wave-

length. The wavelength may be found by measuring the distance between two adjacent parts of V_{max} and multiplying the result by 2.

Great care should be exercised in making the measurements of V_{max} and V_{min} because the results depend largely upon them. The quarter-wave lines on the meter may be moved along the line at an angle, but when the readings are taken they should be at right angles. It must be remembered that the square root of the meter readings are to be used on account of the characteristics of the meter.

The calculations in the simplest form follow:

$$Q = V_{max}/V_{min}$$

$$K = \frac{Q - 1}{Q + 1}$$

where K is the reflection coefficient.

The location in degrees from V_{max} toward the sending end for the shorted stub may be found from:

$$\frac{(-\cos^{-1}K) \text{ plus } 180^\circ}{2} \dots \dots \dots (1)$$

The length in degrees for the shorted stub would then be:

$$\tan^{-1} \frac{\sqrt{Q}}{Q - 1} \dots \dots \dots (2)$$

For those not familiar with these notations, the first formula reads

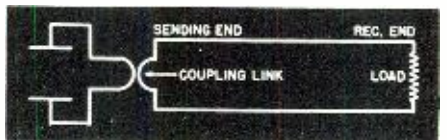

Fig. 7. A two-wire balanced transmission line, using 3/8-inch copper tubing.

“minus the angle whose cosine is K plus 180° divided by 2.” The second reads “the angle whose tangent is $\frac{\sqrt{Q}}{Q - 1}$.” All you have to do is figure $\frac{\sqrt{Q}}{Q - 1}$ the value of the fraction and look up the corresponding angle in a table of natural trigonometric functions.

The distance to an open stub from V_{max} toward the sending end will be:

distance in degrees =

$$\frac{(\cos^{-1}K) \text{ plus } 180^\circ}{2}$$

and the length of the open stub is found from:

$$\text{length in degrees} = \tan^{-1} \frac{Q - 1}{\sqrt{Q}}$$

Meter C should be placed near the sending end and the length of the quarter-wave line on meter B should be adjusted for minimum deflection on meter C as meter B is moved along the line.

It will be noticed that the results

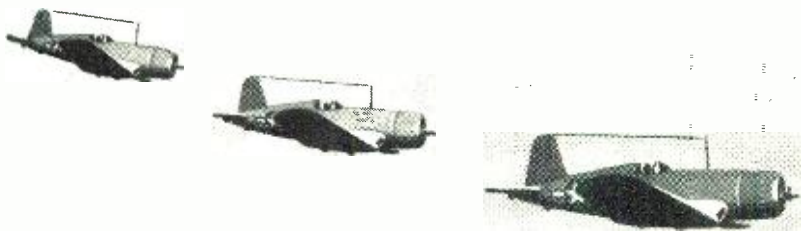

Engineering Vision . . . Manufacturing Precision

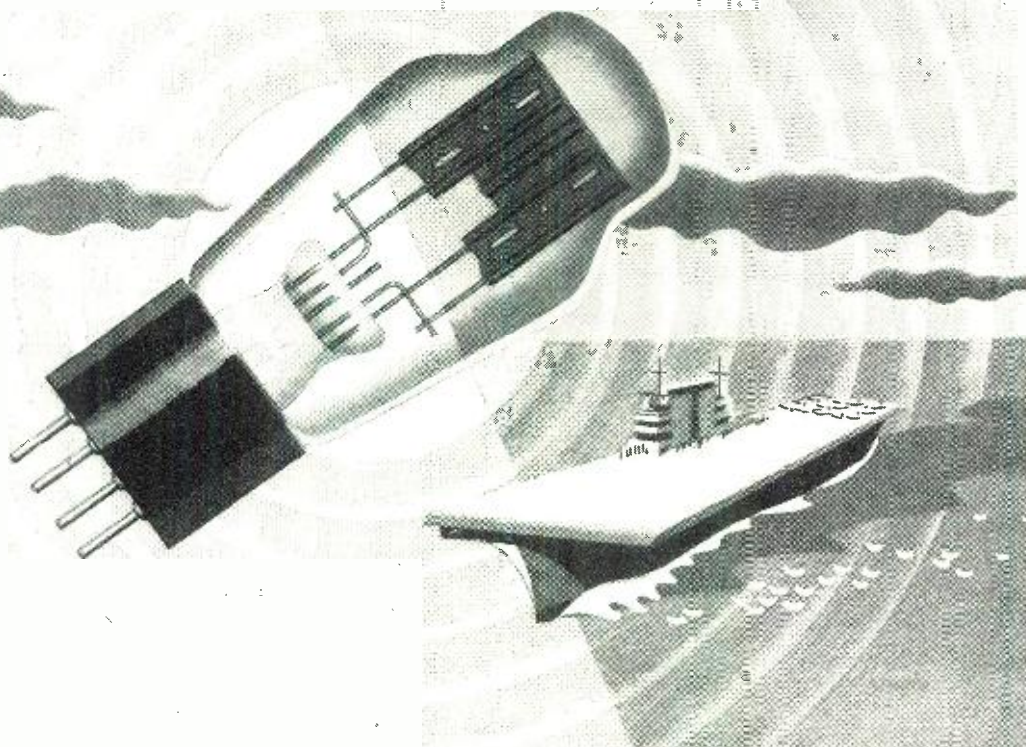

In ships at sea, in fighter and bomber planes, at command posts and in tanks and vehicles . . . Delco Radio products are carrying out vital assignments for the fighting forces. They represent the application of radio and electronic science to varied requirements of communication, detection and protection. They represent, too, the effective combination of engineering vision and manufacturing precision that safeguards the performance of all Delco Radio equipment, wherever it serves and whatever its purpose. Delco Radio Division, General Motors Corporation, Kokomo, Indiana.



**Make Your Dollars Fight
BUY MORE WAR BONDS**

are given in degrees. This makes the method flexible so that it may be applied to any wavelength. To convert to linear units such as centimeters or inches, use $\frac{x}{360}\lambda = D$

where:

- x = length or position in degrees
- λ = wavelength
- D = linear units as selected

Here is an actual example taken with the equipment described. The measurements were

1. V_{max} from the receiving end was found at 38 and 113 cm.
2. Magnitude of V_{max} was $\sqrt{75}$

3. Magnitude of V_{min} was $\sqrt{9}$
4. Wavelength from (1), $(113 - 38) \times 2 = 150$ cm.

The calculations were:

$$Q = \sqrt{\frac{75}{9}} = 2.88$$

$$K = \frac{2.88 - 1}{2.88 + 1} = .485 = \cos 61^\circ$$

Position of shorted stub

$$\frac{-61 + 180}{2} = 59.5^\circ$$

Converting to cm. $\frac{59.5 \times 150}{360} = 24.8$ cm. from V_{max} , or

$24.8 + 38 = 62.8$ cm. from antenna

Length of shorted stub =

$$\tan^{-1} \frac{2.88}{1.88} = \tan^{-1} 0.902 = 42.1^\circ = 17.5 \text{ cm.}$$

Similarly, using the formulas for the open stub, the position was calculated to be 50.25 cm. from V_{max} and the length 20 cm. The position of the stub from the antenna is $50.25 + 38 = 88.25$ cm. Since this is more than a half wavelength, we should move the stub 75 cm. toward the receiving end and place it at 13.25 cm. This is possible because all the conditions on the line recur every half wavelength, the preferred positions being nearest the antenna.

Hints and Kinks

Persons with limited experience with ultra-high frequencies probably will be bothered by all sorts of manifestations not usually encountered at lower frequencies. For instance, a person moving in the room where the work is going on, may cause the deflections on sensitive detector meters to vary. There is no way of avoiding this except to have all the conditions surrounding the equipment as stationary as possible.

In tuning up the oscillator, it may be found that the plates will get redue to excessive current. Try adjusting the L-C ratio of the plate tank circuit. Try to get a no-load current of 50-60 ma.

Getting the so-called quarter-wave lines on meter B to offer enough impedance so that there is little effect on the line, is sometimes difficult. The reason for this is that we are never sure just what our meter adds to the circuit. It may add inductance or capacitance depending on the construction of the meter. The solution is to place meter C near the sending end and adjust the lines for minimum change on meter C as meter B moves along the line.

Watch out for over-coupling when the line is being used as a Lecher system. All points of V_{max} must be equidistant without minor humps in between.

When taking readings of relative voltage using a crystal and d.c. meter, the crystal must be calibrated. The method is to terminate the line with a resistance and use an amount of coupling which will give a V_{min} near the bottom of the meter and a V_{max} near the top. Plot the readings on the meter against degrees along the line, for a half wavelength. Then superimpose a sine wave on the crystal curve using the same maximum and minimum points. The readings on the crystal curve should then be projected on the sine curve to get their true relative values.

RIDER VOLUME XIV COVERS 1941-42 RECEIVERS



That's me three years ago. The first program I carried was Frank Sinatra — back in the days when a bobby sock was something worn by a London policeman.

My, how we 1941 models have worked since then. For most of us it's been too much and many of my contemporaries are now piled up in overcrowded service shops.

There is one bright spot however. Rider Manual Volume XIV is now off press. Carrying complete authorized servicing information on 1941-42 sets, we ailing sets are sure of correct diagnosis and quick painless repair.

But please be patient if your jobber's supply of Volume XIV is inadequate. He, and the Rider folks will get you your volume as fast as present WPB limitations permit.

- RIDER MANUALS (14 VOLUMES)**
Volumes XIV to VII . . . \$11.00 each volume
Volumes VI to III . . . 8.25 each volume
Abridged Manuals I to V
 [1 volume] . . . \$12.50
Automatic Record Changers and Recorders . . . 6.00
OTHER RIDER BOOKS YOU NEED
The Cathode Ray Tube at Work
 Accepted authority on subject . . . \$3.00
Frequency Modulation
 Gives principles of FM radio . . . 1.50
Servicing by Signal Tracing
 Basic Method of radio servicing . . . 3.00

- The Meter at Work**
 An elementary text on meters . . . 1.50
The Oscillator at Work
 How to use, test and repair . . . 2.00
Vacuum Tube Voltmeters
 Both theory and practice . . . 2.00
Automatic Frequency Control Systems
 —also automatic tuning systems . . . 1.25
A-C Calculation Charts
 Two to five times as fast as slide rule . . . 7.50
Haur-A-Day-with-Rider Series—
 On "Alternating Currents in Radio Receivers"—
 On "Resonance & Alignment"—
 On "Automatic Volume Control"—
 On "D-C Voltage Distribution"90c each

JOHN F. RIDER PUBLISHER, INC. 404 Fourth Avenue, New York 16, N.Y.
 Export Division: Rocke-International Electric Corp. 13 E. 40th Street New York City Coble: ARLAB

RIDER MANUALS are complete **IN 14 VOLUMES**

Federal Tubes...

come **CLOSER** to the

PERFECT VACUUM

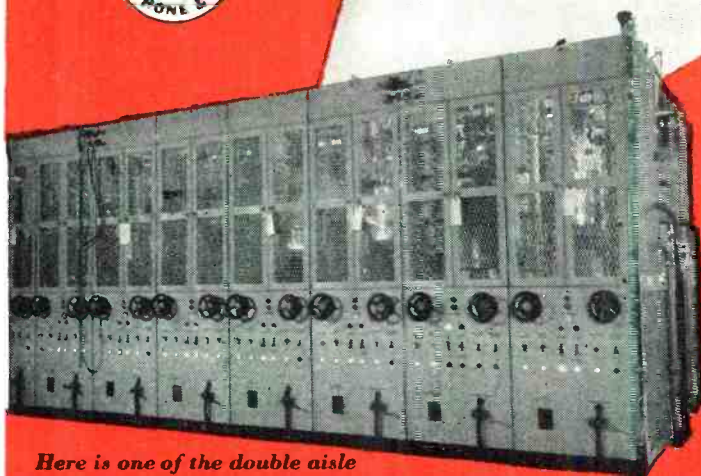

Here is one of the double aisle exhaust banks where 16 high power tubes can be exhausted at one time, each with individual control.

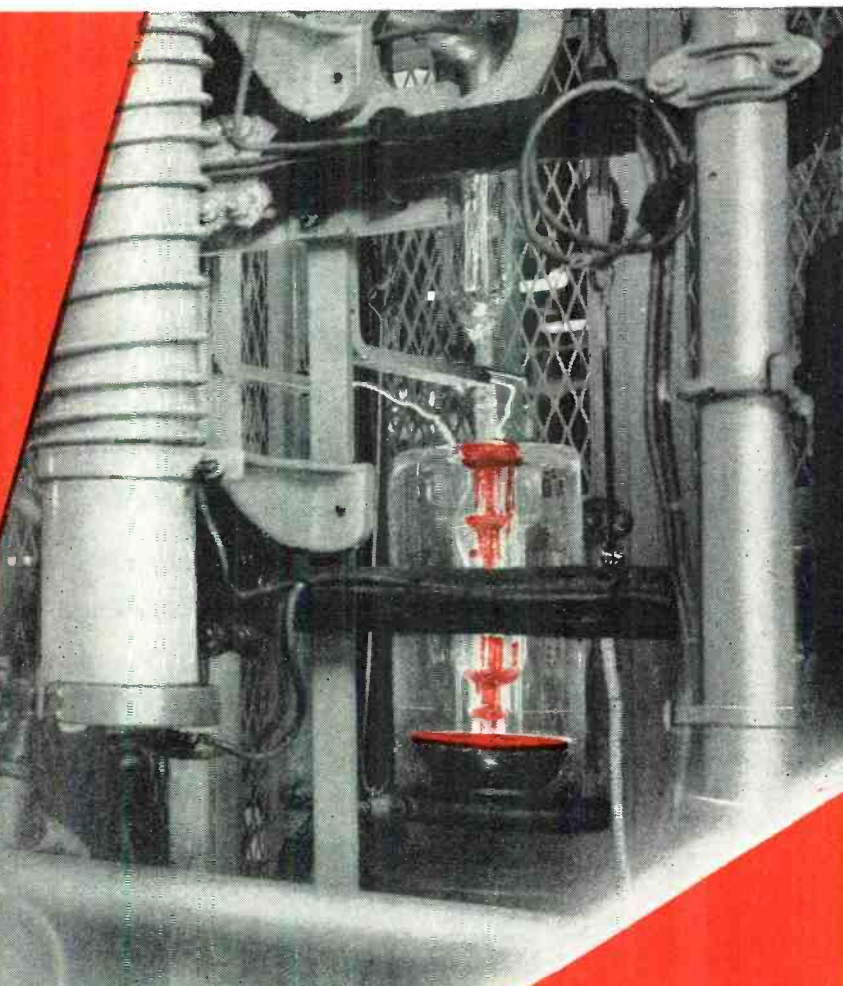

Always in the forefront of tube research and development, Federal makes another advance and now has added exhaust units of entirely new and original design to its production equipment.

This latest Federal achievement produces a tube that is substantially closer to the perfect vacuum—a tube with greater efficiency and longer life.

Arranged in banks of eight and operated with identical control equipment, these units exhaust uniformly every size of Federal tube—assuring a consistent and high standard of quality.

For any communication and industrial power tube need, turn to Federal now—test its reputation that “Federal always has made better tubes.”

Federal Telephone and Radio Corporation

Newark 1, N. J.



ALLIANCE "Even-Speed" Phono-motors

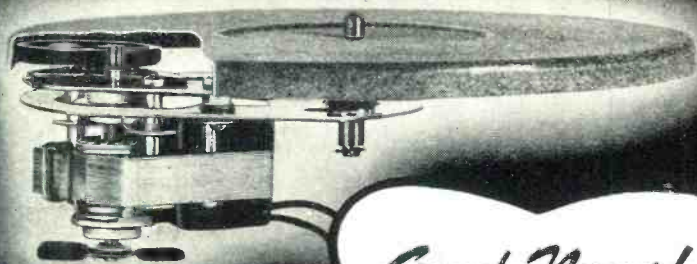

Good News!

ALLIANCE RESUMES PRODUCTION on One Standard Model

• We are now able to return to production of one standard variation of Alliance Model 80 Phono-motor, according to the following definite specifications and on the production plan explained below.

STANDARD SPECIFICATION No. 811—Turntable No. Y-278-S2; 110 Volt, 60 cycle, 9" Model 80 Production must be on the following practical basis under present conditions where there are no large volume priority orders—namely, by accumulating a sufficient quantity of small orders with necessary priority and making periodical single production runs at such time as the quantity of accumulated orders is enough to make this practical. Priority orders (currently only orders of AA-3 or higher, with GOVERNMENT CONTRACT NUMBER and MILITARY END USE, or where certified to be used in Sound Systems, Intercommunications or Paging Systems, as exempted from under M-9-C) must allow delivery time required to obtain a minimum practical production run; to procure material for all orders in hand, and make one production run of the one type standard unit only, for shipment on the various accumulated orders. • Check the above against your requirements, and if you have proper priority, communicate with us.

REMEMBER ALLIANCE—Your Ally in War as in Peace!

AFTER THE WAR IS WON, WE WILL TELL YOU ABOUT SOME NEW AND STARTLING IDEAS IN PHONO-MOTOR

ALLIANCE MANUFACTURING COMPANY
ALLIANCE, OHIO

STAMINA



The inherent stamina of Cinaudagraph Speakers is due to experience in design and manufacturing plus highest inspection standards. In all types of Cinaudagraph Speakers, from small watch-like Handie-Talkie units to large auditorium speakers, you'll find the same precision, the same painstaking workmanship and the same long-lived faithful reproduction.

Watch Cinaudagraph Speakers after Victory!



Cinaudagraph Speakers, Inc.

3911 S. Michigan Ave., Chicago
Export Div., 13 E. 40th St., New York 16, N. Y.

"No Finer Speaker Made in all the World"

A few more do's and don'ts. Keep line meter probes at right angles to the line. The probes must make good contact. Keep the line and antenna as far away as possible from other objects. Do not separate the lines more than 1.5 inches for 200 mc. Fluorescent lamps when fired take power from the line and therefore should be separated from the line as far as possible. Another way of using the lines as a Lecher system is to place meter C near the sending end and move a shorting bar along the line.

There is a great deal more to this subject, but this much will keep you busy for a while and you will have learned the basic theory of transmission lines.

-30-

Filter Design

(Continued from page 40)

ous rectifier tubes such as the 866, the load current should not exceed about 25% of the rated peak current of one tube when a full-wave rectifier is used, or 1/2 the rating with half-wave rectification.

A bleeder resistor should be used with both a condenser input and a choke input filter to keep the voltage from rising to its peak value and so provide better regulation, and to discharge the filter condensers in case the load is removed before the power is turned off. The bleeder should have a resistance such that it draws from 5% to 10% of the full load current. The actual value is not critical. The resistor should be capable of dissipating the heat generated without being damaged. The power dissipated in the resistor is given by the equation:

$$W = I^2 R = E/R \dots \dots \dots (7)$$

where I is the current through the resistor, and E is the voltage across it. The actual wattage rating should be about twice that calculated to avoid excessively high resistor temperatures.

The filter condensers should have a d.c. working voltage rating at least equal to the peak voltage of one half the transformer secondary and preferably a little higher to provide a safety factor. As with the choke input filter, two or more condensers may be connected in series to give an adequate working voltage rating. In general, electrolytic condensers are used where the voltage does not exceed 450 volts, as they are much cheaper and smaller than paper condensers of the same capacity rating.

If the current drain from the power supply is rather small as in the case of small a.c.-d.c. receivers, the filter choke may be replaced by a small resistor. This impairs the filtering action somewhat, but with large condensers, the filtering may still be adequate for the particular location. The decrease in cost and weight more than makes up for the necessary increase in the size of the condensers.

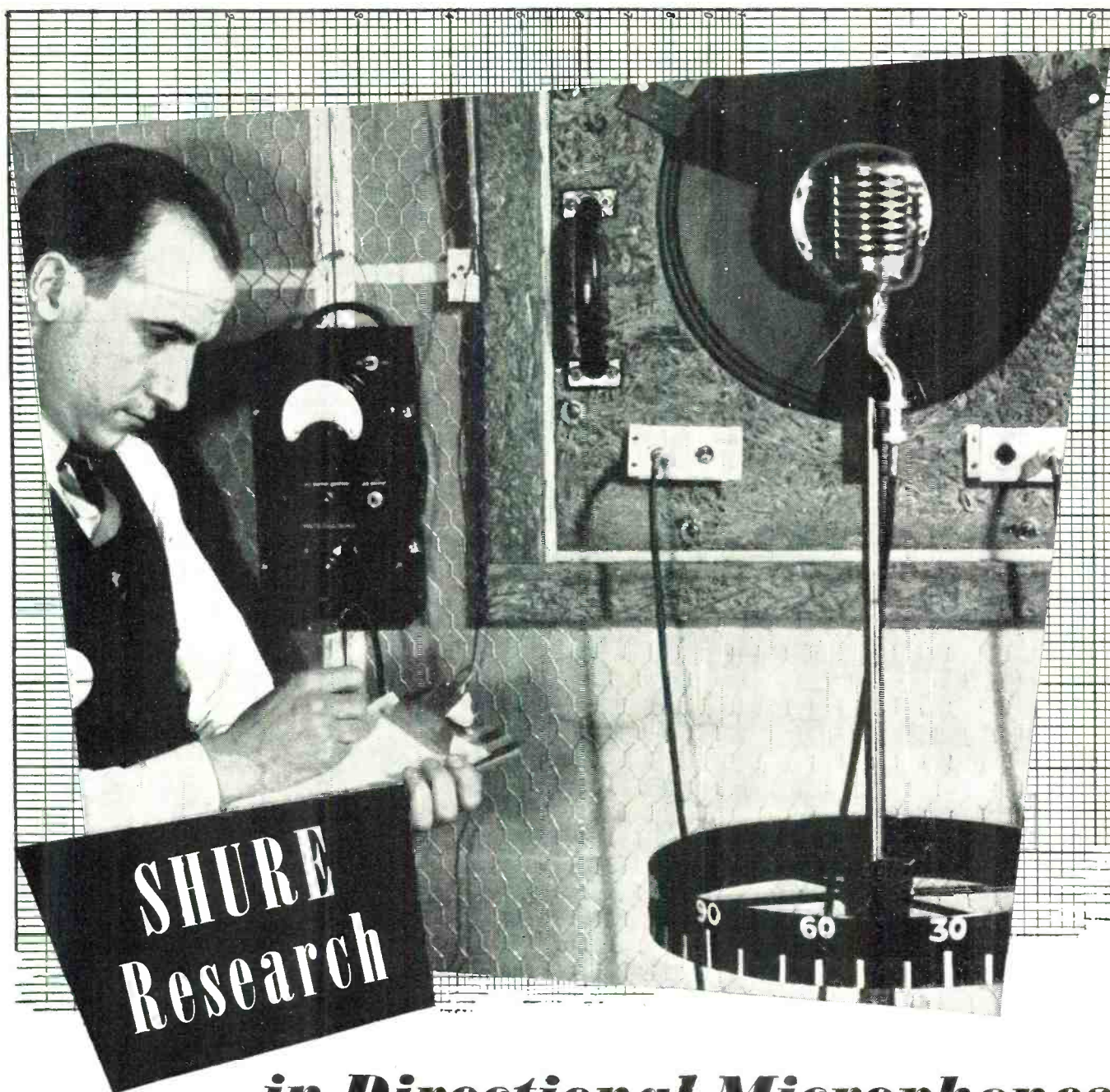

... in Directional Microphones

It is not enough to design a Microphone that merely converts sound waves into electrical impulses. A Microphone, to be truly useful in modern broadcasting, should be discriminating enough to accept wanted sounds — and reject unwanted sounds. Shure Research was the first to develop a single unit uni-directional Microphone, both crystal and dynamic.

Shure Research is the reason why practically every major broadcasting station uses the Shure 556 Unidyne. Shure Research is your assurance of postwar microphone superiority.

SHURE BROTHERS, 225 West Huron Street, Chicago
Designers and Manufacturers of Microphones and Acoustic Devices



The properties of condenser and choke input filters are somewhat different, and their applications are correspondingly different. For a given rectifier, the output voltage from a choke input filter will be lower than from a condenser input filter, but the regulation will be better. Consequently, choke input filters are ordinarily used where good regulation is desirable, as in applications where the load may vary over quite wide limits. Also, choke input filters are used to keep the peak rectifier current down, a condition which is desirable when mercury vapor rectifier tubes are used. Condenser input filters are widely used in low-voltage, low-power applications where high-vacuum rec-

tifier tubes are used. Such applications are domestic radio receivers, small public-address systems, low-power transmitters, phonograph amplifiers, and similar devices.

In all the above filter designs, care should be taken to see that the LC combinations are not resonant at the ripple frequency, or some harmonic, as this may introduce an excessively high ripple voltage in the output, and may puncture the condensers. The resonant frequency for the choke input filter is $1/2\pi\sqrt{L.C.}$. For normal values of inductance and capacity, the resonant frequency of a filter will be well below the ripple frequency.

It is possible to design resonant filters which are effective, but the

values of the components are quite critical, and any change in either inductance or capacity would greatly reduce the effectiveness of the filter. Resonant filters usually are designed with a parallel resonant circuit in series with the high-voltage lead to provide a high impedance at the ripple frequency, or a series resonant circuit across the supply to short circuit the ripple frequency. Resonant filters are not recommended for normal applications, such as radio receivers.

Sufficient information has been given above for designing a power supply filter for most normal applications. However, an example might serve to clarify the procedure.

Suppose a low-power audio amplifier is being designed. The power requirements are 350 volts at 75 ma. A full-wave rectifier operating from a 60-cycle supply line is to be used.

Because of the small power requirement in this case, a condenser input filter with a high-vacuum rectifier is chosen. An input condenser of 8 to 10 $\mu\text{fd.}$ will be satisfactory, and the d.c. working voltage should be at least 400 volts, and preferably 450 volts. The peak voltage rating should be 600 volts, as the peak value of the transformer secondary will approach this value.

A bleeder resistor which will draw between 5 and 10% of full-load circuit must be provided. This will mean approximately 5 ma. at 350 volts, or 70,000 ohms. The power dissipated in this resistor will be, from Eq.(7), $(.005) \times 70,000 = 1.75$ watts. A 5-watt resistor, two 2-watt resistors (140,000 ohms each) in parallel, or two 2-watt resistors (35,000 ohms each) in series, would be suitable.

To determine the size of the output condenser, the total load resistance must be calculated. The total load current is $75 + 5 = 80$ ma., the voltage 350 volts, so from Ohm's Law ($R = E/I$), the load resistance is $350/.080 = 4,375$ ohms. From Eq.(6), assuming a minimum frequency response of 50 cycles per second, the output capacity should be $C = 10^7/\pi \times 50 \times 4,375$, or about 15 $\mu\text{fd.}$ A 16- $\mu\text{fd.}$ condenser should be very satisfactory.

A choke with a value of about 20 henrys at 80 ma. will give adequate filtering for the amplifier. From Eq. (4), it is seen that the choke and second condenser alone would reduce the ripple to about $1/3$ of 1%, and the input condenser will bring the ripple well below this value.

There is one other factor which should be considered in purchasing a choke. Since it is connected to the B+ supply and the frame is invariably grounded, the choke winding must be well insulated from the core.

In designing a filter for any purpose, it always pays to purchase quality parts with adequate current and voltage ratings in order to get satisfactory performance over a long period of time.



WE'VE GOT THOSE HARD TO GET RADIO PARTS!

SEND FOR OUR LATEST FLYER TODAY!

You'll be surprised at the many hard-to-get parts we've been able to get for you fellows. Mikes, multi-testers, meters and many other items. They're yours as long as they last. Send for latest flyer. It's full of merchandise you've been trying to get! Stocks won't last long, so write today.



QUICK SERVICE!

Our central location in the heart of the nation makes it possible to give you quicker service.

In these days of scarcity we have done everything possible to bring you the best in radio parts and equipment. In spite of existing shortages we have made available thousands of items as shown in our printed circulars.

We are determined to give you the same quick service on "hard-to-get" parts as thousands have enjoyed in the past. Because parts move so rapidly these days we intend to continue our policy of publishing an up-to-date list of merchandise every two or three months.

As additional equipment is released, we will be the first to have it. If you are not on our list to receive our flyers—mail the coupon today.

Sincerely,
Les W. Ferguson
W9GFQ

WE SPECIALIZE IN HALLICRAFTERS

Service men all over the world are learning that the name "Hallicrafter" stands for quality in radio equipment. For many years we have been one of the country's largest distributors of Hallicrafters—"the radio man's radio." We have Hallicrafters available for immediate delivery on priority. For all particulars, write us today

WHOLESALE RADIO LABORATORIES

744 WEST BROADWAY COUNCIL BLUFFS, IA.

OUR LATEST GET-ACQUAINTED OFFERS



TUBE AND CIRCUIT REFERENCE BOOK

Here's a handy reference book that meets the demand for simple, easy to understand data on substitution of radio tubes. Contains valuable technical information on tubes and circuits. It's a guide you'll refer to time and again. Send for your copy today! Only 10c post-paid.

TUBE-BASE CALCULATOR ONLY 25c



Here's just the calculator you've been looking for! Tells you quickly, tube characteristics that enable you to substitute available tubes for those hard to get. Only 25c. We pay shipping expense.

FREE Giant Radio Reference Map

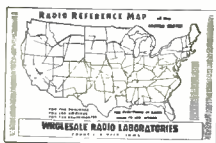

Time zones, amateur zones, short wave stations. Other valuable information. Printed in colors; size $3\frac{1}{2} \times 4\frac{1}{2}$ ft. Yours free! Send 15c to help with packing and mailing.

Mail Coupon Today

Wholesale Radio Laboratories RN-1
744 West Broadway
Council Bluffs, Iowa

- Send your reference book "Tubes and Circuits." Here's my 10c
- You bet I want a Tube-Base calculator 25c is enclosed
- Ship me your free radio map. 15c is enclosed for packing and mailing
- Send your free flyer of hard-to-get radio parts

Name.....
Address.....
Town..... State.....



We're cooking up New Answers in Plastics

RADIO-FREQUENCY preheating is an important development in plastic molding. It makes new applications feasible and many better cures possible—and it can increase your daily production. It's something to look for when you select your plastics molder.

Look for this too. A full installation of preheating equipment is important—but complete equipment plus extended experience in its use means a whole lot more. The machines will suddenly be available to everyone after the war. The experience won't.

At Kurz-Kasch, we've been building up preheating technique since the first R.C.A. radio-frequency machine was delivered to us for experiment back in early 1943. We've got plenty of all kinds now, and we know how to design for them, estimate for them, and use them.

If you want this kind of progressive thinking in your molder—and want it backed up by a solid record of accomplishment dating back to the birth of the plastics industry—ask Kurz-Kasch to figure on your plastics application. Just ask for an engineer.

WHY KURZ-KASCH FOR PLASTICS?

Kurz-Kasch offers a 28 year old reputation for thoroughly-engineered, quality production. • One of the largest, best-equipped exclusive custom molding plants in the country—75,000 sq. ft. of floor space with 125 compression and transfer presses of all sizes. • Complete mold-making and finishing facilities. • Extensive production sequences of radio-frequency preheating equipment, with full experience in their use. • Complete insert-production shop. • For satisfaction in plastics, key these facilities into your production line.

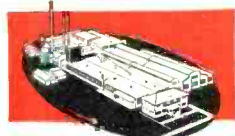

THE WAR BONDS YOU KEEP ARE THE BONDS THAT COUNT

Kurz-Kasch

For over 25 years Planners and Molders in Plastics

Kurz-Kasch, Inc., 1429 South Broadway, Dayton 1, Ohio. Branch Sales Offices: New York • Chicago • Detroit • Indianapolis • Los Angeles • Dallas • St. Louis • Toronto, Canada. Export Offices: 89 Broad Street, New York City

Cathode Follower

(Continued from page 55)

the load is connected in the cathode circuit. From an arrangement of this sort, a low-impedance output may be obtained.

"The principle of operation is degenerative; that is, a signal of approximately 100 volts peak may be applied to the cathode-follower grid. The cathode, not being tied to ground, follows this voltage to such an extent that the grid is never positive with respect to cathode. The available output voltage is therefore less than the input voltage.

"The output of the preamplifier is low impedance . . . the line may be run any desired distance to the modulator chassis. This allows the driver transformer to be at the grids of the power tubes."

Grid to ground capacitance in the cathode follower is unaffected by the negative feedback voltage and this advantage enables one to use the circuit as a probe for measurement of wave shapes with a scope. Some circuits used in producing certain pulses are so easily upset that the capacity of conventional test leads destroy the original wave shape before it is viewed on the scope. Thus, a true picture of the wave under test is not obtained.

By feeding the test wave directly into a cathode follower we are able to pass the original signal on to a scope without creating any unbalance.

Working backward from the original use of a cathode follower it has been found that such a circuit may be used

to couple a low-impedance source to a high-impedance input circuit with a good match, no distortion, and no phase shift. Such a use might occur where video signals were involved and no transformer of the desired characteristics could be located.

By placing a steady bias on the grid of a cathode follower and feeding the low-impedance source into R_k , the resulting plate output voltage of the stage may be fed into the high-impedance circuit with the proper match and correct frequency response. See Fig. 5.

APPENDIX 1

$$e_{in} = e_g + i_p R_k$$

$$e_o = i_p R_k$$

$$i_p = \frac{\mu e_g}{R_p + R_k}$$

$$G = \frac{e_o}{e_{in}} = \frac{i_p R_k}{e_g + i_p R_k}$$

$$= \frac{\frac{\mu e_g}{R_p + R_k} \cdot R_k}{e_g + \frac{\mu e_g}{R_p + R_k} \cdot R_k}$$

$$= \frac{\mu e_g R_k}{e_g R_p + e_g R_k + \mu e_g R_k}$$

$$= \frac{\mu R_k}{R_p + R_k + \mu R_k} = \frac{\mu R_k}{R_p + R_k (\mu + 1)}$$

$$= \frac{\mu}{\mu + 1} \cdot \frac{R_k}{\frac{R_p}{\mu + 1} + R_k}$$

If μ is much greater than 1, then

$$\frac{\mu}{\mu + 1} = \frac{\mu}{\mu} \text{ or } 1 \text{ and } \frac{R_p}{\mu + 1} = \frac{R_p}{\mu} \text{ But}$$

$$\frac{\mu}{R_p} = G_m \therefore \frac{R_p}{\mu} = \frac{1}{G_m}$$

$$\text{Thus Gain} \cong \frac{R_k}{\frac{1}{G_m} + R_k}$$

APPENDIX 2

$$i_p = \frac{\mu e_g}{R_p + R_k}$$

$$e_g = e_{in} - e' \therefore i_p = \frac{\mu (e_{in} - e')}{R_p + R_k}$$

$$e_o = i_p R_k = \frac{\mu (e_{in} - e') \cdot R_k}{R_p + R_k}$$

$$e' = e_o \therefore e' = \frac{\mu (e_{in} - e') \cdot R_k}{R_p + R_k}$$

Solve for e'

$$e' \cdot (R_p + R_k) = \mu R_k (e_{in} - e')$$

$$e' R_p + e' R_k = \mu R_k e_{in} - \mu R_k e'$$

$$e' R_p + e' R_k + \mu R_k e' = \mu R_k e_{in}$$

$$e' (R_p + R_k + \mu R_k) = \mu R_k e_{in}$$

$$e' = \frac{\mu R_k e_{in}}{R_p + R_k + \mu R_k} = \frac{\mu R_k e_{in}}{R_p + R_k (\mu + 1)}$$

$$e' = \frac{\mu}{\mu + 1} \cdot \frac{R_k e_{in}}{\frac{R_p}{\mu + 1} + R_k}$$

$$G = \frac{e_o}{e_{in}} = \frac{e'}{e_{in}} = \frac{\mu}{\mu + 1} \cdot \frac{R_k}{\frac{R_p}{\mu + 1} + R_k}$$

APPENDIX 3

$$Z_o = \frac{R_p}{\mu + 1} \cdot R_k = \frac{R_p R_k}{\frac{R_p}{\mu + 1} + R_k} = \frac{R_p R_k}{\frac{R_p (\mu + 1)}{\mu + 1} + R_k}$$

$$= \frac{R_p R_k}{R_p + R_k (\mu + 1)}$$

$$Z_I = \frac{R_p R_k}{R_p + R_k (\mu + 1)}$$

$$Z_I [R_p + R_k (\mu + 1)] = R_p R_k$$

$$Z_I R_p = R_p R_k - Z_I R_k (\mu + 1)$$

$$Z_I R_p = R_k [R_p - Z_I (\mu + 1)]$$

$$R_k = \frac{Z_I R_p}{R_p - Z_I (\mu + 1)}$$

If μ is much greater than 1, then Z_I is small compared with μZ_I , and

$$R_k = \frac{Z_I R_p}{R_p - Z_I \mu} = \frac{Z_I}{1 - Z_I \frac{\mu}{R_p}}$$

$$R_k = \frac{Z_I}{1 - Z_I G_m}$$

British and American amateur radio operators meet at Mostyn A.R.C. Club, London. All nine districts of the United States are represented by (left to right) T/Sgt. Albert Savage, Pawtucket, R. I., W1CPV; Cpl. Fred Roden, West Lebanon, N. Y., W2KED; Dan Stevens, O.W.I., Upper Darby, Pa., W3CBY; Chap. J. B. Andres, Skyland, N. C., W4EFG; Cpl. Mitchell Wiseman, Indianapolis, Ind., W5KSU; T/Sgt. John B. Barclay, Taft, Cal., W6OIT; Cpl. William Garbutt, Greybull, Wyo., W7GZI; T/Sgt. Omar H. Mitchell, Charleston, W. Va., W8KFZ; and T/4 Lloyd C. Dothe, Barnum, Minn., W9SYX.



HIGH Q COILS *by*

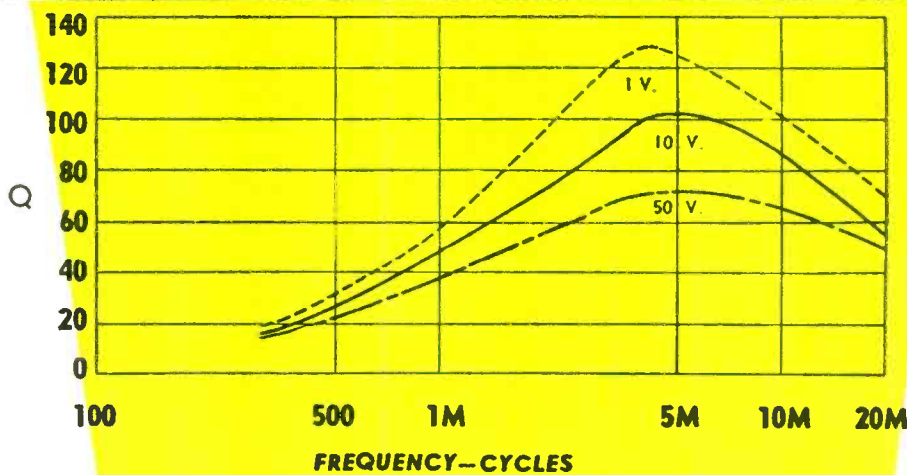
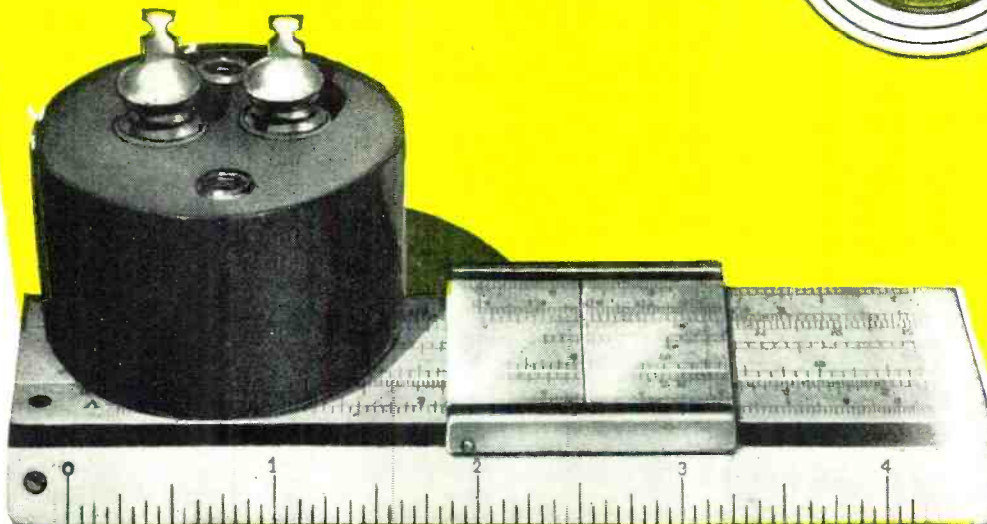

There are many applications in the audio field requiring coils of high Q and good stability. UTC coils of the type HQA series are ideal in this respect. Q CHARACTERISTICS of a typical .14 Mhy. coil at three voltages are illustrated. VOLTAGE STABILITY is high. At 1,000 cycles, for applied voltages from .1 to 25 volts, the change in inductance is less than 1%. DC current change in inductance is approximately 1% per 10 Ma. linearly.

MUM PICKUP is low due to a self shielding structure: . . . 70 microvolts per gauss at 60 cycles.

TEMPERATURE effects are negligible. From -60 degrees C. to plus 85 degrees C., inductance variation is less than 1/3%.

MECHANICALLY, these units are hermetically sealed in a drawn steel case 1-13/16" diameter by 1-3/16" high. Weight . . . 5 ounces.

VIBRATION effects are not evident over entire range of normal aircraft tests.

HQA UNITS are available in any inductance value from 5 Mhy. to 2 Hy., and are ordered as: HQA followed by value in Mhy. Typical semi-standard values are:

HQA-12.5	\$5.00 net	HQA-200	\$8.00 net
HQA-30	\$6.00 net	HQA-500	\$9.00 net
HQA-80	\$7.00 net	HQA-1250	\$10.00 net

United Transformer Co.

150 VARICK STREET

NEW YORK 13, N. Y.

EXPORT DIVISION: 13 EAST 40th STREET, NEW YORK 16, N. Y., CABLES: "ARLAB"



Practical Radio Course

(Continued from page 53)

course, is essential to this process. The action may occur in this way: If an undesired station (or stations) delivers an extremely strong carrier voltage to the tube, that tube may act as a rectifier. Therefore, overload of the tube will introduce rectification where it is not desired, and since a rectifier may eliminate a carrier while retaining its modulation, the modulation of this interfering station may be present distinctly in the tube circuit and become *mixed* with the carrier of the desired station. So the tube

acts as a rectifier and a mixer, and the audio component of the undesired carrier is modulated upon the other. Hence, the carrier of the *desired* station brings in the desired program but since it is also modulated by the audio pulses extracted from the *undesired* cross-modulating carrier, interference results.

When cross-modulation occurs, the first r.f. stages of the receiver usually are the guilty ones, but the necessary interfering signal pickup and detection causing it can also take place in the audio system if the conditions are satisfactory. The degree of vulnerability of the first stage to cross-modulation is a matter of tube and circuit design. Variable-mu (su-

per-control) type r.f. pentodes which have a much more extended cutoff characteristic than do screen-grid tubes (see Fig. 5), thus enabling larger input signal voltages to be applied and making possible the application of a higher bias for reduction of signal strength (volume control) without increasing the susceptibility of the stage to detector action or cross-modulation, are a great help when they are employed in the first r.f. stages. Also, providing sufficient selectivity *ahead* of the first receiver stage (ahead of the place where detection can occur) so that the presence of the undesired signals on the grid of the first tube is avoided, is probably the most effective preventative. In some receivers, extra link circuits are included in the antenna-stage tuning circuits especially for this purpose.

If an existing receiver is troubled by cross-modulation interference, the identity and carrier frequency of the interfering station should be established first. If the receiver design already provides a reasonable amount of selectivity in the antenna end, an ordinary wave trap having good attenuation characteristics and tuned to the frequency of the station causing the trouble will be effective. In some cases two wave traps may be necessary; a parallel-tuned rejector trap in series with the antenna and a series-tuned acceptor trap shunted across the receiver input is the best combination for obtaining the utmost attenuation against the interfering signal. Reducing the length of the receiving antenna, or the use of an effective type of noise-reducing antenna also will help.

It is possible, however, for the interfering signal to enter the receiver directly by way of circuits other than the antenna input. These may be the following:

- (1) Direct pickup by exposed grid circuits and wiring associated with early tuned stages.
- (2) Direct pickup by the tubes of the receivers (if not properly shielded).
- (3) Direct pickup by the power supply line.
- (4) Direct pickup either on the chassis or the ground circuit where this is mutual to an r.f. circuit.

Filtering the power line; shielding all exposed grid leads and wiring of the first stages (including under-chassis wiring); having ground of low r.f. impedance and short length; and even a change of the applied voltage or operating characteristic of the stage affected so as to reduce the level of the interfering signal voltage—or its effect—are effective remedies.

With the increase in the number of high-powered transmitting stations that are frequently located within comparatively short distances of each other (10 miles or so) another type of cross-modulation interference—occurring entirely *external* to the receiver (either t.r.f. or superhet type) has be-



TODAY in WAR..TOMORROW in PEACE

Today, BRACH produces only for Victory. But after the war, look to BRACH improved facilities, BRACH engineering and BRACH *quantity-plus-quality* technique as your most desirable source for Antennas for Home Radios, Autos, Television, Marine, F.M. and other services.

L. S. BRACH MFG. CORP.

World's Oldest and Largest Manufacturers of Radio Antennas and Accessories
55-65 DICKERSON STREET • NEWARK N. J.

Can You Substitute a 43 for a 50L6-GT?

BUY
WAR
BONDS

You can find out quickly by looking on page 12 of the RCA Tube Substitution Directory. You can also find out what changes are involved in substituting each of 9 other tube types for the 50L6-GT.

THIS is just one example of over 2000 substitutions listed in this directory, which was published by RCA to help you use available tubes in place of hard-to-get-types. Here's what's in it:

1. Numerical-alphabetical listing of more than 300 RCA receiving tube types.
2. In most cases, one or more types which can be used as substitutes. Suggested substitutions are keyed to cathode voltages and functional groupings in a "Classified Chart of Receiving Tubes."
3. Notations (with clear, detailed explanations) of space limitations, and the wiring, filament- or heater-

circuit, and socket charges involved in making the substitutions.

4. Sample calculations of series and shunt resistances in heater strings.

If you do not already have this valuable RCA Directory, ask your RCA distributor for a copy today... or fill out the coupon below and mail it, with 10¢ to cover mailing costs, to RCA, Commercial Engineering Section, Department 62-88R, Harrison, N. J.

This service help was produced by RCA to save your time. And in servicing sets today, time saved means extra dollars in your pocket. Keep looking to RCA for the kind of practical support that keeps extra dollars in your pocket!

The Magic Brain of all electronic equipment is a Tube... and the fountain-head of modern Tube development is RCA.

SEND FOR RCA
SUBSTITUTION DIRECTORY

61-6636-88



RCA, Commercial Engineering Section,
Dept. 62-88R, Harrison, New Jersey
Enclosed is 10¢ for TUBE SUBSTITUTION DIRECTORY FOR EMERGENCY
SERVICING OF CIVILIAN RECEIVERS. Please mail my copy at once to:

Name _____

Address _____

City _____ State _____

Listen to "THE MUSIC
AMERICA LOVES BEST,"
Sundays, 4:30 P.M.,
EWT, NBC Network



RADIO CORPORATION OF AMERICA

RCA VICTOR DIVISION • CAMDEN, NEW JERSEY

LEADS THE WAY . . . In Radio . . . Television . . . Tubes . . .
Phonographs . . . Records . . . Electronics



Versatile is the word for Atlas Sound's latest creation, the DR-12 Little Giant. Its construction assures equally gratifying service when used in marine application, factory, police and other communications . . . a design that has proven itself more than equal to War's rigorous demands.



Bell diameter 7"—over-all length 7½"
WRITE FOR DETAILED DESCRIPTION

ATLAS SOUND

CORPORATION

1447 39th Street

Brooklyn, N. Y.

If you want



- CRYSTALS
- CABLES
- HARNESSES
- ELECTRONIC ASSEMBLIES
- CABINETS

Telephone Peru, Indiana

151

Serving the Radio and Electronic Industries with precision engineered products.

Wm. T. WALLACE MFG. CO.

General Offices: PERU, INDIANA

Cable Assembly Division: ROCHESTER, INDIANA

come prevalent in the vicinity of these stations—especially where exposed open-wire power lines are in use. This type of interference is called *external cross-modulation*.

When two radio waves of sufficient strength encounter any elevated system of electrical conductors in which system there exists anything that causes rectification or detection—even though it be a relatively poor rectifier—numerous new spurious combination and harmonic radio frequencies are created. This is illustrated in Fig. 2 for the case of rectification of two original frequencies, A and B of 760 kc. and 710 kc. respectively. These new frequencies radiate from the system to nearby receiving antennas, and thereby are introduced into the receivers associated with them. When one or more of these interfering frequencies happens to fall at a desired station frequency, interference results. Since this cross-modulating action takes place entirely outside of the receiver, it causes interference that no receiver can avoid. Such interference is generally localized in a particular community.

Observation and experience have shown that the offending electrical system, whether it be power distribution, telephone system, or other aerial network of conductors (and particularly any network or system which is resonant to the local station frequency), can produce this interference if it has a rectifying tendency. Rectification may occur from poor joints or contacts, from an oxidized copper conductor in contact with another copper surface (producing a rectifier), from certain types of lighting arresters, special nonlinear devices, intermittent or poor contacts to earth or to other objects, and rectification due to chemical action at a joint or splice.

The "neutral" or "grounding" system for power circuits of the exposed overhead type is a frequent cause for generation of this type of interference. Also, it has been found that the trouble can be caused by contacts between electric conduits, plumbing pipes, and even from contacts of such piping with metal lath in walls through which they pass. In short, any electrical conductors exposed to very strong signals, and having a rectifying contact, can generate the spurious frequencies. Incidentally, a great many cases arise from faulty contacts in the antenna and ground circuit wiring of the receiver installation itself.

Familiar experiences of this type are those in which the interference changes with weather conditions, or where the output of the receiver varies in accordance with whether certain light switches are turned on or off. Cases also have been reported where the cross-modulation effect was so related to the lighting circuit that it was produced only when a certain switch was closed.

If this type of interference is experienced, it definitely should be iden-

Learn RADIO- ELECTRONICS- TELEVISION

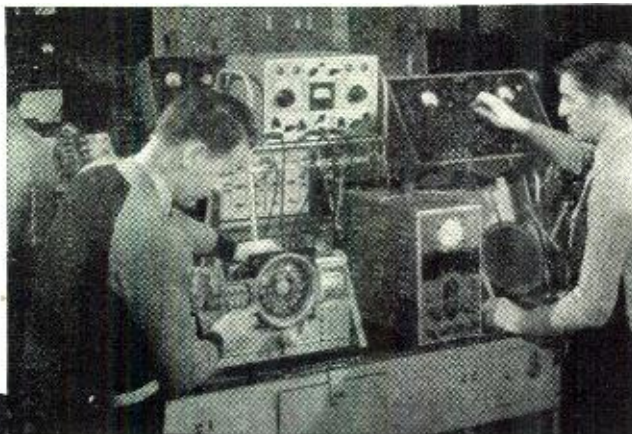

RADIO TESTING AND SERVICING—Students learning to locate troubles with modern radio analyzers.



ELECTRONIC CIRCUIT TESTING—Instructor showing students use of large Cathode Ray Oscilloscope.

TRAIN FOR A GOOD JOB NOW *that will* also be a GOOD JOB IN PEACE-TIME

Don't be caught napping. Prepare for a good essential job now that will still be a good job with a real future when the war is over. If you are not a trained man you may have to compete with millions of other untrained men. Get into a field that offers real opportunities in war times, peace-times—good-times and bad-times. Tremendous expansion in Frequency Modulation and Television is predicted after the war. Radio-Electronics trained men are needed today—they will be needed too when peace comes.

Real Opportunities for the Radio Trained Man

Prepare for jobs as assembler, inspector and tester—Radio sales or service and installation work, electronics, television, sound work, aircraft-radio, auto-radio, etc. Many opportunities in the vast Radio-Electronics field.

GET MY BIG NEW BOOK

It tells all about my big Chicago shops and my plans to help you get ahead. Packed with facts and pictures of students at work in my shops. Mail coupon for this Big New Book now! Coupon will also bring details on how I'll Finance Your Training . . . facts on how I help you "Earn-While-Learning" . . . information on FREE EMPLOYMENT SERVICE FOR LIFE . . . and other plans to help you. ACT NOW TO MAKE SURE YOU GET MY GENEROUS OFFER. Sending for this interesting free book can be your first big step to success. No obligation. No salesman will call. Mail coupon today.



H. C. Lewis

H. C. LEWIS, Pres., Radio-Electronics Div.,
COYNE ELECTRICAL SCHOOL
500 S. Paulina St., Dept. 25-1A,
Chicago 12, Ill.

Dear Mr. Lewis: Send me your Big Free Radio - Electronics Book and all the facts . . . also full details of your "Pay-after-Graduation" plan.

NAME.....

ADDRESS.....

CITY.....ZONE....STATE.....

"Learn by Doing"

RIGHT HERE in the SHOPS of COYNE-12 Weeks Training

I'll Finance Your Training

We train you on real Radio, Television and Sound equipment. Whether or not you have had Radio experience you need Coyne all-around Radio-Electronics training. We give you — RIGHT HERE IN THE COYNE SHOPS IN CHICAGO — the actual practice and experience you'll need in this great field. And because we cut out all useless theory and only give that which is necessary you get a practical training in a few weeks. Right now I'm including extra training in Industrial Electronics at no extra cost.

PREPARE FOR JOBS LIKE THESE

Frequency Modulation (FM)
Radio Manufacturing
Radio Set Serviceman
Television Servicing
Electronics Maintenance
Public Address Systems, etc.

**EXTRA
COURSE**
NO EXTRA COST

Industrial Electronics
Special extra course to help you get ready for the better jobs in this new wonder field . . . no additional tuition cost IF YOU ACT NOW!

EARN WHILE LEARNING

If you need part-time work to help pay living expenses while at school, we will help you get it. After you graduate, life-time employment service will be available to you. Every Coyne graduate also receives a Life Membership, with free technical and business service and privilege of review at any time without additional tuition charge.

THE HOME OF
COYNE



We have facilities for men with physical disabilities. If you have a physical disability of any kind write me when you send the coupon.

H. C. Lewis, Pres.

Founded 1899

COYNE ELECTRICAL SCHOOL
RADIO-ELECTRONICS DIV.

500 So. Paulina Street Dept. 25-1K CHICAGO 12, ILLINOIS

for Parts

Ten thousand different
radio and electronic parts
immediately available
on priorities.

for Service

Trained expeditors select
and ship, same day your
order is received.

for Experience

Known since 1922 for the
high character of our
policies and practices—as
jobbers, wholesalers and
manufacturers.

CONTACT

Radio Wire Television Inc.

100 SIXTH AVE., DEPT. R-1, NEW YORK 13, N. Y.
BOSTON, MASS. • NEWARK, N. J.

WORLD'S LARGEST
RADIO SUPPLY HOUSE

Originators and
Peacetime Marketers
of the celebrated

Lafayette Radio

Write today for our bargain flyers
and special bulletins.

tified by checking with a small battery-operated loop-antenna type receiver (or one equipped with a short antenna). With its aid the place where the interfering frequencies are being produced often may be determined.

If the source of the trouble cannot be isolated easily, the procedure to follow is to eliminate any rectifying elements or contacts and also to remove all r.f. potentials from the power lines of the house. The first step is to eliminate all poor contacts and joints which may be present in the antenna and ground circuits. These connections should be clean and preferably soldered. If the cross-modulation still persists, one or more of the following remedies probably will clear up the situation:

- (1) See that the power line and telephone line grounds are secure.
- (2) Ground the neutral of the house wiring at the house, in addition to retaining the ground at the distribution transformer.
- (3) Ground all conduits solidly.
- (4) Use an improved ground at the receiver.
- (5) Install an r.f. by-pass condenser from each side of the power line to ground at the point where it enters the house, near the receiver, or in both places.
- (6) In some cases, it is necessary to install r.f. chokes in the line, as well as the by-pass condensers.
- (7) Relocate the antenna so that there is less pickup from the power line to the antenna or leadin. Use a shielded leadin or an effective type of noise-reducing antenna where necessary.
- (8) Orient loop antenna for minimum pickup from the interfering station or stations.

Same-Channel Station Beat Interference

In areas remote from a usable assortment of strong stations, or wherever signals of two stations on the same channel are received at comparable strength, a flutter, waver, or growl due to one of the stations may be heard in the background when tuned to the other. This is due to the slightly differing carrier frequency of the undesired received station signal. Receivers having high sensitivity and extended bass response are especially susceptible to such interference.

Remedies for this type of interference lie in the use of a directive or loop antenna aimed so the interfering station is received with minimum strength; reduction of the sensitivity of the receiver; or reduction of the bass response.

Adjacent-Channel Station Beat Interference

In localities where a received adjacent-channel station signal is strong

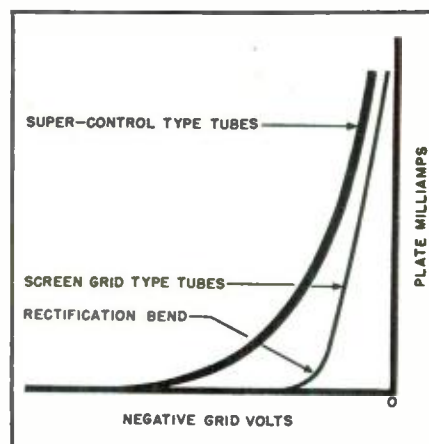

Fig. 5. Super-control-type tubes have an operating characteristic that permits wide input voltage swing with little detection, thereby reducing cross-modulation effects. Screen-grid-type tubes cause cross modulation on strong signals when they are used in the early r.f. stages of either t.r.f. or superheterodyne receivers.

compared to that of the desired station, a steady 10,000 cycle note or "whistle" will be heard due to the carrier of the adjacent-channel station (which is 10 kc. removed from that of the desired station) beating with the carrier to which the receiver is tuned. This type of interference can occur both in t.r.f. and superhet receivers—especially those having limited selectivity and wide range of audio response. Remedies for this type of interference lie in:

- (1) Careful realignment of the receiver tuned circuits—especially those of the i.f. amplifier, for it is in this part of the receiver that most of the adjacent-channel selectivity is obtained.
- (2) Suppression of the adjacent-channel interfering signal by means of a sharply-tuned antenna-circuit wave trap.
- (3) Reduction of the high-frequency response of the audio system.
- (4) Use of a directive or loop antenna so aimed as to reduce the strength of the received interfering signal.

Monkey-Chatter

In localities where the signals of adjacent-channel stations are strong, or where these stations employ higher-frequency-response transmitters, t.r.f. or superhet receivers having wide-band selectivity and audio response (high-fidelity receivers) may be troubled by unintelligible modulation superimposed upon the signal of the desired station, this modulation having the character of "inverted speech" sounding like "monkey chatter."

Let us see what causes this. When two received signals occupy adjacent channels, with a carrier-frequency separation of 10 kc., the extreme side-band frequency of one station is very close to that of the adjacent-channel station. If either station is modulating more than 5 kc. of audio range, the two side-bands will over-

BACK AGAIN...SOON

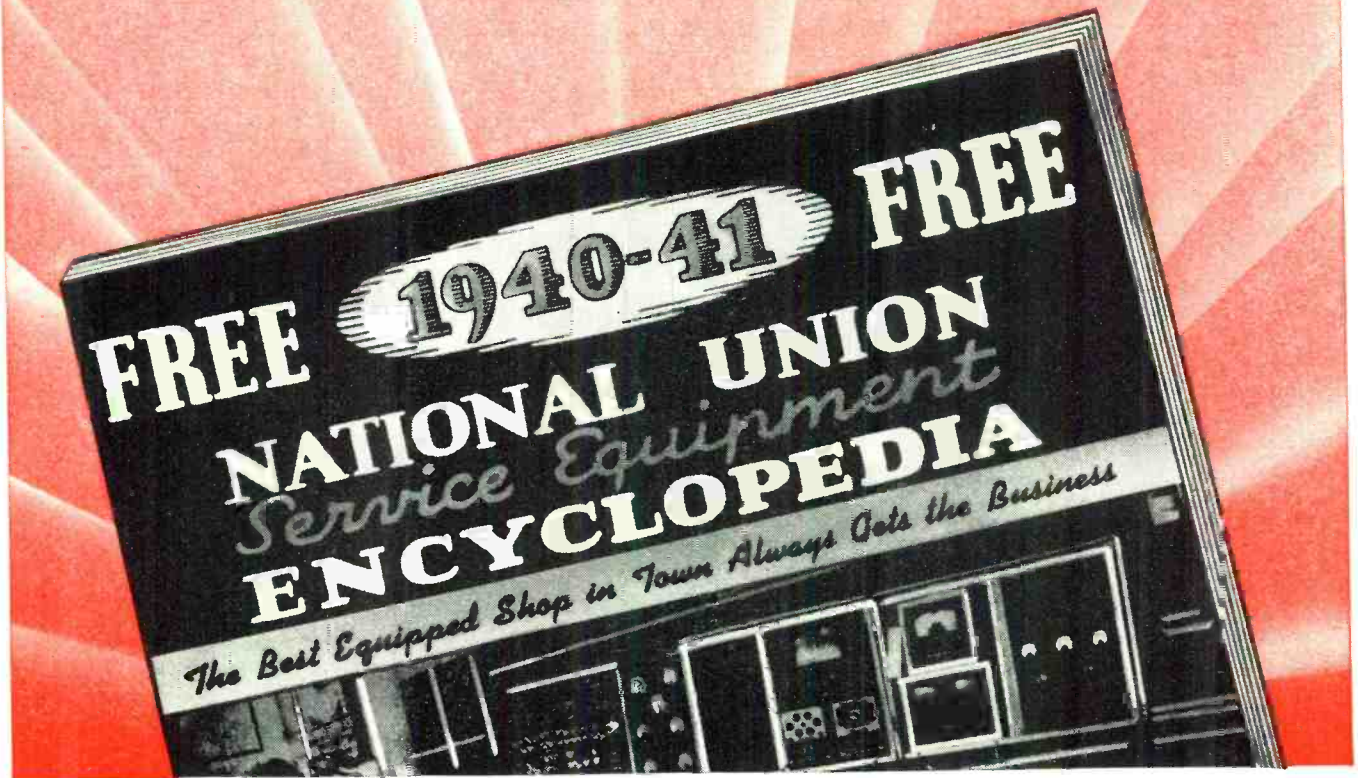

The Plan THAT GAVE 60,000 PIECES OF FINE TEST EQUIPMENT TO RADIO SERVICE DEALERS

Sure, you remember this big National Union Encyclopedia that showed all kinds of high-grade service and test equipment. It told you how to get the instruments and meters you wanted *free* with the exclusive N. U. Equipment Plan. And that plan was so popular that it was OK'd 60,000 times by radio service dealers!

AFTER THE WAR - MORE THAN BEFORE
Yes, a bigger and better Encyclopedia. More deals to bring you the modern test equipment you'll need to service radios, radio-phono-

graphs, television receivers and industrial electronic devices. After Victory, we'll make it easier than ever for you to equip your shop for more business and bigger profits . . . the exclusive National Union way!

NATIONAL UNION RADIO CORPORATION
NEWARK 2, NEW JERSEY
Dept. B

Factories at:
Newark and Maplewood, N. J.;
Landsdale and Robesonia, Pa.

NATIONAL UNION RADIO AND ELECTRONIC TUBES

Transmitting • Cathode Ray • Receiving • Special Purpose Tubes • Condensers • Volume Controls • Photo Electric Cells • Panel Lamps • Flashlight Bulbs



4 WAYS To Be Your Own Boss!

NOW, more than ever before, is the **right** time to start a small profitable business of your own . . . or train yourself for a practical money-making trade in which you can be **independent**. TODAY take your first step, without cost or obligation. Just mail coupon—and by return mail you will get full information on the courses listed here.

watch and clock repairing



LEARN AT HOME... IN YOUR SPARE TIME. Prepare for a happy future of prosperity, security . . . and get a big-pay job now. You can **EARN WHILE YOU LEARN**. Excellent field for part time work at home.

PRACTICAL COURSE IN HOROLOGY

Thorough self-instruction training in American & Swiss watches, clocks. Special sections on alarm clock repairs. Interesting **LEARN-BY-DOING** instruction method. Learn **QUICKLY**, easily. No previous experience necessary. **WATCH-MAKING IS BASIC TRAINING FOR AIRCRAFT INSTRUMENT WORK** and other scientific precision jobs.

Amazing Low Price! Money-Back Guarantee! Get into this fast-growing field now . . . big opportunity. Mail coupon below for **FREE** information. No obligation.

locksmithing and key making

Practical Up-To-Date Course

How to pick locks, de-code, make master-keys, repair, install, service, etc. New self-instruction lessons for every handy man, homeowner, carpenter, mechanic, service station, fix-it shop, hardware dealer or gunsmith.

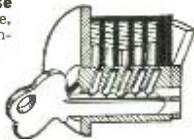

35 Easy Illustrated Lessons—Low Price! Satisfaction guaranteed or your money back. Write now no obligation!

practical RADIO servicing



SELF-INSTRUCTION COURSE

Teaches you the **practical** side of radio . . . repair, adjustment, operation, alteration, trouble-shooting. No previous knowledge is necessary. Large clear illustrations, diagrams, charts, etc.

Interesting STEADY WORK

—Set up a radio repair shop of your own—or prepare for booming industrial electronics. This useful, how-to-do-it course brings you all the fundamentals, including mathematics,

review questions, problems, answers. Strictly up-to-date. Low price. Send Coupon below for information!

MAIL ORDER BUSINESS

Your Big Opportunity!

34 lesson course on proved, tested, up-to-date **profitable** methods. Amazing treasure-house of the best mail order plans & practices. How to start your mail order business on a small one-man scale . . . how to keep it growing more and more profitable month after month. Money-making **FACTS! WRITE FOR COMPLETE DETAILS ON ANY OF THESE COURSES. Just send Coupon for World-Famous Copy-righted Success-Catalog—IT'S FREE! Write today.**

Nelson Co., Dept. 8859, 321 S. Wabash Ave., Chicago 4, Ill.

FREE details . . . mail coupon!

Nelson Co., Dept. 8859, 321 S. Wabash Ave, Chicago 4, Ill.—Please send me—FREE and without obligation—illustrated Success-Catalog containing information about the course (or courses) I have checked below. No salesman will call.

Watch & Clock Repairing Practical Radio Servicing
 Locksmithing, Key Making Mail Order Business

NAME.....
 ADDRESS.....
 CITY.....STATE.....

lap. In such a situation, if the side-band of one signal enters the second detector stage along with the side-band and carrier of the other signal (as will be the case in a high-fidelity receiver operating with its full broad-tuning and audio response, allowing a passage of frequencies $7\frac{1}{2}$ kc. on each side of the carrier—a total band of 15 kc. width), a peculiar combination of frequencies will result. The most troublesome frequency formed by this combination is that which is produced by the *difference* between 10 kc. and the modulation frequency involved. For example, in the case where a 3000-cycle note is modulating the adjacent undesired channel, it will produce an interfering side-band which will be superimposed upon the desired signal as a 7000-cycle note. That is to say, the side bands of the adjacent-channel station form a *difference* beat against the carrier of the desired station, or the one to which the receiver is tuned. This beat will be in the audible range and will have the character of "inverted speech." This means that a low-frequency modulation on the interfering station signal will create an audible signal of 10 kc. *minus* this frequency, or a resultant high frequency. High-frequency modulation, conversely, produces a low-frequency audio signal.

Since this interference is therefore an inversion of the adjacent-channel modulation, it appears as an unintelligible mixture, commonly termed "monkey chatter." Receiver selectivity discriminates against this type of interference. It is also limited by proper restriction of the high-frequency audio response. The selectivity ahead of the second detector is, of course, the principal factor in preventing response to the adjacent-channel signal modulation.

Most limited-fidelity receivers automatically suppress the 10,000-cycle beat from adjacent carriers because of their high degree of selectivity, or by the customary design of their audio amplifier or loudspeaker to have sufficiently limited upper-audio frequency response to prevent reproduction of such a high-frequency note. In "high-fidelity" receivers the situation is somewhat different. If the high-fidelity receiver is designed to cover an audio range up to say 7,500 cycles, a total band of frequencies 15,000 cycles wide must be passed by the i.f. amplifier. Under these conditions, the i.f. tuning must be so broad that it is almost a certainty that a filter will be required *after* the i.f. amplifier to eliminate the 10-kc. beat note caused by interference by carriers on adjacent channels, since the i.f. amplifier will not discriminate against these carriers enough to suppress them sufficiently when the full high-fidelity i.f. band width is employed. Therefore, the 10-kc. beat note must be prevented from reaching the loudspeaker. This is commonly accomplished by means of a suitable low-pass audio filter which cuts off sharply at around

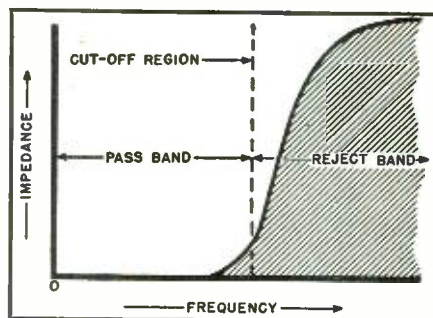

Fig. 6. Frequency-response characteristic of the audio filter circuit shown in Fig. 4. Note that it is a low-pass filter, passing all frequencies up to cutoff and offering a much higher impedance to all frequencies above this value.

7,500 or 8,000 cycles. This filter is located in the audio amplifier.

The details of such a filter arrangement, as used in the Philco 200-Series high-fidelity receivers, are shown in Fig. 4. The filter consists of an anti-resonant circuit composed of L and C (resonant at 10-kc.) connected in series with the circuit between the 75 second detector and the 42 driver tube. Two condensers C_1 and C_2 act as shunt arms. Since the filter works out of the plate circuit of the 75 second-detector tube, it is terminated in a resistor R_1 and a low impedance audio frequency bypass condenser C_3 . The frequency characteristic of a filter of this type is essentially as shown in Fig. 6. It presents a very-low impedance to the passage of all currents up to the cutoff frequency (about 7,500 cycles in this case). At this frequency the response cuts off sharply so that all currents of higher frequency than this meet with a high opposition and are greatly attenuated. In this way, the 10-kc. beat note from interfering adjacent-channel stations is effectively prevented from getting through the audio amplifier and reaching the loudspeaker. This particular filter has a discrimination of about 25 db. at 10-kc. The condenser C is made adjustable to allow for the various conditions of interference that might arise from adjacent-channel stations in different localities.

Another very effective method of accomplishing the same end is through the use of a tertiary circuit, consisting of a parallel-tuned coil associated with the loudspeaker matching transformer. This coil is tuned to a frequency slightly below 10,000 cycles and gives a sharply defined attenuation and cutoff of the higher audio frequencies.

High-fidelity receivers usually contain a control for the high-frequency end of the audio band, and also a control for reduction of selectivity, which makes possible two degrees of fidelity. Where interference from an adjacent channel beat note exists, this control may be reduced to effect its elimination.

When "monkey-chatter" is encountered in an existing receiver, there are two methods of treatment:

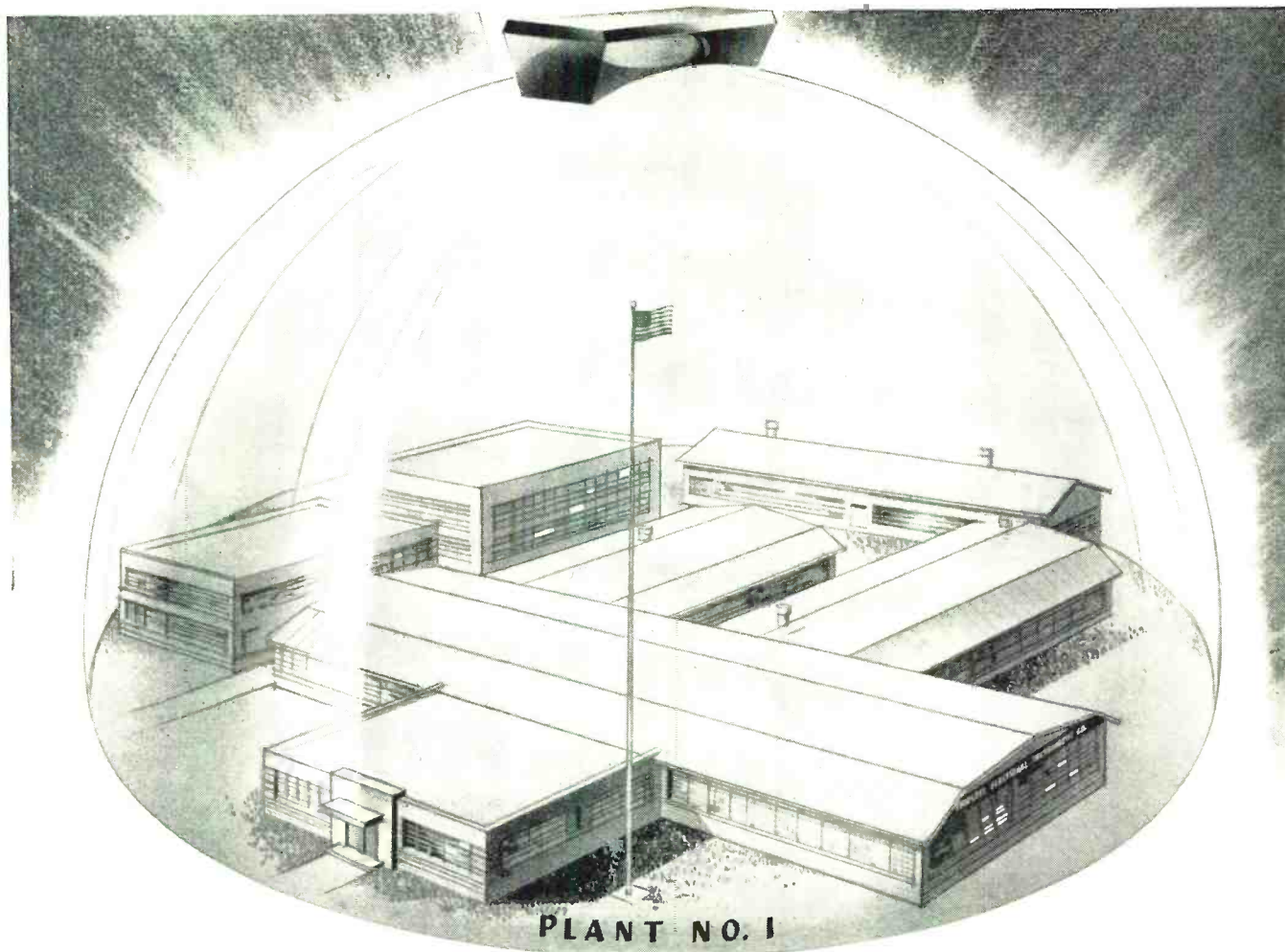

" DUSTLESSTOWN, OHIO "

● It's the little things that loom biggest in the manufacture of delicate electrical measuring instruments. Little things like specks of dust or breath condensation can play havoc with accuracy. That's why Triplett Instruments are made in spotless manufacturing departments; why the air is washed clean, de-humidified and

temperature-controlled; why every step in their mass production is protected. As a result Triplett Instruments perform better, last longer and render greater service value.

Extra Care in our work puts Extra Value in your Triplett Instrument.



Triplett

ELECTRICAL INSTRUMENT CO. BLUFFTON, OHIO

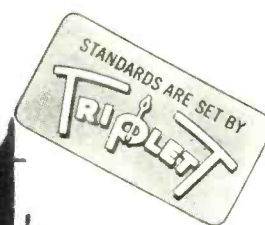

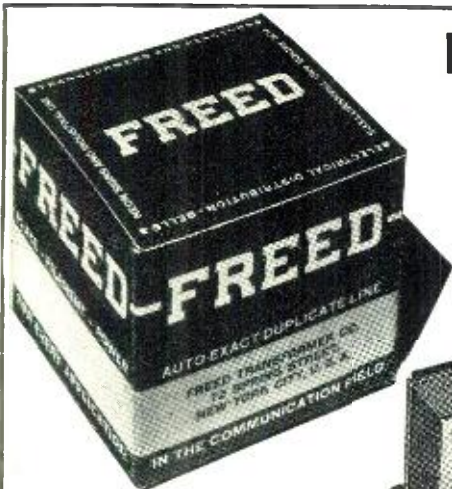

Packaged Superiority

In every Freed package is a transformer that guarantees maximum performance, that meets all your service requirements.

EACH package contains a transformer of marked superiority which has passed rigid inspections. The Freed line contains all types of transformers: power, interstage, isolation, step-down, band pass filters and reactors. Available in sizes for all requirements and made to exacting specifications for continuous per-

formance at specified frequencies. Installation is simplified by mounting centers die-stamped to precision accuracy. To give the best service, use the transformers of performance. Use Freed!

Send in your name now and we will reserve a copy of the latest Freed catalogue for you.

FREED TRANSFORMER CO.
74 SPRING ST., NEW YORK, N. Y.

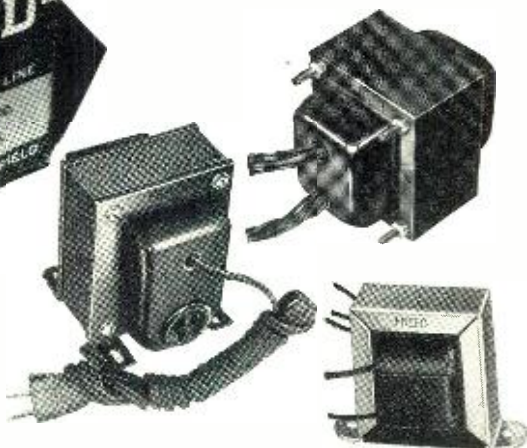

- (1) Suppression of the adjacent-channel interfering signal either by precisely aligning the receiver to make it more selective, or by adding a sharply-tuned wave trap (or pair of them) to the antenna circuit.
- (2) Reducing the high-frequency response of the audio system of the receiver.

In general, "monkey-chatter" interference will be more prevalent at more points on the tuning scale in localities where the number of popular stations is limited, and where such stations are at relatively great distances.

Overmodulation of the adjacent channel station accentuates the interference due to "monkey-chatter" because of the higher frequency sidebands which are generated by such overmodulation. Overmodulation however, is an unusual condition and usually should not be suspected as the most likely cause for this type of interference.

Summary of Reasons for Including a T.R.F. Amplifier in the Superheterodyne Receiver

The principal purpose of including the t.r.f. amplifier in a superheterodyne receiver is mainly to provide sufficient selectivity ahead of the mixer to effectively preselect the desired signal and suppress "image" and several other types of interfering frequencies before they reach the mixer. The r.f. amplifier is *not* used primarily to obtain adjacent-channel selectivity, for the i.f. amplifier provides most of that. Its main function is to prevent signals 20 or more kilocycles removed from the desired signal frequency from causing the various types of spurious interferences we recently have been studying.

It also serves to isolate the local-oscillator circuits from the antenna circuit, thereby reducing interference caused by oscillator radiation. A single high-gain stage of sharply-tuned t.r.f. amplification is generally sufficient for these purposes. The selectivity and sensitivity of the superheterodyne can be increased greatly, however, by the use of two stages of t.r.f. amplification when it is permissible, and at the same time the signal-to-noise ratio is appreciably increased thereby. The mixer or frequency-converter stage usually introduces more noise than an r.f. stage of amplification. This noise is amplified, together with the desired signal, by the i.f. amplifier; therefore, if the signal strength is increased *before* mixing, less amplification is required in the i.f. amplifier and a greater signal-to-noise ratio is obtained. Since there also is some noise inherent in the r.f. amplifier, the amount of amplification before mixing will be limited by the noise present in the first r.f. stage.

Super-control r.f. pentode type tubes are used in the r.f. stages of practically all modern superheterodynes, as such tubes ordinarily are not subject to cross-modulation effects, do not re-

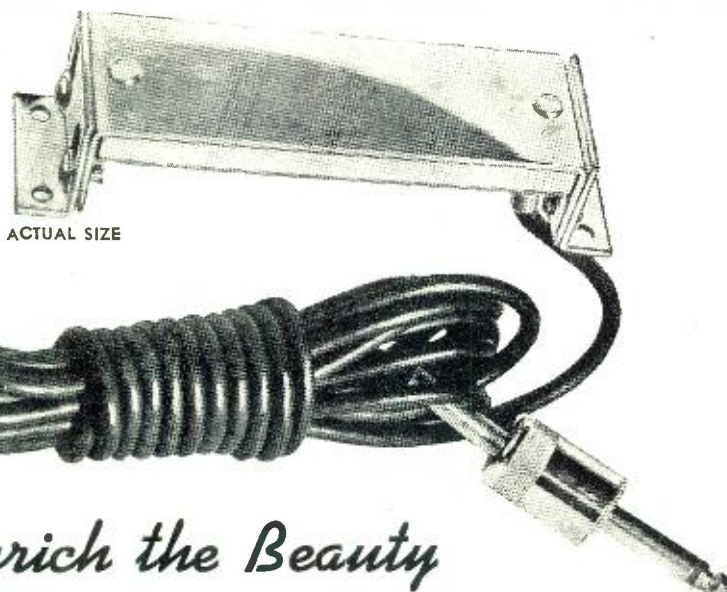

Enrich the Beauty

of your Mandolins, Spanish or Hawaiian Guitars, and similar string instruments with an easy-to-attach UNIVERSAL MAGNETIC PICKUP. Can be adjusted to any string height.

We also manufacture all types of coils. Just send us your specifications, and we will be pleased to quote prices.

LECTROLAB PRODUCTS

Manufacturers and Designers of Electronic Devices

2806-10 W. HARRISON STREET • CHICAGO 12, ILLINOIS



The Greeks gave us a word for it . . . now we give it to *you*

WHEN Sperry first developed its velocity-modulated, ultra-high-frequency tube, the word "KLYSTRON" was registered as the name of the new device.

This name — from the Greek, as coined by scientists of Stanford University — is an apt description of the bunching of electrons between spaced grids within the tube.

"Klystron" is a good name. So good, that it has come into widespread use as the handy way to designate *any* tube of its general type,

whether a Sperry product or not.

This is perfectly understandable. For the technical description of a Klystron-type tube is unwieldy, whether in written specifications, in conversation, or in instructing members of the Armed Forces in the operation of devices employing such tubes.

These conditions have prompted many requests from standardization agencies—including those of the Army and Navy—for unrestricted use of the name Klystron. In the public interest, Sperry has been glad to

comply with these requests . . .

From now on, the name KLYSTRON belongs to the public, and may be used by anyone as the designation for velocity-modulated tubes of any manufacture.

Sperry will, of course, continue to make the many types of Klystrons it now produces, and to develop new ones.

On request, information about Klystrons will be sent, subject to military restrictions.

SPERRY GYROSCOPE COMPANY, INC. GREAT NECK, N. Y.

Division of the Sperry Corporation

★
LOS ANGELES • SAN FRANCISCO • NEW ORLEANS
HONOLULU • CLEVELAND • SEATTLE

GYROSCOPICS • ELECTRONICS • RADAR • AUTOMATIC COMPUTATION • SERVO-MECHANISMS

RADIO PARTS FOR IMMEDIATE DELIVERY

We carry a complete supply of all types of radio parts and electronic equipment.

MICROPHONES TURNER . . . CRYSTALS

Model	List	Your Cost
BX	\$ 9.95	\$ 5.85
CX	15.00	8.82
22X	18.50	10.88
33X	21.00	12.35
34X	25.50	14.99



TURNER DYNAMIC HI IMPEDANCE

22D	\$23.50	\$13.82
33D	23.50	13.82
88	30.50	17.93
99	33.00	19.41
211	45.00	26.46

ASTATIC

JT30	\$15.50	\$9.11
------	---------	--------

(Complete with table stand)

CABINETS

11"x8"x5 1/2"
Available in bleached or natural wood
\$2.75 each; 10 for \$25.00.



10 for \$32.50-
14 3/4" x
8 1/2" x
8 1/2"

\$350 each

CHASSES

Blank
8" x 5" x 1 1/2"
With Four Holes,
8" x 4" x 1 1/2"
8" x 5" x 1 1/2"
With Five Holes
9" x 6" x 1 1/2"
10" x 5" x 1 1/2"

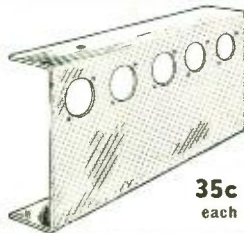

35c each

FULL LINE OF SPEAKERS

BARGAIN SPECIAL AUTO AERIALS

Three section—66" long—side cowl mount—complete with shielded lead; 30 to a case.
Each...\$2.95—In Lots of 10 or more...\$2.50 each

Write for our latest catalog
All foreign orders payable in U. S. funds

RADIO PARTS COMPANY

612 W. RANDOLPH ST.
CHICAGO 6, ILLINOIS

quire neutralization, and provide high voltage gain.

The performance of a superheterodyne receiver is in a large measure dependent upon the design of its r.f. and i.f. stages. If the r.f. stages do not provide the necessary preselection and off-channel selectivity, at least some of the many types of spurious interfering responses that we have studied in the preceding few lessons will occur and hopelessly spoil the reception.

(To be continued)

The Television Channel

(Continued from page 46)

shown on the figure (vertical sweep). Consequently, each horizontal line begins slightly below the previous one, the beam gradually making horizontal traces down the screen under the pull of the much slower moving vertical sweep. We also can notice from Fig. 3 that the vertical seems to have more pull during the horizontal trace than during the retrace. This is accountable because the horizontal trace is slower than the retrace.

Interlaced Scanning

The scanning of the horizontal lines is not performed in sequence (1, 2, 3, etc.) but instead the odd-numbered lines are scanned first (1, 3, 5, 7, etc.) and then the beam returns and scans the even-numbered lines (2, 4, 6, 8, etc.). This method is called interlaced scanning and is shown in Fig. 6. Scanning begins at line number 1 at the top left of the screen, or scanning raster, and proceeds to the right; at this point, the beam retraces to the left and begins scanning the third line. The scanning cycle continues until the beam reaches the lower right-hand corner of the raster. Here the vertical retrace returns the beam to the top center of the scanning raster and the scanning of the even-numbered lines begins. When the last line is scanned, ending at the bottom center of the scanning raster, the beam is returned to the top left and initiates the start of a new frame. Each frame or one complete picture consists of 525 lines and to simulate motion 30 frames or complete pictures are scanned each second. However, because of the interlaced sys-

tem there are 60 vertical sweep cycles or fields per second as first the odd-numbered lines and then the even-numbered lines are scanned. Since each frame or picture is constructed of both odd-numbered and even-numbered lines each frame consists of two fields.

Although each frame consists of 525 horizontal lines only approximately 485 of these lines actually carry picture or video signal; the remainder of the horizontal lines are lost during the vertical retrace intervals (there are two vertical retrace intervals for each frame—one between fields the other between frames). The vertical retrace interval lasts for approximately 1250 microseconds twice each frame, and consumes approximately 40 horizontal lines. Thus, the beam is not returned directly from bottom to top, as shown in Fig. 6, but returns over a path similar to that shown in Fig. 2—there being quite a number of horizontal sweeps during the vertical retrace.

It is evident a considerable amount of time is consumed in retracing the beam, and for these intervals no picture information is transmitted. Furthermore, it is necessary to blank out or cut off the electron beam during these intervals to prevent visible retrace lines from streaking across the picture on the screen. In fact the only time the electron gun emits a strong beam and the only time useful picture information is transmitted is during the traces from left to right of the 485 active lines. During the retrace intervals, both horizontal and vertical, the electron gun cuts off the beam and no picture information is conveyed from transmitter to receiver.

Construction of Television Signal

Three types of information are transmitted on the picture carrier: (1) picture or video signal, a progressive series of electrical impulses which represent the relative light values of the object televised; (2) sync, a series of rectangular pulses which keep the cathode-ray beams at transmitter and receiver in synchronism; and (3) blanking, a series of rectangular pulses, which blank or blackout the fluorescent screen during all retrace intervals.

(1) The video signal is formed when

Table 1. Technical data on the first three television channels.

Channel	Low-Freq. End of Channel	Guard Band	Flat Portion Low-Freq. Sideband	Picture Carrier Frequency	Flat Portion High-Freq. Sideband	Guard Band	Sound Carrier Frequency	High-Freq. End of Channel
1	50 MC	50 to 50.5	50.5-51.25	51.25	51.25-55.25	55.25-55.75	55.75	56
2	60	60 to 60.5	60.5-61.25	61.25	61.25-65.25	65.25-65.75	65.75	66
3	66	66 to 66.5	66.5-67.25	67.25	67.25-71.25	71.25-71.75	71.75	72

when silence is golden *



C-D capacitors are precision products.

Every operation in their processing is subject to careful checking and re-checking. Specialists in capacitor manufacture dictate the proper tests, the value of the tests and their sequence in the manufacturing process.

Such precise attention to detail brings its reward in the reputation C-D capacitors have for quality and performance. We are maintaining that reputation . . .

PROOF: *More engineers choose C-D than any other make.*

Today our special skills are focussed on the capacitor problems of the nation and of industry. Our enormously enlarged facilities may be able to help you. Cornell-Dubilier Electric Corporation, South Plainfield, N. J. Other plants: New Bedford, Brookline, Worcester, Mass., and Providence, R. I.

*This reliable bridge balancing test for checking capacity and power factor is one of the many, many tests used at C-D during the course of production. If the bridge is not in balance, capacity of unit being checked is off, and a hum is heard by tester. When capacity is correct she hears no signal.

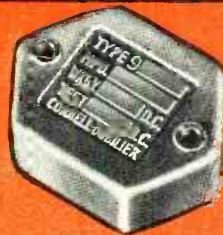

HERE'S A FAMOUS C-D MICA CAPACITOR — THE TYPE 9 FOR R. F., BY-PASS, GRID AND PLATE BLOCKING IN LOW POWER TRANSMITTERS AND AMPLIFIERS.

Special impregnation resists changes in capacity with high insulation resistance.

No magnetic material reduces losses at all frequencies.

Moulded in Bakelite for greater mechanical strength and better insulation.

Short, heavy terminals for minimum r.f. and contact resistance. Typical of C-D's precision engineering.

CORNELL - DUBILIER
CAPACITORS 1910  1944

MICA • DYKANOL • PAPER • WET AND DRY ELECTROLYTICS

MAKE CHASSIS and PANEL HOLE CUTTING EASY

CUT ANY SIZE HOLE IN

5/8" to 1 1/2" WITH ONE

Sheet Metal
Dural
Plastics
Wood
Plywood
Masanite
Hard Rubber
or Fibre

BRUNO Adjustable HOLE CUTTER

ONLY **2.95**

Nothing like Bruno Adjustable Hole Cutters for radio servicemen, technicians, experimenters, amateurs. A single Bruno Hole Cutter does the work of many fixed-radius cutting tools—slashes tool costs.

For Holes 1" to 2 1/2" **4.95**
Use Bruno No. 101

Cutting range of Bruno No. 100 is from 5/8" to 1 1/2" — furnished with 1/4" straight shank; or with bit stock for braces (Bruno No. 100-B). Cutting range of Bruno No. 101 is from 1" to 2 1/2" — with 3/8" straight shank. Also furnished as No. 101-B, with bit stock for braces. High speed cutting blade can be sharpened with a pocket hone.

Ideal for electric drills and light drill presses.

Cut deep holes in wood or compressed material.

No trick to set and re-set adjustable cutting blade.

All Bruno models cut clean holes in plastics, fibre, hard rubber, sheet metal and other materials. Ideal for practical all 'round radio work — saves time and money.

ORDER TODAY FROM YOUR RADIO JOBBER OR DISTRIBUTOR

He Can Get Bruno For You Immediately!

JOBBER Inquiries invited for these "repeat-order" cutters — selling fast wherever stocked. Colorful counter display free with minimum order. Assortment No. 2200 ready for shipment. Write Dept. RN-2.

BRUNO TOOLS
9330 Santa Monica Boulevard
Beverly Hills, California

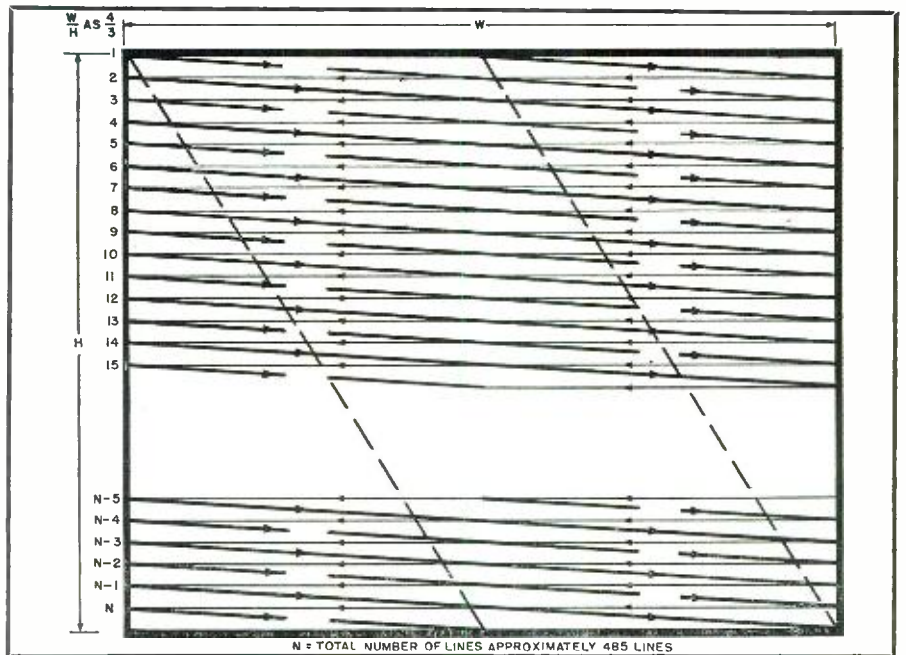

Fig. 6. Procedure of scanning the horizontal lines. The odd-numbered lines, that is, 1, 3, 5, etc., are scanned first and then the beam returns and scans the even-numbered lines, that is, 2, 4, 6, etc. This method is termed interlaced scanning.

the electron beam of the pickup tube moves from left to right across the mosaic, releasing electrical charges in accordance with the intensity of the light focused on the various points scanned. One complete frame or picture is transmitted in 1/30th of a second and one complete line is transmitted in 53 microseconds. Now let us assume a dark black spot on the mosaic represents peak signal amplitude and an intense bright spot, minimum signal amplitude. Thus, a gradual change in light intensity from white to black and back again to white as the beam scans one horizontal line, can be assumed to represent one cycle. Since one horizontal scan from left to right occurs in 53 microseconds the base frequency of this one cycle is $1/53 \times 10^{-6}$ or 18,870 cycles per second. What is meant is that a frequency response of 18,870 cycles would be required to pass this very gradual change in light value, at the high velocity with which the beam scans. However, a very much greater response is necessary to make a more abrupt change from light to dark or dark to light. It is possible to have a change from white to black and back to white occur in .025 inches in the case of a thin black vertical line on a five-inch screen. For the five-inch tube the beam travels the horizontal trace in 53 microseconds and, therefore, travels one inch in 10.6 microseconds, and the number of microseconds required to travel .025 inches is, consequently, $.025 \times 10.6$ or .265 microseconds. Thus one cycle which occurs in .265 microseconds is equivalent to a base frequency of $1/.265 \times 10^{-6}$ or 3.77 megacycles per second. It is apparent from the above figure how necessary it is to use wide-band amplifiers and broad channels, to convey a picture with clarity and definition from transmitter to receiver.

The video signal and its position in the composite signal is shown in Fig. 4 and again in Fig. 5. In conclusion the video signal is transmitted point-after-point and line-by-line and is only interrupted for the horizontal and vertical blanking (retrace) intervals.

(2) The horizontal sync pulses, of which there are 525 each frame, keep the horizontal motion of the receiving tube scanning beam in synchronism (or "in sync") with the same motion of the pickup tube beam. Therefore, at any one instant, the two beams are striking their respective scanning rasters at the same relative position. These "sync pulses," thus, hold the picture stationary horizontally (prevent tearing out). A typical sync pulse, as shown in Fig. 4A, has a duration of approximately 5.08 microseconds, and initiates the horizontal retrace at the receiver by regulating the generation of the horizontal sawtooth sweep. For a short interval before the transmission of the sync pulse a blanking pulse is transmitted, Fig. 4B, which immediately blacks out the screen. This blanking signal continues for an interval after the sync pulse, permitting sufficient time for the beam to return to the left side of the screen before the screen is unblanked—the total blanking interval has a duration of 10.16 microseconds.

The actual television signal which appears on the control grid of the picture tube, as shown in Fig. 4C, has a negative polarity—that is, the more signal amplitude applied the further negative the grid is driven and the darker the fluorescent screen becomes. Consequently, when the picture signal is at minimum value the screen is brilliantly illuminated and when it reaches a maximum value there is a dark spot on the screen. After the completion of one horizontal line the grid is driven

Basic Design

makes the difference!

Smudge-voice

While these two columns read identically, word for word, the smudged column is a visual representation of an acoustical condition when background noise interferes with transmitted speech.

The words may be readable, but effort and concentration are required for accuracy. And so with reproduced sound: with general purpose microphones, articulation is lowered even though ambient noises do not completely override speech. The Electro-Voice Differential is specifically designed to erase interfering background noise. Speech is clean, clear, crisp . . . unadulterated by stray pickup or distracting background.

Electro-Voice

While these two columns read identically, word for word, the smudged column is a visual representation of an acoustical condition when background noise interferes with transmitted speech.

The words may be readable, but effort and concentration are required for accuracy. And so with reproduced sound: with general purpose microphones, articulation is lowered even though ambient noises do not completely override speech. The Electro-Voice Differential is specifically designed to erase interfering background noise. Speech is clean, clear, crisp . . . unadulterated by stray pickup or distracting background.



Electro-Voice DIFFERENTIAL MICROPHONES

Electro-Voice engineers have years of experience in the elimination of ambient noise. We designed and developed the now-famous "Lip-Mike," the first successful Differential microphone. Our new Model 205-S for aircraft, railroad, industrial and police applications is another Differential achievement. Soon there will be Electro-Voice Differential microphones for all communication services. Watch for them.

If any of your limited quantity needs can be met by standard model Electro-Voice microphones, with or without minor modifications, contact your local radio parts distributor.



BLOOD DONORS ARE URGENTLY NEEDED . . . SEE YOUR LOCAL RED CROSS

Electro-Voice MICROPHONES

ELECTRO-VOICE CORPORATION • 1239 SOUTH BEND AVENUE • SOUTH BEND 24, INDIANA

Export Division: 13 East 40th Street, New York 16, N. Y., U. S. A. Cables: Arlab



Look to the Leader for Leadership

Gothard NEON PILOT LIGHT

3000 Hour
Continuous Operation
Warm Glow
Visible from All Angles



The Ultimate in Light
Penetration and Diffusion

The Gothard Neon Lamp Pilot Light will burn continuously for approximately 3000 hours, as compared with the approximate 500 hour life of ordinary lamps. It operates on 100 volts and consumes only $\frac{1}{4}$ watt. The unbreakable lucite protective cap, designed and made for Gothard exclusively, provides perfect light dispersion of its warm neon glow in all directions. Lucite cap unscrews for lamp change. Bakelite socket. Polished and chrome plated jewel holder. 1" mounting hole. Colors—red, green, amber, blue and clear. Ask for complete information on this and wide range of other Gothard Lights.

Gothard

MANUFACTURING COMPANY
1350 North Ninth Street, Springfield, Illinois
EXPORT DIVISION—25 Warren Street
New York 7, N. Y.
CABLES—Simonrice, New York

FADA Permanent NEEDLES

List \$1.00

Special Introductory Offer 39¢

(TO DEALERS ONLY—IN LOTS OF 6 OR OVER)

- Plays 4M Records without changing
- Better Tone Reproduction
- Help Reduce Background Hiss
- Longer Record Life

FADA OF NEW YORK

928 BROADWAY NEW YORK 10 N. Y.

Large Stock of Replacement Parts and Cabinets

to cutoff by the blanking signal (point a) and the screen is blacked-out. A short time later the horizontal sync pulse is transmitted—the sync pulse swings the grid further negative (called the blacker than black region) still holding the screen blacked-out. The blanking signal continues for a short interval after the sync pulse, still holding the screen blacked-out and allowing the beam to retrace. At point b, the blanking signal is removed, the screen is unblanked, and a new horizontal line begins. Drawing (c) shows two horizontal lines and corresponding horizontal blanking intervals.

(3) The vertical sync pulse intervals, of which there are two each frame (interlaced scanning system), keep the vertical motion of the receiving picture tube scanning beam in sync with the same motion of the pickup tube beam. These vertical sync pulses hold the picture stationary vertically (prevents turning over). A typical vertical sync pulse, as shown in Fig. 7A, has a duration of 27.3 microseconds—actually, Fig. 7C, the vertical sync pulse interval consists of six 27.3 microsecond pulses. The brief interruption of the vertical pulses prevents the horizontal from losing synchronism during the vertical blanking intervals. Here again the vertical blanking drives the control grid of the picture tube to cutoff, blanking out the screen. During the vertical interval, and before and after the vertical sync pulse interval a series of short duration equalizing pulses are transmitted which equalize the vertical retrace intervals between frames and between fields (interlaced scanning system).

Television Facts and Figures

6 megacycle channel
525 lines—485 active lines and 40 inactive lines
interlaced scanning — 30 frames per second or 60 fields per second
15,750 lines per 30 frames
one frame—33,334 microseconds
one field—16,667 microseconds
one horizontal sweep cycle—63.5 microseconds
horizontal retrace or horizontal blanking interval — 10.16 microseconds
horizontal trace—53.34 microseconds
horizontal sync pulse—5.08 microseconds

vertical blanking interval — 1250 microseconds
vertical sync pulse interval—190.5 microseconds
vertical sync pulse—27.3 microseconds
equalizing pulse — 2.54 microseconds
4 to 3 aspect ratio

Summation

The contents of this article has covered in considerable detail the facts and figures on the standard television signal. It is difficult to understand and remember all the detailed information; consequently, a large portion of the most pertinent material is presented in chart form and to assist in retaining the signal construction detail. A step-by-step analysis of the standard signal is presented in connection with Fig. 5. As the various subjects are discussed individually in future installments the actual detail will become firmly established and no longer a process of memory. Until such time this installment should be held as a reference to which future installments will occasionally refer.

Refer to the Federal Communications Commission standard television signal (Fig. 5) and follow the signal sequence from the start of one frame to the start of the next.

1. Start of picture signal at top left hand corner of raster.
2. Picture or video signal for one line.
3. Horizontal blanking pulse at completion of first line. Blanks out screen to make retrace invisible.
4. Horizontal sync pulse which initiates the beam retrace—controls horizontal sweep circuits.
5. Horizontal blanking continues, to allow sufficient time for the beam to retrace.
6. Second line of video signal begins—actually this is No. 3 scanning line because of interlaced scanning system.
7. All the odd-numbered scanning lines are covered—consecutive odd-numbered lines interrupted by the horizontal blanking intervals.
8. Odd-numbered line scanning completed at bottom right hand corner of scanning raster. Only a few of the horizontal lines are shown on the drawings.
9. Vertical blanking pulse at completion of first field. Blanks out screen to make retrace invisible.

Fig. 7. (A) The vertical synchronizing pulse which holds the picture stationary, preventing turning over. (B) Transmitted pulse which equalizes the vertical retrace intervals between frames and between fields. (C) A succession of vertical synchronizing and equalizing pulses as they occur.

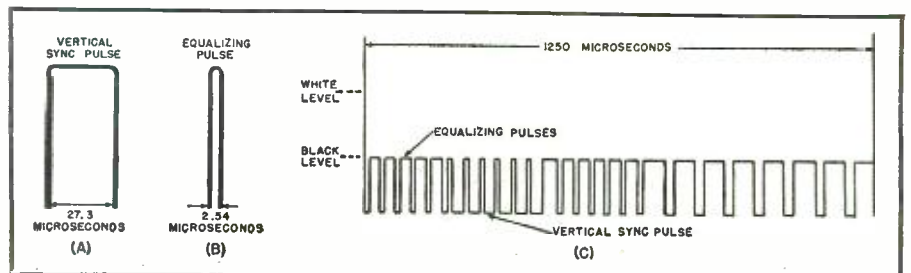



The Extra Quality

THAT GIVES CHAMPIONSHIP

PERFORMANCE

ANY horse can run a race, but only a thoroughbred wins consistently.

Where performance counts, Turner Microphones win top recognition in every field of electronic communications. On land, on sea and in the air — in education, business, entertainment and science, Turner applications deliver that EXTRA quality that is the measure of a thoroughbred.

Turner pioneers the communications

field with scientific engineering that reproduces only those vibrations received by the diaphragm without adding any of the harmonics. The full meanings of sound are delivered with their delicate gradations of tone and volume. A soft whisper or a shrill fortissimo come clear and crisp in the full focus of intelligibility.

Let Turner Microphones "spark" your electronic communications with life-like performance.

Crystals Licensed Under Patents of the Brush Development Company

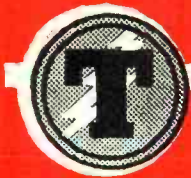

The **TURNER**
Company

CEDAR RAPIDS, IOWA



Write for
Free
CATALOG

TURNER—Pioneers in the Communications Field



TURNER 22



TURNER 211



TURNER HAN-D



TURNER 99

ELECTRICITY FOR RADIO AND ELECTRONIC APPLICATIONS

● ONAN ELECTRIC GENERATING PLANTS supply reliable, economical electric service for electronics applications as well as for scores of general uses.

Driven by Onan-built, 4-cycle gasoline engines, these power units are of single-unit, compact design and sturdy construction. Suitable for mobile, stationary or emergency service.

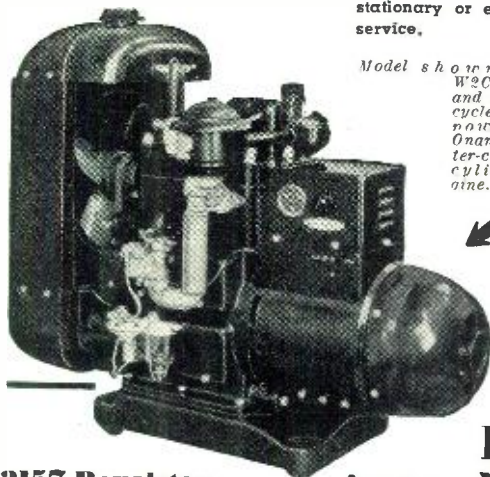

Model shown is from W2C series, 2 and 3-KW. 60-cycle, 115 volt; powered by Onan-built water-cooled 2-cylinder engine.



Models range from 350 to 35,000 watts. A.C. types from 115 to 660 volts; 50, 60, 180 cycles, single or three-phase; 400, 500 and 800 cycles, single phase; also special frequencies. D.C. types range from 6 to 4000 volts. Dual voltage types available. Write for engineering assistance or detailed literature.

Over 200,000 in service

2157 Royalston

Avenue

D. W. ONAN & SONS
MINNEAPOLIS 5. MINN.

SPEED UP REPAIRS WITH THESE G-C AIDS!

FREE
STEEL
CABINET



G-C Dial Belt Kits
Exact replacement woven fabric belts. Easy to install — no stretching — no adjustments — a perfect fit every time. Kits come with 25, 50, 100, 200 or 300 belts.



Automatic Wire Stripper
Strips insulation from all types of wire. Does the job instantly, easily, perfectly. An ideal tool for radio men, electricians and sound men.



G-C Contact Service Kit
Contains special contact cleaner and corrosion resistant lubricant. You can clean noisy controls nine times out of ten without dismantling chassis or control unit. Pays for itself over and over.

Order From Your Radio Parts Jobber
ALWAYS ASK FOR G-C PRODUCTS



GENERAL CEMENT MFG. CO.
ROCKFORD, ILLINOIS

GET THE IMPROVED SUPER DRILL GRINDER

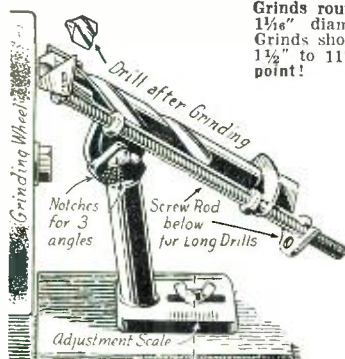

Grinds round shank drill points from No. 42 to 1 1/8" diameter. Grinds old drills like new. Grinds short, medium and long twist drills from 1 1/2" to 11". The grinder that gives a rounded point!

"Money Back Guarantee"
GRIND YOUR DRILLS LIKE FACTORY IN 25 SECONDS! Get a perfect center and clearance in three different drill point angles. NO MACHINE SHOP OR HOME WORK SHOP SHOULD BE WITHOUT THE SUPER DRILL GRINDER. Just mail your check or money order for only \$2.95, with your printed address — the SUPER GRINDER will come to you by return mail postage paid.

ONLY
\$2⁹⁵
COMPLETE!

A. D. McBURNEY
939 West 6th Street, Dept. MK-2
Los Angeles 14 California

The ideal tool for the hobbyist!
Available now — buy it today.

10. A series of six equalizing pulses.
11. Vertical sync pulse interval which initiates the beam retrace—controls vertical sweep circuits.
12. Series of six more equalizing pulses and continuation of blanking to allow sufficient time for beam retrace.
13. Horizontal pulses continue throughout vertical blanking interval to prevent loss of horizontal control during the vertical retrace.
14. Retrace returns beam from lower right-hand corner to top center of scanning raster.
15. Start of even-numbered scanning (second field) at top center of scanning raster.
16. First horizontal blanking interval of second field.
17. Even-numbered lines are scanned until picture information for the frame is completed at lower center of scanning raster.
18. Vertical retrace between frames begins.
19. Beam has returned from bottom center to top right of scanning raster, completing one frame.
20. Start of first scanning line of next frame.

-30-

Wacs at Work

(Continued from page 35)

sages throughout the teletypewriter-operated wire, cable, and radio networks without the necessity of manual retransmission. Wacs become proficient in the operation of all the apparatus used in the relay system.

Security of military communications is of first importance. The Wacs must be alert at all times to prevent valuable information from falling into the hands of the enemy. They must recognize messages which require censorship, and must see that the messages are censored.

Work done by the Wacs has assumed additional importance with the integration of the Army Communications Service's domestic wire and overseas radio networks into a flexible, uniform world-wide system.

Although many of them are new to their assignments, the Signal Center Wacs are doing an outstanding communications job. Brigadier General Frank E. Stoner, Chief, Army Communications Service, Office of the Chief Signal Officer, has this to say:

"Members of the Women's Army Corps are performing vital tasks in the War Department Signal Center, hub of the United States' world-wide communications system, where security, accuracy, and speed are of paramount importance. We have found the Wacs conscientious, efficient, and dependable in handling the messages of war. They have proved that they are thoroughly capable of filling many positions which formerly required trained men who thus have been released for service in the Theaters of Operations."

-30-

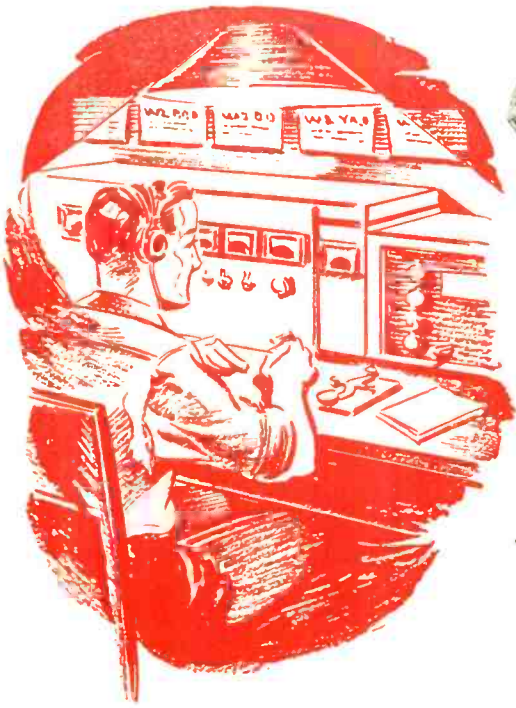

After ADOLPH and TOJO are **Q·R·T**

The rig he left behind is due for a big change when GI Joe comes home. War experience has been an "eye opener" for him. From chassis to sky wire many pre-war Ham outfits will undergo a major alteration and amazing technical advances will be put into practice. Stimulated by training and experience gained in the armed services thousands of new enthusiasts will swell the ranks of amateur radio.

When the gang goes back on the air again,

CQ'ing, SS or DX; UNITED will be ready to serve the Amateur with war-perfected Transmitting Tubes.

Since 1934 UNITED has specialized in engineering, designing and building Transmitting Tubes that set the Quality Standard for the entire Radio Industry. When performance counts UNITED Tubes provide a maximum of electronic efficiency—plus a long and dependable life. Accept nothing less than UNITED quality for your own tube requirements.

Order direct or from your electronic parts jobber.

MASTERPIECE OF SKILLED HANDS

UNITED

ELECTRONICS COMPANY

NEWARK, 2



NEW JERSEY

Transmitting Tubes **EXCLUSIVELY** Since 1934

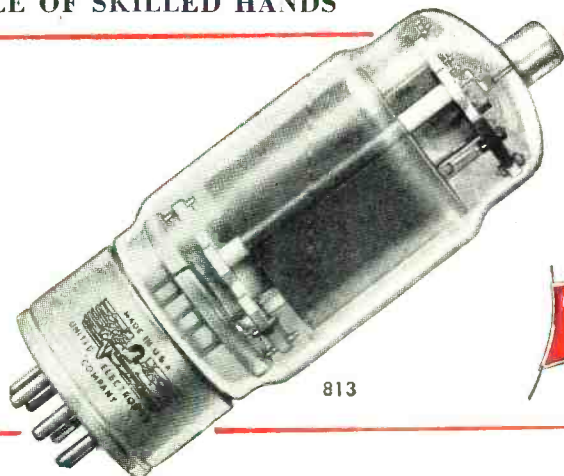

813



LAKE RADIO CABINETS

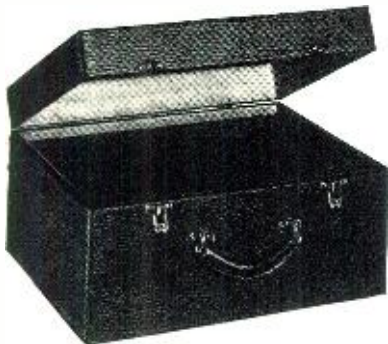

Portable Phonograph case, of sturdy durable plywood, in handsome brown leatherette finish. Inside dimensions 16½" long, 14" wide, 9½" high. Has blank motor board. As illustrated \$6.95 above, specially priced at..... **\$6.95**

Replacement cabinet in dark walnut finish plastic. Inside dimensions 10L x 6½H x 6D. Price **\$1.95**



Dark walnut finish plastic cabinet to accommodate practically any Tiny Tim radio. Size 7½L x 4½H x 4D. Price..... **\$1.50**

Also blank table cabinets of walnut veneer in the following sizes:

- #1—8¼" L x 5½" H x 4" D \$1.95
- #2—10¼" L x 6½" H x 5" D \$2.75
- #3—13½" L x 7½" H x 6¼" D \$3.25
- #8—17" L x 9" H x 9¾" D \$4.50
- #9—21" L x 9¼" H x 10½" D \$5.50

Cabinets available in ivory color and Swedish Modern. Write for prices.

POWER TRANSFORMERS

4, 5, or 6 Tube—6.3V at 2 amp. 50 mill Power Transformer..... **\$2.45**

7, 8, or 9 Tube—6.3V at 3 amp. 70 mill Power Transformer..... **\$2.65**

All types of radio parts available in today's market can be obtained at Lake's money-saving prices. Large stock listed in our new Bargain Bulletin. Write us for your copy. It's free.

LAKE RADIO SALES CO.

615 W. Randolph Street Chicago 6, Ill.

RADIO Wholesale REPAIR

THIS IS THE ANSWER TO YOUR RADIO REPAIR TROUBLES!

Just SEND us the SET via Railway Express. We REPAIR and RETURN. You ADD MARK-UP AND DELIVER. That's all there is to it.

- Complete Stocks—We can fix 'em all
- 90 day guarantee
- Prompt service
- OUR LOW PRICES mean more Markup for you.

Send that set to

SHEFFIELD RADIO CO.

916 BELMONT

CHICAGO 8

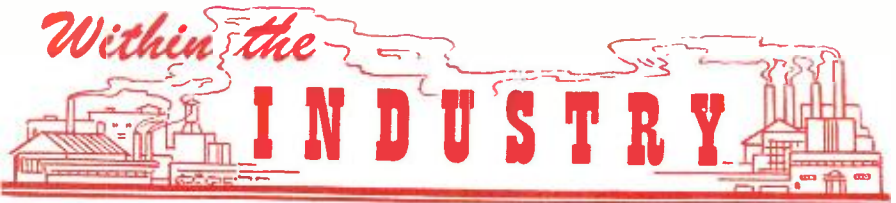

NORMAN L. CANNON, president of Cannon Electrical Supply Company of Charleston, South Carolina, is the new Stromberg-Carlson distributor for that area according to the announcement made by C. J. Hunt, manager of radio sales for the company. This appointment is one of several made recently.



At the same time, Mr. Hunt announced the return of Mr. E. S. Germain, pre-war sales manager of the Pacific Coast division, who has been on a leave of absence from this post with the company's government subcontract sales division.

The Adair Appliance Company of Memphis has been appointed exclusive area distributor of the company's postwar radio, FM, and television lines.

NATIONAL UNION CORPORATION, manufacturers of cathode-ray and electronic tubes has appointed Ejnar O. Sandstrom as controller of the corporation.

Mr. Sandstrom joined the company organization as an auditor in 1930. In addition to his duties as controller, Mr. Sandstrom will continue to serve as secretary to the company, a post which he has held since 1941.

ROBERT N. BAGGS is the new manager of the Merchandising Division of International Resistance Company according to the announcement made by Harry A. Ehle, IRC's vice-president and General Salesmanager. Mr. Baggs comes to IRC from RCA and brings 14 years' experience in the radio field with him to his new post. He is well known in the jobbing field and has a long experience in the merchandising field.



GALVIN MANUFACTURING CORPORATION, through its president, Paul V. Galvin, has announced the appointment of two new vice-presidents: Elmer H. Wavering, who will be in charge of the new Automotive Division and Walter H. Stellner, vice-president in charge of the new Home Products Division.

Mr. Wavering joined the Motorola organization as an engineer in 1930 and pioneered the design and engineering development of the first commercial car radio receiver during that

year. Later, Mr. Wavering became Sales Manager of the Car Radio Division, a position which he relinquished to become head of the Quartz Crystal Division.

Mr. Stellner joined the company in 1937 as Advertising Manager for the Home Radio Division. A year later he was promoted to the post of Sales Manager of this division. In 1942 he became head of the Washington Office of the Galvin Company.

R. S. CHAPMAN, of the firm of Chapman and Wilhelm, has predicted a

vast increase in the use of electronic equipment in the southern states after the war. His prediction was made recently when his company was appointed exclusive distributor for the Stromberg-Carlson postwar radio, FM, and television sets, for North and South Carolina. The area served by the firm, whose headquarters are in Charlotte, includes Durham, Greensboro, Winston-Salem, Asheville, and nearby areas. The higher standard of living made possible by wartime wages will provide an excellent postwar market in this area, according to Mr. Chapman.



HARRISON RADIO CORPORATION of New York has announced the appointment of Irving Phillips Wolfe to the post of Advertising and Assistant Sales Manager, through its president William E. Harrison.

Mr. Wolfe has been active in the advertising and sales promotion fields for over 15 years. He is a former Signal Corps and Air Corps instructor and a veteran of World War II. He is an old-time "ham" having been licensed as 2APJ since the early part of 1920.

Harrison Radio Corporation is a distributor and wholesaler of radio and electronic equipment to industrial firms, laboratories, amateurs, and radio servicemen.

WALTER E. PEEK has been named to the post of sales manager of the Electronic Laboratories, Inc. of Indianapolis, according to the announcement made recently by Mr. Norman L. Kevers, president of the company. Mr. Peek has been a member of the engineering staff of the company for the past



*Gates Brings You New Turntable Improvements that
assure Noiseless Positive Operation*

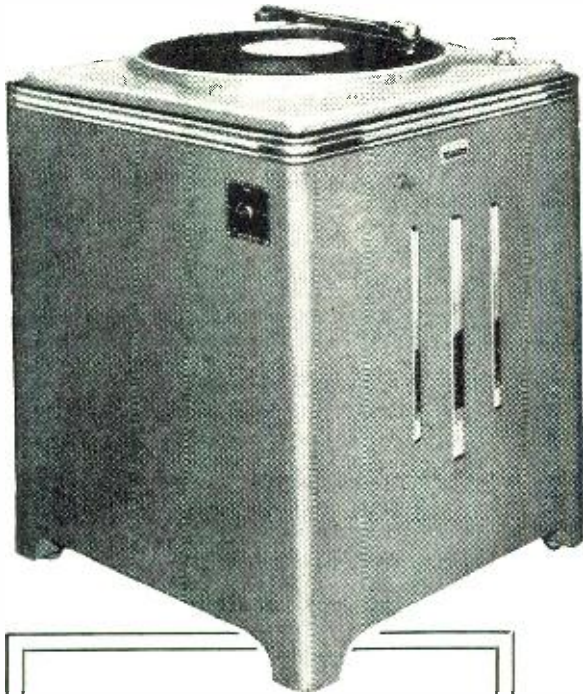

**THE GATES CB-7
Transcription
Turntable**

**Engineered for Exceptional Performance
Designed for those who Demand the Best**

Developed after months of experimentation with various synthetic rubbers that are impervious to oil and temperature, to provide an inside rim drive that is positive and "wow" free. The result is an efficient, yet handsomely designed, Turntable that is proving its sturdiness throughout the world under the most rigid wartime conditions—and here at home to the complete satisfaction of those who demand a trouble-free turntable for all recording and play-back purposes.

Planning for New Equipment?

Consider These Gates Advantages:

1. Heavy rugged construction combined with precision in its highest form . . .
2. Uses 1/50 HP of inside rim drive. Proved choice of discriminating engineers . . .
3. Inbuilt long life, for years of continuous service with minimum attention . . .
4. Instantaneous speed change combined with "wow" free accuracy and regulation . . .
5. Electrical reproducing set supplied for all popular playback requirements, with accentuating and high fidelity response characteristics . . .
6. Designed for the hardest, most exacting professional usage . . .
7. Ball bearing motor.

Available Now on Proper Priority

(Wartime restrictions do not allow the sale of new broadcasting equipment without priority; therefore, this equipment is presented merely to acquaint you with Gates' developments. Our post-war priority delivery system may be of interest. Write at once for details.)

Gates

**RADIO COMPANY
QUINCY, ILLINOIS, U. S. A.**

MANUFACTURERS OF RADIO BROADCAST TRANSMITTERS, SPEECH EQUIPMENT RECORDING APPARATUS AND ALLIED EQUIPMENT IN THE ELECTRONICS FIELD

IMMEDIATE DELIVERY FROM STOCK

SPRAGUE - CORNELL DUBILIER AEROVOX CONDENSERS



- 10 mfd 450v Tubular . . . 50¢
- 16 mfd 450v Tubular . . . 65¢
- 20 mfd 450v Tubular . . . 70¢
- 40 mfd 450v Tubular . . . 99¢
- 20 mfd 150v Tubular . . . 44¢
- 30 mfd 150v Tubular . . . 47¢
- 40 mfd 150v Tubular . . . 50¢
- 20-20 mfd 150v Tubular . . . 76¢
- 40-20 mfd 150v Tubular . . . 82¢
- 30-30 mfd 150v Tubular . . . 79¢
- 50-30 mfd 150v Tubular . . . 94¢
- 10 mfd 50v Tubular . . . 32¢
- 25 mfd 25v Tubular . . . 35¢

- .001 mfd 600v . . . 12¢
- .002 mfd 600v . . . 12¢
- .003 mfd 600v . . . 12¢
- .004 mfd 600v . . . 12¢
- .005 mfd 600v . . . 12¢
- .005 mfd . . . 12¢
- .01 mfd . . . 12¢
- .02 mfd . . . 12¢
- .05 mfd . . . 15¢
- 1 mfd . . . 18¢

RSE BY-PASS CONDENSERS

600 Volt - Nationally Advertised - Guaranteed

Capacity	Each	Lots of 10	Lots of 100
.001 mfd.	\$.03	\$.70	\$6.00
.004 mfd.	.08	.70	6.00
.01 mfd.	.08	.70	6.00
.02 mfd.	.08	.70	6.00
.05 mfd.	.10	.80	7.00
.1 mfd.	.12	.90	8.00

TURNER MICROPHONES

Model	Type	Cord	List	Your Cost
BX	Crystal	7'	\$9.95	\$5.85
22X	Crystal	7'	18.50	10.88
33X	Crystal	20'	22.50	13.23
BD	Dynamic	7'	14.50	8.53
33D	Dynamic	20'	23.50	13.82



PM SPEAKERS

5" Round	1.25
6" Round 3.6 oz.	2.10
10" Round 20 oz.	7.20
12" Round 11 oz.	5.19
12" Round 20 oz.	7.35

AC-DC RESISTANCE CORDS

Each	10 for	Price
135-160-180-220-250-290 OHM		4.50
ICA Universal 22-330 ohm		73¢
560 ohm for 3-way Portable		73¢

BALLAST TUBES

- K42B K55B L49C L55B 100-79
 - K49B K55C L49D 100-70
 - 100-77
- Each 45¢ 10 for 4.20
 Clarostat Universal 23-55A (octal) each 59¢

20% deposit required on all C. O. D. orders. Orders of \$25.00 or more accompanied by payment in full, will be shipped prepaid. DON'T FORGET L-265 or AA-3 certificate.

RADIO SUPPLY & ENGINEERING CO., Inc.
 129 SELDEN AVE. DETROIT 1, MICH.

RCA INSTITUTES
 Offer thorough training courses in all technical phases of Radio and Television
WEEKLY RATES DAYS—EVENINGS
VETERANS: RCA Institutes is approved under G. I. Bill of Rights
 For Free Catalog write Dept. RN-45
RCA INSTITUTES, Inc.
 A Radio Corporation of America Service
 75 Varick St., New York 13, N. Y.

Ted McElroy
 World's Largest Manufacturer of Wireless Telegraphic Apparatus
 COMPLETE CENTRAL OFFICE EQUIPMENT
McElroy Manufacturing Corp.
 82 Brookline Avenue • Boston, Massachusetts

four years, serving both as a design and sales engineer, specializing in the vibrator field. In his new capacity, Mr. Peek will be in charge of sales for all of the products manufactured by Electronic Laboratories, Inc.

* * *

ROYAL J. HIGGINS has been appointed representative for The Turner Company of Cedar Rapids, Iowa. He will assist purchasers of the Turner line of microphones in the Greater Chicago area. Mr. Higgins is well known in the radio industry as he has been an active "ham" since 1923 and maintains his own station, W9AI0. He was formerly employed by Sears Roebuck and Company and Hallicrafters. His offices in Chicago are located at 600 South Michigan Avenue.



* * *

EMERSON RADIO AND PHONOGRAPH CORPORATION has announced the appointment of two new distributors for the company's line of radio and television sets.

The Sunset Electric Company of Spokane, Washington, will act as distributor for the Spokane area. Mr. R. M. Spiger is the manager of this branch of the company and J. H. Johnson is the radio salesmanager.

The Capitol Distributing Company of Providence, Rhode Island, is the second distributor to be granted the Emerson franchise. This newly organized wholesaling firm is headed by Morrie and Roy Rosenfeld who have been connected with the Emerson organization for many years. Active management of the Emerson line will be under the direction of Mr. Roy Rosenfeld.

* * *

E. GUY FLAIG has been elected to the post of president of the radio division of the Cincinnati Electrical Association. Mr. Flaig has held various positions in the appliance field, including sales manager for RCA and branch and regional manager of the Crosley Corporation. At the present time, he is the manager of the appliance division of the Bimel Company of Cincinnati, distributors of Admiral radios and home appliances.



* * *

RADIO CORPORATION OF AMERICA has announced the appointment of Chester C. Aiken to the staff of the Electronic Apparatus Section of the RCA Victor Division in Camden, New Jersey.

Mr. Aiken has been associated with the field engineering training and personnel division of RCA since 1928. In his new post Mr. Aiken assumes commercial responsibilities for electronic

equipment now under experimental development for quality control and inspection of liquids.

Mr. Aiken entered the RCA organization in 1928 as the head of a staff charged with training field engineers in the service division of RCA Telephone, Inc. In 1936 he organized the executive training program to recruit outstanding college graduates and supervised their training and initial experience. In 1943 he was appointed to RCA's national Personnel Administration staff, in charge of recruiting technical and specialized personnel.

* * *

THE HALLICRAFTERS COMPANY of Chicago has announced the appointment of Charles Knoblauch to the post of superintendent of the firm's Clearing Plant.

Mr. Knoblauch, who was formerly assistant superintendent of Hallicrafters' 26th Street Plant, has been with the company more than six years. His experience includes over seventeen years in the radio production field.

* * *

DAVID M. SALISBURY is the new vice-president and general manager of the Westinghouse Electric Supply Company, according to the announcement made by B. W. Clark, president of the organization. In his new position, Mr. Salisbury will head the company's operations. The supply company is the wholesale outlet for the appliances manufactured by the parent company, Westinghouse Electric and Mfg. Co.



* * *

FEDERAL TELEPHONE AND RADIO CORPORATION has announced the appointment of Frank O. Zimmerman of Oak Park, Illinois as assistant manager of the Chicago Sales branch of the company.

Mr. Zimmerman formerly was employed by the Westinghouse Electric Elevator Company at Chicago and Indianapolis. He is a graduate of the Illinois Institute of Technology in electrical engineering.

* * *

BURLINGAME ASSOCIATES has organized a new Instrument Repair section under the direction of William E. Adams.

Because many test instruments badly needed for war production and essential civilian use are out of commission due to lack of repair facilities by the manufacturer or the shortage of small parts, the company feels that the new service will be of value to many persons.

The company has requested that persons having instruments to be repaired write to the company first giving the make of the instrument and other pertinent data before shipping the instrument in for repairs.

The company is located at 11 Park Place, New York, New York.

Breeze Flexible Conduit

for shielding or ducts



Breeze Flexible Tubing, manufactured in many diameters from a wide variety of metals, is used as ventilation and exhaust ducting in industrial, aircraft, marine and automotive applications. The same basic tubing, with the addition of a braided metal covering, becomes light-weight shielding conduit, used extensively for shielding ignition systems and any electrical circuit to insure dependable radio communication.

Manufactured from a continuous strip of metal, Breeze Flexible Tubing and Conduit can be furnished cut to length, with necessary end-fittings for any conduit installation.

Many different types of interlock construction — plain, packed, and soldered—are available to meet varying use requirements. A few of these are illustrated below.

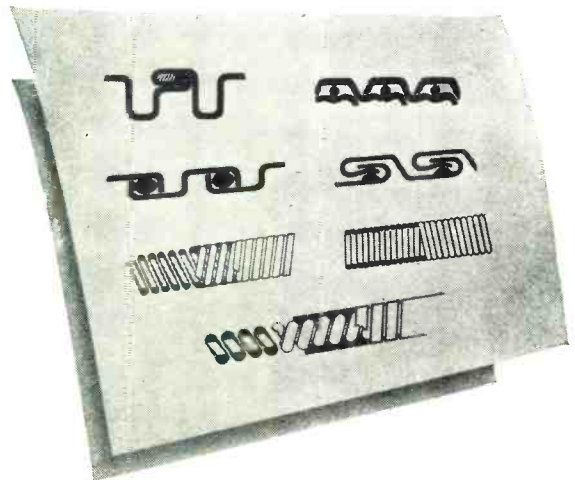

Breeze



CORPORATIONS, INC.

Newark, New Jersey

NOW—A REALLY HIGH-POWERED— Radio Engineering Library

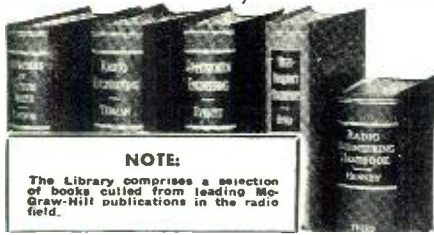

NOTE:

The Library comprises a selection of books culled from leading McGraw-Hill publications in the radio field.

- especially selected by radio specialists of McGraw-Hill publications
- to give most complete, dependable coverage of facts needed by all whose fields are grounded on radio fundamentals.
- available at a special price and terms

THESE books cover circuit phenomena, tube theory, networks, measurements, and other subjects—give specialized treatments of all fields of practical design and application. They are books of recognized position in the literature—books you will refer to and be referred to often. If you are a practical designer, researcher or engineer in any field based on radio, you want these books for the help they give in hundreds of problems throughout the whole field of radio engineering.

5 VOLUMES, 3559 PAGES, 2558 ILLUSTRATIONS

1. Eastman's FUNDAMENTALS OF VACUUM TUBES
2. Terman's RADIO ENGINEERING
3. Everitt's COMMUNICATION ENGINEERING
4. Hund's HIGH FREQUENCY MEASUREMENTS
5. Henney's RADIO ENGINEERING HANDBOOK

10 days' examination. Easy terms. Special price under this offer less than books bought separately. Add these standard works to your library now; pay small monthly installments, while you use the books.

10 DAYS' FREE EXAMINATION—SEND COUPON

McGraw-Hill Book Co.
330 W. 42nd Street, New York 18, N. Y.

Send me Radio Engineering Library, 5 vols., for 10 days' examination on approval. In 10 days I will send \$3.00 plus few cents postage, and \$3.00 monthly till \$24.00 is paid, or return books postpaid. (We pay postage on orders accompanied by remittance of first installment.)

Name

Address

City and State

Position

Company

RN-245

**for EVERY HOBBY SHOP!
and HOME CRAFTSMAN!**

**NEW
WARNER
Brush
ELECTROPLATER!**

DECORATE Your MODELS and PROJECTS with GOLD, SILVER, NICKEL, COPPER

If you have a hobby—a home workshop—you need this new battery model Warner Electroplater. Easily and quickly, you can electroplate models and projects; you can replate worn articles, faucets, tools, silverware, etc. with beautiful coat of gleaming metal. Equipment includes 10" x 14" Control Panel, Variable Voltage Regulator, Work and Brush Terminals, Battery Connectors, Patented NYLON-LUCITE Electrolytic Brush with 4 Anodes. All necessary supplies: Electroplating Compounds for Gold, Silver, Nickel, Copper—also Degreaser, Cleanser, Instruction Book and Wiring Diagram.

**The TOOL of
A 101 USES**

Be proud of your work! Electroplate your models. Decorate metal projects. Replate worn objects. It's easy!

Get more fun from your hobby, make your workshop complete, order your battery model Warner Electroplater today. ONLY \$19.75, shipping charge collect.

**DEALERS
Hobby Shops**
Feature this new tool in your store
WRITE FOR
DETAILS!

WARNER ELECTRIC CO.
Dept. A-72, 360 N. Michigan • Chicago 1, Ill.

Electrical Gunsight

(Continued from page 34)

amount of leeway in the adaptation of this sight to various turrets.

Of the various factors involved, range, as has been said, is derived from the sight head's reticle and is set into the computer unit by the foot control assembly. Indicated air speed and altitude are set in manually by means of controls located on the computer unit. They do not have to be put in automatically since they do not vary appreciably during combat. Wing span of the target also is set in manually.

Azimuth gun elevation is supplied by an attenuator driven by means of flexible shafts connected to the turret gearing.

The angular velocity of the target is indicated by specially designed d.c. generators connected to the turret and gun elevation drive. These generators are similar to electrical tachometers, but instead of the usual permanent magnet fields used in such devices, they have wound fields and use laminations with extremely small hysteresis loss loops to maintain the linearity of output within 1%. This is necessary because the linear relationship computation involves multiplication of angular velocity in either direction, as indicated by the shaft speed of the generator by the time of flight, indicated by the strength of the current in the field of the generators.

The time of flight current is ob-

tained from an electrical attenuator network especially developed for this purpose. The attenuators themselves are basically the same as those which have been used for years in the radio industry, but they have been adapted to meet much greater accuracy requirements than previous applications have demanded. The problem of obtaining this accuracy and the special tapers required for the various attenuators was worked out in conjunction with *Clarostat*, a concern of long experience in this field. Attenuators—or T-pads, as they are known—are used in the computing network in order to maintain constant circuit impedance while the attenuation is being altered to correspond to the various factors entering into the computation.

Figs. 6 and 7 show the method of approach to the problem of designing an electrical computing network. The three sets of curves in Fig. 6 are the result of flight tests and computations both theoretical and practical. Fig. 7 represents an electrical computing network which will produce a voltage varying in accordance with these curves.

The curves show the variation of time of flight with four factors A, B, C, and D. Two conditions of C are shown, with D remaining fixed, and two conditions of D, C remaining fixed. In each group five conditions of B are illustrated. It will be seen that under the condition B, time of flight is affected by C and D and not by A. In Fig. 7 generator 1 supplies a voltage proportional to the time of flight corresponding to B, under condition

Fig. 7. General representation of the electrical computing network, which, when properly designed, will produce a voltage varying in accordance with the curves of Fig. 6.

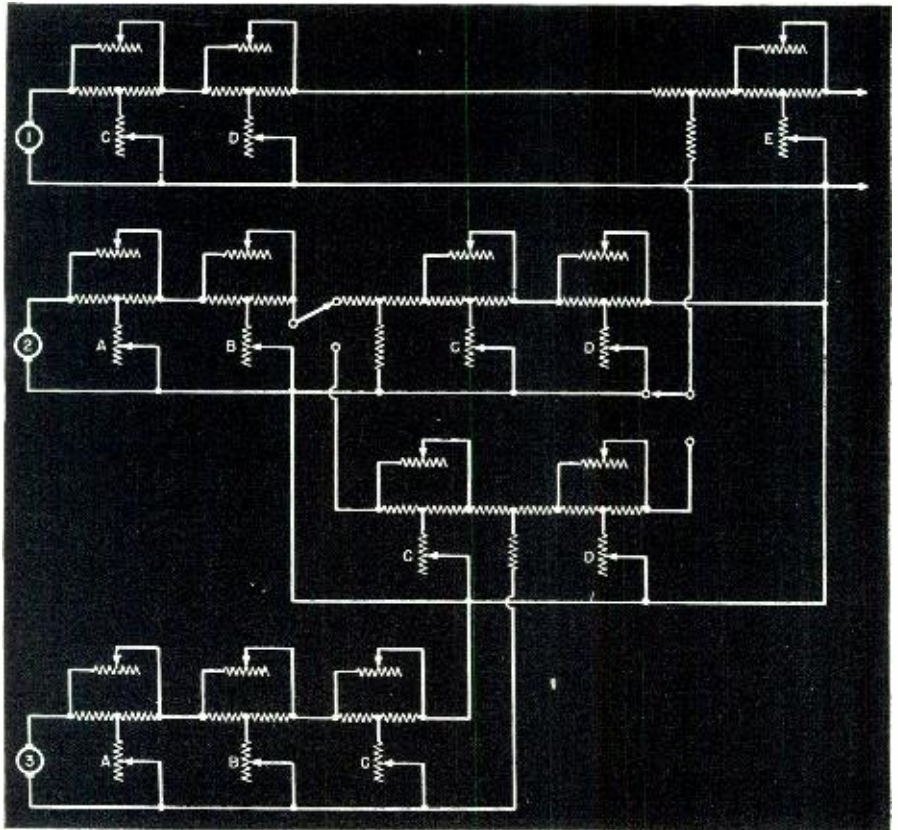

The Time is NOW!



Temple - Planned Territory Protection Means "signing up" Today!

No, it isn't a case of "first come, first served"—we're too "choosey" for that. The fact is that Temple-planned territory protection means real territory protection — a minimum of conflict as well as a maximum of sales and profits for every Temple distributor and every Temple dealer. Which, in turn, means a restricted number of Temple outlets for each trading area.

With the ever-increasing demand for the

Temple Franchise, we urge that you communicate with us immediately regarding your territory.



TEMPLE TONE RADIO MFG. CORP., New London, Conn.

FM . . . TELEVISION . . . RADIO-PHONO' COMBINATIONS

"WHERE **FM** WILL ALSO MEAN **F**INEST **M**ADE"

Licensed under Armstrong and RCA patents.

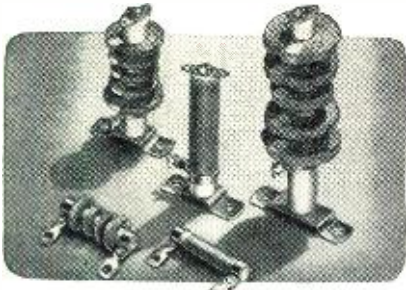

R. F. CHOKES

Illustrated are standard stock chokes designed to cover a band of frequencies. Uniformly flat in response, Johnson R. F. chokes are equally effective over the entire range for which they were designed. Wire is enameled, silk covered, impregnated with low loss R. F. lacquer, and wound on steatite cores. Available in several current ratings.

Also available on special order are high current chokes for large transmitter applications. These special chokes are individually designed to operate on a specific frequency in such applications as tower lighting circuits and in power supply circuits. Send your specifications to Johnson for recommendations and quotations.

Ask for Catalog 968 (Z)

JOHNSON
a famous name in Radio

E. F. Johnson Co. Waseca, Minn.

CORWICO

WIRES

MADE BY
Engineers FOR Engineers

VICTORY
concentrating upon
for the duration

cornish
WIRE COMPANY, INC.
15 Park Row, New York City, New York

CORWICO

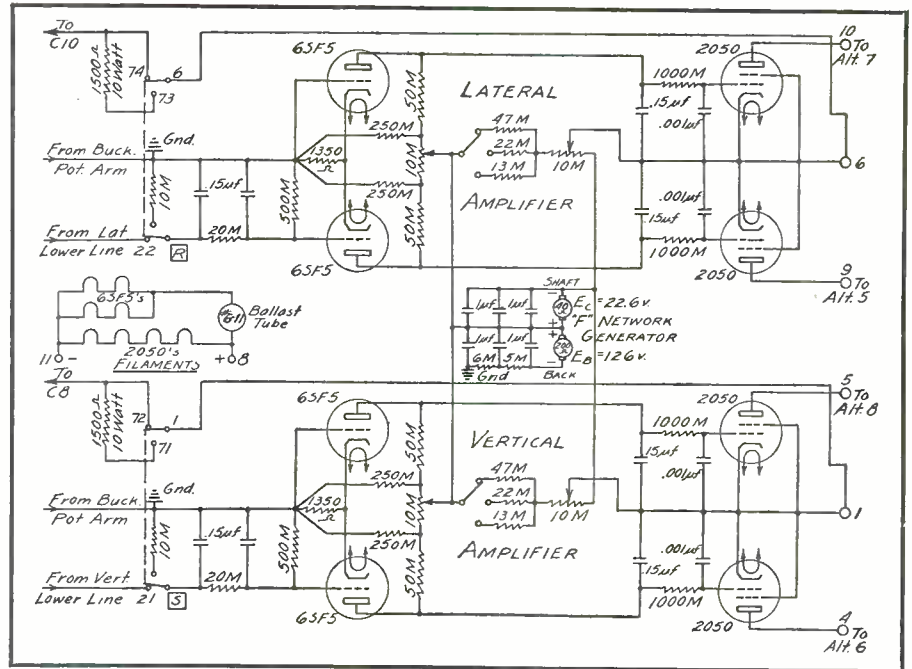

Fig. 8. Circuit diagram of the amplifiers, two of which are used in the complete unit, one for lateral and the other for vertical deflection.

C_1D_1 , which voltage is attenuated by attenuator C in accordance with the variation of time of flight with factor C under condition B_3 . It is further attenuated by attenuator D in series with C in accordance with the variation of time of flight with factor D.

Considering only condition C_1D_1 in Fig. 6 for the moment it will be seen that if a voltage proportional to the maximum difference between B_1-B_3 is subtracted from the voltage corresponding to B_3 the point X on B_1 will be obtained. If this second voltage is then attenuated in accordance with the variation with factor A, the complete curve B_1 can be obtained. Another attenuator in this second circuit varies this second voltage still further in accordance with the variation of factor B. Inspection of the other two groups of curves illustrated shows that the difference between the values B_1 and B_3 are less in each case than in the case of C_1D_1 . Consequently, it is also necessary to provide C and D attenuators in this second or auxiliary circuit, as it is called. With the attenuators thus far mentioned, a voltage proportional to time of flight for all conditions between B_1 and B_3 for all values of A, B and C will be obtained.

To secure a voltage proportional to time of flight for conditions between B_3 and B_5 it is necessary to add a voltage to that corresponding to B_3 under condition C_1D_1 . It was found by extending the curve B_3 as indicated by the dotted line, some of the attenuators already mentioned as being used in the first auxiliary circuit, could be used for these conditions also. To do this, reversing switches are provided in the auxiliary circuit to cause the voltage from generator 2 to be added to that from generator 1 rather than subtract it as in the previous case.

Inspection of the curve shows that the same A and B attenuators can be used but since, as illustrated under conditions C_1D_2 and C_2D_1 , the attenuation on the right hand side must be much more rapid than on the left with C and D, different C and D attenuators must be provided. This is accomplished easily by merely switching different C and D attenuators into the circuit as shown in Fig. 7. Since the distance from X to B_3 is less than that from B_3 and Y, it is obvious that a greater voltage is required in the latter case.

This is accomplished by providing a voltage from generator 2 corresponding to the distance B_3Y . A fixed amount of attenuation is then switched into the circuit for conditions between B_1 and B_3 . A second auxiliary circuit is used to provide a voltage corresponding to the distance ly . This voltage is subtracted from the sum of the other two voltages and is attenuated much more rapidly with factors A and B, as can readily be seen from inspection of the curve. A different value of attenuation for factor C is also necessary in this second auxiliary circuit. However, it is found that attenuation for factor D is the same as in the case of the first auxiliary circuit. Consequently, the second auxiliary circuit is connected into the first auxiliary circuit prior to factor D which thus modifies the output of both circuits.

In a similar manner it was found that the factor E affected all circuits equally. Consequently, the first auxiliary circuit is connected to the main circuit prior to the attenuator for factor E, whose current or voltage is proportional to the time of flight under all conditions of all five factors illustrated. If necessary, still further refinement could have been added by the inclusion of further auxiliary circuits.

GREAT NEWS! SUPERIOR'S WELL-KNOWN

Model 710

VOLT—OHM—MILLIAMMETER

is now available for shipment within 10 days after receipt of order on priority of AA3 or better.

Sensitivity—

1,000 OHMS PER VOLT
ON BOTH A.C. AND D.C. II

Measures:—

A.C. AND D.C. VOLTAGES
UP TO—

1500 VOLTS

A.C. CURRENT UP TO—

3 AMPERES

D.C. CURRENT UP TO—

30 AMPERES

RESISTANCE UP TO—

10 MEGOHMS

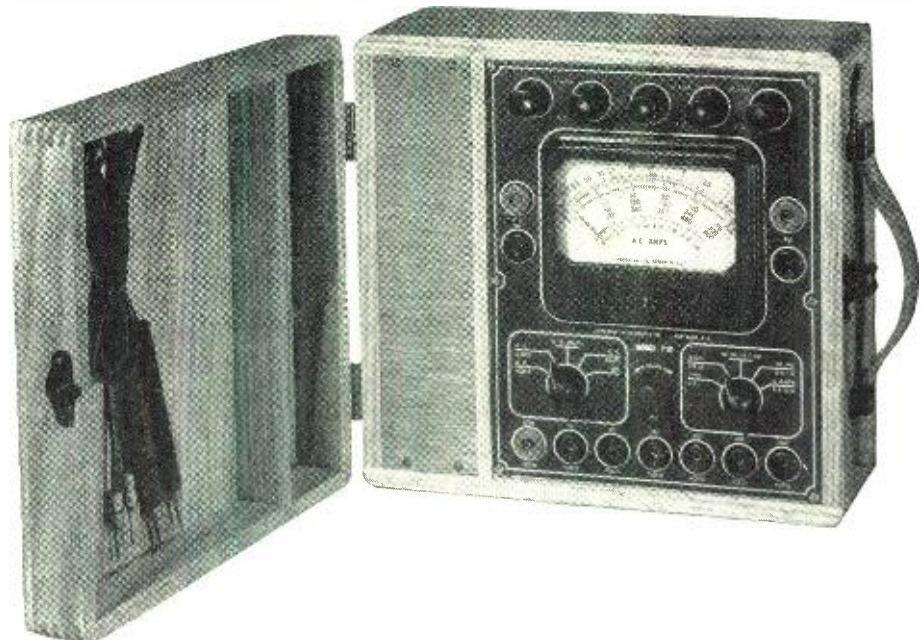

Features:—

- ★ Uses New 4 1/2" Square Rugged 0-400 Microampere Meter.
- ★ Direct Reading—All Calibrations Printed Directly on Meter Scale in Large Easy-to-Read Type.
- ★ Housed in Rugged Heavy Duty Portable Oak Cabinet.
- ★ Completely Self-Contained—No External Source of Current Required.

Designed and perfected in wartime to meet the exacting requirements of America's War Producers for a dependable volt-ohm-milliammeter, the Model 710 is being used by war

plants engaged in the production of planes, ships, tanks, guns, etc.; also by various Army, Navy and other government agencies.

Specifications:—

6 D.C. VOLTAGE RANGES (1000 OHMS PER VOLT)

0 to 15/60/150/300/600/1500 Volts.

6 A.C. VOLTAGE RANGES (1000 OHMS PER VOLT)

0 to 15/60/150/300/600/1500 Volts.

7 D.C. CURRENT RANGES:

0 to 3/15/60/150 Milliampers

0 to 3/15/30 Amperes.

A.C. CURRENT RANGE:

0 to 3 Amperes.

5 RESISTANCE RANGES:

0 to 1,000/10,000/100,000 Ohms.

0 to 1 Megohm

0 to 10 Megohms.

The MODEL 710 comes complete with cover, self-contained batteries, test leads and instructions. Size 6" x 10" x 10". Net weight 11 pounds. Price.....

\$ 34⁵⁰

SUPERIOR INSTRUMENTS CO., Dept. R.N.

227 FULTON STREET

NEW YORK 7, N. Y.

IMMEDIATE DELIVERY RADIO PARTS AND SOUND EQUIPMENT

Hookup wire—short lengths—69c pound.

Hookup and Push back wire—assorted colors—rubber, cotton and plastic cover—89c per 100'—10 assorted 100' rolls \$7.80

- 20 Mfd 150 V Tubular condensers... 37c
- 20-20 Mfd 150 V Tubular condensers 60c
- 20-30 Mfd 150 V Tubular condensers 69c
- 4" ElectroDynamic Speakers 450 ohm \$1.68
- 5" ElectroDynamic Speakers 450 ohm 1.86
- 6" ElectroDynamic Speakers 450 ohm 2.58
- 5" 6 Volt Auto Speakers..... 1.68
- 6" 6 Volt Auto Speakers..... 1.95
- 7" 6 Volt Auto Speakers..... 1.59
- 8" 6 Volt Auto Speakers..... 1.59
- 6x9" 6 Volt Oval Auto Speakers... 1.59

10 Watt Wire Wound Resistors, all values 24c

Write for latest bulletin listing hundreds of items for the radio service man and sound man. FREE.

**LIFETIME
SOUND EQUIPMENT CO.**
1103 Adams Street Toledo 1, Ohio

**7 Days
Free Examination**

PRACTICAL RADIO INFORMATION

Including Frequency Modulation—Television, etc. Inside Radio Information for all Servicemen—Aircraft Pilots, Students. AUDELS RADIOMANS GUIDE contains 772 Pages, 400 Diagrams & Photos is complete—gives Authentic Principles & Practices in Construction, Operation, Service & Repairs. Covers clearly and concisely Radio fundamentals—Ohm's Law—Physics of sound as related to radio science—Measuring instruments—Power supply—Resistors—Inductors—Condensers—Transformers and examples—Broadcasting stations—Radio Telephony—Receivers—Diagrams—Construction—Control systems—Loud speakers—Antenna systems—Auto Radio—Phonograph pickups—Public Address Systems—Aircraft & Marine Radio—Radio Compass—Beacons—Automatic Radio Alarms—Short Wave—Coil Calculations—Testing—Cathode ray oscillographs—Static Elimination—Trouble Pointers—Underwriter's standards—Units and tables—Frequency Modulation—REVIEW QUESTIONS & ANSWERS. Ready Reference Index.

\$4 COMPLETE • PAY ONLY \$1 A MO. Get this practical information in handy form for yourself—Fill in and MAIL COUPON TODAY

AUDEL Publishers, 49 W. 23rd St., N.Y. Mail AUDELS NEW RADIOMANS GUIDE for free examination, if O. K., I will send you \$1 in 7 days; then remit \$1 monthly until \$4 is paid. Otherwise I will return it.

Name.....
Address.....
Occupation.....
Reference..... R.N.

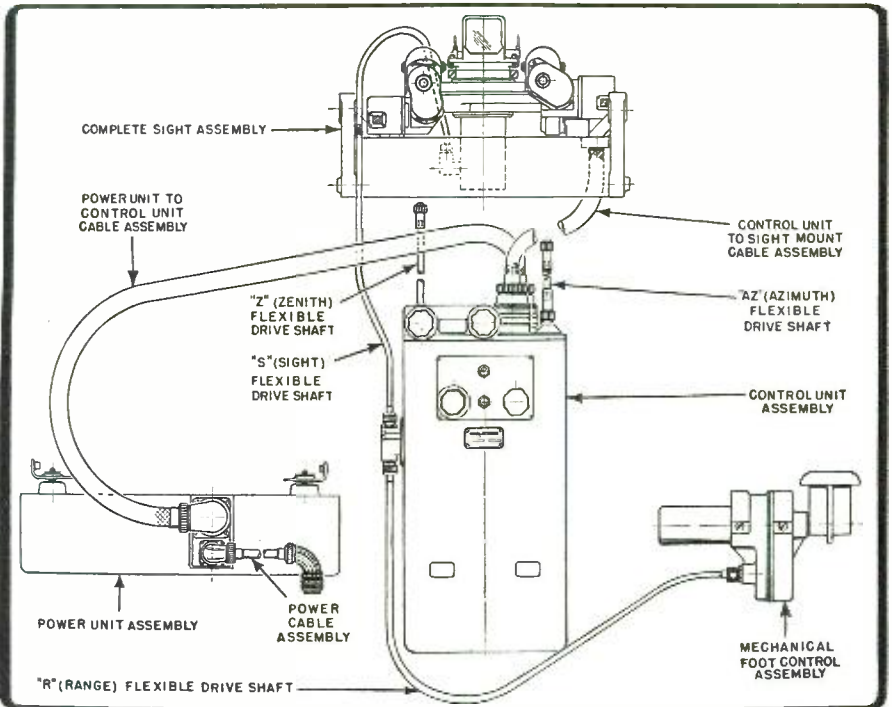

Fig. 9. Diagram of the arrangement of component parts of this electrical gunsight.

But the values obtained here for time of flight are within 0.01 of a second, which would correspond to an insignificant error of less than 1 yard at 1,000 yards for a relative speed of 200 miles an hour.

(EDITORS NOTE: Figs. 6 and 7 were included and discussed in this article to give the reader a general idea as to how an electrical network of attenuators could be designed to operate a mechanical device which automatically compensates for various variable factors, such as would be encountered in this automatic gunsight. The curves of Fig. 6 and diagram of Fig. 7 do not include or mention the actual factors involved or the values of the electrical components that finally were arrived at. More detailed information has been omitted purposely for security reasons.)

Lateral and vertical ballistic deflections are computed with circuits very similar to the one just described. The voltage from the vertical ballistic deflection circuit is added to that from the vertical relative velocity generator and the result then delivered to the computer unit. The same process takes place with the lateral ballistic voltage except that the lateral velocity generator voltage to which it is added is modified by a gun elevation attenuator. This is necessary because the azimuth relative velocity generator is driven by the rotation of the turret in the horizontal plane while the sight is offset at a variable angle to this plane.

The sight offset creates a problem which has been solved, in the K-8, by the addition, mentioned further back, of an auxiliary generator on the same shaft as the lateral offsetting motor.

Space and weight limitations in a gun turret make it more practicable to offset the sight itself rather than the guns. One complication here is that any offset of the sight tends to move it off the target and the gunner then has to rotate his turret to bring it back. This rotation causes relative

velocity which in turn brings false velocity into the system. Also the compensating rotation causes a still greater offset of the sight, resulting in an unstable system.

In the mechanical gunsight this was overcome by the introduction into the system of a fixed amount of damping, in the form of a time lag. The disadvantage here is that the fixed amount gives a satisfactory correction for only one range and one set of conditions of altitude, air speed, azimuth and gun elevation position. At short range it is much too sluggish to be of benefit and at long range it is so insufficient that the gunner has difficulty staying on the target.

The K-8's auxiliary generator gives the sight a uniform performance at all ranges. Its velocity is proportional to the rate at which the sight is offset and it receives the same time of flight current as is supplied to the fields of the velocity generators. Its output (velocity of offset) is subtracted from that of the relative velocity generator (turret velocity) and the result is true target velocity.

Servo System

The K-8's Servo System, a direct result of the great development in the art of electronics within the past few years, is what converts the voltages into the final answer in the form of mechanical action. Its principal parts are the d.c. amplifier and the alternator contained in the power supply unit. The amplifier takes the voltage from the computer and, acting as a valve or switch, passes this on through the alternator which drives the sight motors.

Fig. 8 shows a circuit of the amplifiers, two of which are used in the complete unit, one for lateral and the other for vertical deflection. It was

wherever a tube is used . . .



for example:

COMBUSTION CONTROL

An abnormal increase in the density of smoke passing through a boiler breeching means a reduction of heat, loss of efficiency, increase in fuel consumption, and probably violation of smoke control ordinances. The electronically operated Worner Combustion Supervisor detects such conditions, turns in an audible or visible alarm, and sets in motion the mechanism that will bring about efficient combustion.

Control Unit

THERE'S A JOB FOR *Relays* BY GUARDIAN

The "Combustion Control Supervisor," made by Worner Electronic Devices of Chicago, is a photo-cell system that responds to any predetermined degree of smoke density. To avoid "false alarms" resulting from momentary puffs of smoke, it is equipped with a time delay feature.

Worner's specified that the three relays used in this system must be sensitive but not delicate; that they require no adjustment; and that they meet Underwriter's requirements.

Guardian engineers developed the Series 155 D.C. relay as the answer to these specifications. This is a compact, sturdy, easily mounted unit with constant spring tension on the contacts. It is widely used on remote selection devices and other low voltage applications. Copper slug time delays up to .05 seconds on attract and 0.15 seconds on release are available. Coils for operation on any voltage up to 230 volts D.C. For further information write for Series 155 bulletin.

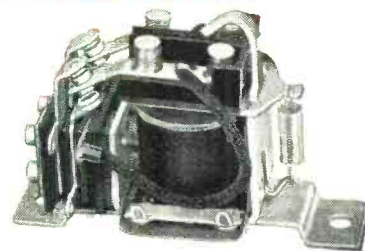

Series 155 D.C. Relay

Consult Guardian whenever a tube is used —however—Relays by Guardian are NOT limited to tube applications, but are used wherever automatic control is desired for making, breaking, or changing the characteristics of electrical circuits.

GUARDIAN ELECTRIC

1630-B W. WALNUT STREET

CHICAGO 12, ILLINOIS

A COMPLETE LINE OF RELAYS SERVING AMERICAN WAR INDUSTRY

The IMPROVED
KELNOR
REG. U. S. PAT. OFF.
electric SOLDERING IRON



about 1/2
actual size;
weighs 1/2 lb.

specialy
designed
for most
efficient
soldering
in the

**ELECTRONIC,
RADIO AND
INSTRUMENT
manufacturing and
repairing fields**

Easily solders hard-to-reach connections.
Cuts down fatigue, increases accuracy.

ORDER FROM YOUR JOBBER, OR DIRECT.
GENERAL OFFICES: CENTRAL TOWER, SAN FRANCISCO 3

KELNOR MANUFACTURING COMPANY

When Ordering Please Mention RADIO NEWS

I'm Helping Hundreds Get Ready
for EVEN BETTER Post War Jobs in
ELECTRICITY

"Learn-by-Doing"
12 Weeks Shop Training.
I'll Finance Tuition



Prepare for changing conditions! Maybe your present job is okay, but who knows about tomorrow. Protect your future! Get practical shop training at COYNE and be prepared for a peacetime future. If short of money I'll finance most of your tuition. If you need part-time work to help out with living expenses, I'll help you get it.

Be an All-Round Electrician
Some men just know one or two branches of electrical work. From there on they're lost. COYNE "Learn-by-Doing" fits you for many profitable branches of Electricity.

Industrial Electronics Included
Right now I'm including extra training in the great new field of Industrial Electronics at no extra cost.

BIG BOOK FREE!
Mail coupon for my big free book. Get the training you need for a good electrical job. MAIL NOW.

A FEW OF THE MANY JOBS!
Air Conditioning
Refrigeration
Power Plants
Industrial Electronics
House Wiring
Illumination
Appliances
Motors-Generators
Wiring-Testing and Repairing

We have special facilities for men with physical disabilities. If you have a physical disability of any kind, write me when you send the coupon.

H. C. Lewis, Pres., COYNE ELECTRICAL SCHOOL
500 S. Paulina St. Dept. 25-81 Chicago 12, Illinois

H. C. Lewis, President, Coyne Electrical School
Dept. 25-81 500 S. Paulina St., Chicago 12, Ill.

Send Free Book with Facts on Coyne, "Pay After Graduation" Plan and extra Industrial Electronics training which is now included.

NAME.....
ADDRESS.....
CITY..... ZONE..... STATE.....

designed especially to combine great accuracy and yet be able to withstand the vibration and gun shock encountered in an aircraft turret. It has a sensitivity of 20 millivolts and performs throughout a temperature range of from 65 degrees below zero to 160 degrees above, and a humidity range of 0 to 95%. Its sensitivity is maintained at maximum by the provision of balance and bias adjustments to take care of any variation in the tubes (when, for instance, the voltage in the plane varies radically from the standard voltages). The voltage range specified is of 26 to 32 volts, and the sensitivity will remain within about 10 to 40 millivolts, which would correspond to only a 2-yard error at 1,000 yards, well within the accuracy of the gun itself.

Each offset motor (split-field series) is powered through a pair of 2050 thyratrons whose plates are connected respectively to two phase outputs of the alternator, time phased 180° apart. The sight is offset in one direction or another, depending on which of the motor's fields is energized by the firing of the associated thyatron. This, in turn, is determined by the polarity of the d.c. computed voltage on the grids of the 6SF5 voltage amplifier tubes which drive the grids of the 2050 thyratrons.

The motor's degree of rotation is controlled by the "follow-up" system. This includes two bucking potentiometers, one for each motor, supplying an opposing voltage at the input grids of the amplifier. Each of these is mechanically driven, simultaneously with the sight offset and is powered from a permanent magnet generator driven by the same drive motor as the generators supplying the computing network. Thus, network voltage and potentiometer voltage vary proportionately due to any speed changes in the drive motor and cancel out this variable. When the potentiometer is rotated by the sight motor, a bucking voltage finally is established that is equal and opposite to the computer voltage, reducing the net input signal reduced below its threshold sensitivity. The thyratrons are di-ionized and the motor stops. Variations in the speed of the motor driving the generators, as pointed out above, do not affect the computation in any way, and mechanical backlash is held to an absolute minimum by the fact that the potentiometers are driven on the same shaft which offsets the sight.

This instrument has extended the effective range of .50 cal. machine guns from 400 to 1,000 yards. A pursuit ship must now fly through six or eight hundred yards of deadly gunfire in order to press home an attack.

Although it is at present primarily a weapon of war, it has numerous peacetime possibilities. It has been the testing-ground for a number of developments—especially in the greater control of electrical and mechanical action—and the future applications of the principles and innovations it con-

tains are daily increasing in scope.

It has, for instance, helped to demonstrate that it is possible to build an electrical computing network that will follow an exact mathematical formula. This principle can be adapted to any of the numerous instances in which several variables are involved that are difficult or impossible to compute by mechanical means.

Other developments came about in conjunction with it, such as the curve-plotter and a new device for winding of precision attenuators and potentiometers. The future of these, as well as the computer itself, is seen by engineers as an active one in the postwar world.

Two Fairchild engineers, Erwin H. Hale and Irving W. Doyle, are inventors of the K-8 sight. Doyle conceived the instrument, and Hale spent the ensuing years working it out.

-30-

Electronically Yours

(Continued from page 37)

neers: Maintenance and repair of electrical equipment, installation of equipment.

2. Operating engineers: Operation of generating and substations or other electrical equipment.

3. Laboratory engineers and assistants: Working under direction of engineers, they perform routine and experimental work.

4. Design engineers: This work covers design of specific apparatus for a specific purpose by making use of development and design information available.

5. Development engineer: Works with the research engineer and others to solve problems so that a specific job may be done. This work usually results in development information and a model which forms the basis of the product design.

6. Research engineer: Applies fundamental knowledge and principles to develop new techniques, solve new problems and point the way to new products, processes, etc. This advanced information is called upon by the development and design engineers.

Basic requirements for electrical engineers include a fundamental knowledge of mathematics, physics, chemistry, mechanics and materials. For a specific job in a specific field, a detailed knowledge of apparatus techniques and methods employed also is necessary. To progress in that field, there is no substitute for practical experience in addition to the required education. It is essential to have a college education or its equivalent to succeed in the electrical engineering profession, the experts agree.

The equivalent may be obtained by home study, extension courses at some university or college, or night schools.

Some general advice by the manufacturers to the soldier who wants to become an electrical engineer:

1. Carefully appraise your past education and experience and make up



War shortages crop up in strange materials. Mica, for instance. Once seen principally in the windows of stoves, and in small boys' pockets, it is now used extensively as electrical insulation. In some war products, it is virtually indispensable: capacitors for radio, spark-plugs for airplane engines, insulators in electronic tubes.

With demand mounting, manufacturers were desperate. A four-man

technical mission flew to London to help ration the world's supply between the United States and Great Britain. The shortage was serious.

The War Production Board, convinced that much mica was classified too low when judged by appearance alone, asked Bell Telephone Laboratories to develop a new method of electrical tests. The Laboratories were able to do this quickly and successfully

because of their basic knowledge and experience in this field.

The new tests were made available to manufacturers in this country and abroad—the supply of usable mica was increased 60% — and a difficult situation relieved.

Skill to do this and other war jobs is at hand in Bell Laboratories because, year after year, the Laboratories have been at work for the Bell System.

BELL TELEPHONE LABORATORIES



Exploring and inventing, devising and perfecting for our Armed Forces at war and for continued improvements and economies in telephone service.

We wish to
acquaint you with



STANWYCK R. F. COILS

and
Associated Assemblies

There is a Stanwyck coil for every application in the Radio Frequency Spectrum — coils that have met the requirements of war and which will meet your requirements when the war is won . . . Send for folder describing our line and facilities.

STANWYCK

Winding Company

NEWBURGH

NEW YORK

AVAILABLE

from
**Radio
Warehouse**



TEST LEADS

Reg. \$1.35 pr. List

50¢ Pr.

In War Stamps

LOOK AT THESE SWELL FEATURES!

Each set of Leads has color-coated cables and leads—one black, one red. Right-angle pin tips to keep wire from breaking. Six-inch probes with best kinkless, rubber-covered cables. Brother, here's a bargain!

FREE CATALOGS! Mailed to you monthly on request.

MAIL COUPON TODAY

OLSON RADIO WAREHOUSE
73-A Mill St., Akron, Ohio

Please send me _____ pairs of Test Leads at 50c per pair.
I enclose _____ in War Stamps.

NAME _____

ADDRESS _____

your mind that you are capable of studying and working for the objective you desire.

2. Select the goal you expect to achieve in, say five years, and plan systematically to reach it.

3. Determine the path you will follow to reach the particular job in the particular field of electrical engineering:

- Home study while working.
- Extension college course while working.
- College courses.

4. Do your best in each course or job, and remember that the extra effort will be remembered and rewarded by promotion.

-50-

International Short-Wave

(Continued from page 87)

p.m. daily; announced they were transmitting on 11.88, 7.3, 11.95, 15.23, and at 7:15 on 6.98. Back on the air at 8 p.m. on 7.3, 9.48, and 11.95 (announced). Moscow comes on the air and leaves with the statement, "Death to the German Invader." Berlin in the 16- and 25-meter bands heard with news in English, 9:30 a.m., with almost unbelievable power, beamed to Central, South, and North America. On 6.22, Berlin comes in quite strong in the evening, beamed to North America, with news every hour on the hour. (Hester, Illinois).

HCJB, Quito, Ecuador, 9.958, heard with very good signal, 6:30 a.m.-11:30 p.m. XEWW, Mexico City, 9.50, heard with good signal, daytime and evenings, mostly music. (Underwood, Rhode Island.)

Near 11,000, Station *Victory* 229 heard from 12:03 to 12:11 p.m. recently talking to *Victory* 263; *Victory* 229 told *Victory* 263 to let up on the guy rope on the antenna so he could hear him better. (Can anyone identify?) (Harris, Mass.)

CE1185, Santiago, Chile, heard at 1:35 a.m.

DJR, Berlin, 15.340, heard signing off at 12 noon.

ZFY, Georgetown, British Guiana, heard 6:45-8:45 a.m., 10:45 a.m.-12:45 p.m., and 3:15-8:15 p.m., relays BBC news at 6:45 (S-7). Signs off with Ted Lewis singing "Is Everybody Happy?" and then, "God Save the King." OFE, Lahti, Finland, 11.780, has English news at 9:15 p.m.; announces as "Radio Finlander" (S-6). OZF, Copenhagen, Denmark, 9.520, has English news at 8:30 p.m.; announces as "Radio Copenhagen," Nazi propaganda (S-4). SBT, Stockholm, Sweden, 15.155, heard with English news at 11 a.m. (S-7); address, "Radiotrons." HAT4, Budapest, Hungary, English program, 9-10 p.m., with English news at 9:30 p.m. Breman and Braman, Germany, on 15.150, heard with English news at 11:15 a.m., in parallel with Breman and Liepzig, 15.670. Liepzig and Essen, 15.800, has English news at 11:30 a.m.

The Japanese Quarter Hour with news of the Far East, is heard over DZD, 10.540, and DZB, 9.610, Berlin, around 10 p.m. (Cotter, Mass.)

AFHQ, Italy, 17.30, has been heard broadcasting press reports in English during mornings. HP5A, Panama City, 11.70, heard with R-8 signal, evenings. ZQI, Kingston, Jamaica, 4.70, heard around 7 p.m. (Shadid, Illinois.)

PJY, Curacao, 15.140, heard calling WRS, 11:15 a.m., woman announcer. KIO, Honolulu, 11.680, heard working KKQ, California, strong signal, 8:15 p.m. Moscow on 15.240 heard with very strong signal, news in English, 11:00 a.m. Soldatensender, Athens, Greece, 9.930, woman announcer speaking German, no English, heard at 5:30 p.m. Prahava, 9.870, speaking Czech, some English praise of United States and President Roosevelt, heard at 5:35 p.m. XGOY, Chungking, China, 9.646, heard at 12 noon, good, clear signal, announced as "The Voice of China." (Barry, N. J.)

WWV, U. S. Bureau of Standards, a good guide for checkup on calibration of receivers, is scheduled as follows: 2.5 mc., 7 p.m.-9 a.m.; 5.0 mc., continuous day and night; 10.0 mc., continuous day and night; and 15.00 mc., 7 a.m.-7 p.m. Time checks are given on the various frequencies each quarter hour, generally. (Horn, N. Y.)

London's transmitter on 2.880, listed to open at 9 p.m., is now on at 8 p.m., announced on transmission of November 30. (Yates, N. Y.)

"Debunk, Voice of All Free America," listed as on 7.195, 8:30-8:50 p.m., is now heard on 7.210, Wed., Thurs., Fri., 8:38-8:48 p.m. (De Arras, Virginia.)

Jerusalem, Palestine, on 9.670, has English news at 1:45 p.m. HVJ, Vatican City, 17.445, has English news at 11:00 a.m., Tuesdays. Berlin, DJL, 15.110, DZB, 10.042, and DXR, 11.760, has English news at 11:30 a.m. VLC7, Shepparton, Australia, has English news on 11.840, at 1:15 a.m. (Harris, Mass.)

"Sinpac," believed to be in Honolulu, heard on 7.2 mcs., about 5 a.m., transmitting "Spotlight Band" spots for Blue Network. (Woolley, Colorado.)

Moscow on 15.53 is heard on the 6:48-7:25 p.m. transmission to the United States. (Brewer, Oklahoma.)

HE04, Bern, Switzerland, 10.338, puts in a good signal, 3:45-4:15 p.m. (Weissman, New York.)

TAP, Ankara, Turkey, 9.465, heard 4:25-4:45 p.m. daily; Monday and Thursday, information about Turkey; Sundays, "Postbag" program for SWL's. DXP, Berlin, 6.03, and DXJ, 7.24, heard to North America, 5:50 p.m.-1 a.m., with news on the hour. DJD, Berlin, 11.770, heard to Africa, 11:15 a.m.-4:45 p.m., with English news at 2:15 and 4:30 p.m. VLG3, Melbourne, 11.71, and VLG4, 11.84, heard 1:10-1:45 a.m., with English news at 1:10 a.m. VLG3, 11.710, and VLC6, 9.615, heard 11:00-11:45 a.m., with English news at 11:00 a.m.

The Swiss are now using 6.165 mcs.,



CONSIDER *Signal Fidelity*

WHEN YOU SELECT A NEW TRANSMITTER

In selecting your new transmitter, consider clarity, tone, high fidelity—all basic essentials for good broadcasting. The radio audience can't possibly hear your signal any "sharper" than you send it.

The new Westinghouse Transmitters have been designed for faithful reproduction of any type of program over the entire range of frequency and percentage of modulation. Specifically:

1. *Equalized Audio Feedback System* helps to strengthen the inherent high fidelity of the audio and modulation circuits.
2. Simplified Class C circuits permit easy adjustment of transmitter for continuous, high-fidelity output.
3. Carrier noise is reduced by generous filtering and use of inverse feedback.

4. Conservative design and operation permits wide range of loading and modulation at high fidelity.

Supporting data on all these features will be furnished gladly, along with detailed facts on other Westinghouse advantages, such as: *Low Operating Cost, Simplicity of Control, Continuity of Operation, Ease of Maintenance.*

**PLACE YOUR ORDER NOW
FOR YOUR POSTWAR TRANSMITTER**

By placing your order today for a Westinghouse Transmitter, you assure yourself of the fastest possible delivery following the lifting of wartime manufacturing restrictions. We are scheduling deliveries in the sequence in which orders are received. For details, write Westinghouse Electric & Mfg. Company, Dept. 1NB, P. O. Box 868, Pittsburgh 30, Pennsylvania.

J-08077-A

Westinghouse RADIO DIVISION
PLANTS IN 25 CITIES... OFFICES EVERYWHERE



A M • E L E C T R O N I C S • F M
February, 1945 131

CUT HOLES

3/4" TO 3 1/2"



in radio chassis

Punch cuts through chassis, die supports metal to prevent distortion, cap screw is turned with wrench to cut clean, accurate holes for sockets, plugs, and other receptacles. Saves hours of work — no reaming, filing or drilling! 3/4" to 3 1/2" sizes. Get complete data now from Greenlee Tool Co., 1882 Columbia Ave., Rockford, Illinois.

WRITE FOR FREE FOLDER S-119



NATION-WIDE
MAIL ORDER
DISTRIBUTORS
SINCE 1928



RADIO AND
ELECTRONIC

DEVICES

For...

TRADE
INDUSTRY
VOCATIONAL
COMMUNICATION
PUBLIC UTILITY
and
EXPERIMENTAL
APPLICATIONS

BURSTEIN-APPLEBEE CO.
1012-14 MCGEE ST.
KANSAS CITY 6, MISSOURI

for the transmission, 9:30-11:00 p.m. nightly. (Yates, N. Y.)

* * *

FOR SOUTHWEST READERS

From Tusla, Oklahoma, Don Brewer sends us these tips for listeners in the Southwest (CWT):

The BBC's North American Service is now heard best on GSU, 7.26 mc., during the entire transmission, 4:15 p.m.-11:45 p.m., and during the latter part of the transmission over Leopoldville on 9.783 mc., 8:15-9 p.m., and 9:15-11:45 p.m.

XEWX, Mexico City, is on the air broadcasting Mexican programs from their local station, XEW, during the daylight hours. They operate on approximately 9.50 mc. Reception is very good.

CBFX, Montreal, Quebec, is heard here in English on 9.63 mc. during early mornings from 7-8 a.m. Reception is excellent. Relays CBF, Montreal.

HCJB, Quito, Ecuador, is now heard from 7 to 8 a.m. and 3-5:30 p.m. This station is off the air on Mondays at these hours. Programs are of a religious nature. On Tuesdays through Fridays, they present radio lessons of Spanish (in English). The station operates best on 12.445 mc., and reception varies, but generally is good.

Radio Brazzaville, 11.97 mc., has been coming in with poor reception quality lately on its 6:25 p.m. news broadcast.

PRL8, Rio de Janeiro, Brazil, hasn't been heard here for some weeks. This station, on 11.720 mc. formerly was one of my best "stand-bys," when I didn't want to hunt around for other stations. I presume they still are short-waving their North American program in English from 9 to 9:40 p.m. (EDITORS NOTE: PRL8 is heard 10-11 p.m. EWT).

VLC6, Shepparton, Australia, still comes in with excellent signal strength on its 7-10 a.m. broadcast, but is violently QRM'd here by a Spanish-speaking station, making the program almost unintelligible at times. The frequency is 9.615 mcs.

* * *

NEW ENGLAND REPORT

From our faithful friend, Gilbert L. Harris, of North Adams, Massachusetts, we have the following report this month:

11.635—Hungarian Nations Radio, heard Sunday, from 1:15 to 1:28 p.m.; good.

9.835—Hungarian Nations Radio, heard Sunday, from 3:15 to 3:30 p.m.

15.340—DJR, Berlin, heard with news in English at 10 a.m.; heard at 11:14 a.m. with odd music (probably African beam).

12.115—ZNR, Aden, Arabia, heard Sunday, from 11:50 a.m. to 12:01 p.m., testing with recordings. At 12:01 p.m. gave news in Arabic.

15.430—ZOY, Accra, Gold Coast, heard from 11:40 to signoff at 11:47 a.m. English announcement given just prior to signoff.

11.760—DXR, Berlin, heard at 9:30 a.m. with news in English.

9.535—JZI, Tokyo, heard at 9:35 a.m. with talk in English.

17.445—HVJ, Vatican City, heard Saturday, at 9:44 a.m. with bells ringing. Heard at 9:45 a.m. calling South Africa.

6.760—YNDS, Managua, Nicaragua, heard Saturday, at 11:06 p.m., with music.

18.080—GVO, London, heard signing off at 11:15 a.m.

21.470—GSH, London, heard Sunday, signing off at 11:30 a.m.

6.212, 7.420, 9.800, 9.930—Radio Atlantik, checked signing on at 1:30 p.m.

8.188—CNR, Rabat, Morocco, heard Sunday, at 1:49 p.m.

7.869—SUX, Cairo, Egypt, heard Sunday, at 3:24 p.m.

7.300—New Delhi, heard at 3:30 p.m. with news in English. Said "good-night" at 3:48 p.m. signoff.

11.640—Press Wireless Station heard at 10:23 a.m. calling Paris, France; still on the air at 10:47 a.m.

9.590—Berlin, heard Sunday, at 11:45 a.m. with news in English at dictation speed. At 3 p.m. heard calling Ireland as Holland and Berlin. Then had news in English.

10.005—"Voice of Free Arabs," heard Sunday, 1:15-1:30, 2:15-2:30, and 3:15-3:27 p.m.

9.990—Dakar, heard Sunday, 2:20-3:31 p.m. Music with speaking in French.

9.705—Radio Martinique, heard Sunday, signing on at 6:30 p.m.

9.32—Buenos Aires, Argentina, heard Sunday, at 8:20 p.m., with music; still on at 10:30 p.m.

6.097—German Catholic Station, heard Sunday, 4:53-5:13 p.m., 5:33-6:13 p.m., and 6:53-7:13 p.m. Church music; talking in German.

15.170—TGWA, Guatemala City, heard at 10:45 a.m.

8.550—Radio Tevere (German-controlled Italian station), heard Sunday, signing off at 8 p.m.; 40 db. above S-9.

4.105—HCJB, Quito, Ecuador, heard Sunday, at 10:13 p.m., with music.

5.620—Trujillo, Peru, heard Sunday, 10:20 p.m., with music.

6.870—Managua, Nicaragua, heard Sunday, at 11:24 p.m., with music.

6.270—Station heard at 6:15 p.m., Sunday, very weak; believed to be "Die Heimat Ruft Die Front."

* * *

ANKARA'S "POSTBAG"

Of much current interest is the series of "Postbag" broadcasts from TAP, Ankara, Turkey, 9.465 mc., on Sunday afternoons from approximately 4:25 to 4:40 p.m. These programs are directed to SWL's the world over.

Gilbert L. Harris, Massachusetts, tipped me on this one and I have been hearing it R-9 plus each Sunday afternoon lately. TAP officials are anxious to have reports from anywhere in the world, according to announcement. Recently it was announced on "Postbag" that Turkey would shortly have three new transmitters on the air. Frequencies of these stations were not given. If anyone picks them up, please

STRAIGHT TO THE MARK!



Our Navy's PT Boats are driving the war home to the enemy at high speed. They're shooting straight to the mark! They're demonstrating the power of American ingenuity and industry to the Jap war lords!

Eastern is serving on board these scrappy, hard-hitting PT Boats. Eastern equipment helps them carry out each assignment—swiftly and surely. Amplifiers, only a few short years ago, were thought of mainly in connection with sound systems. Today, they are an important part of many essential war instruments.

Eastern is proud to utilize its engineering and production facilities in the war effort . . . certain that its war-time experience will result in better-than-ever post-war sound and electronic equip-

ment. Until the victory is won, Eastern will continue to devote all its resources to the design and manufacture of war equipment. To aid the war effort, our engineers are available for consultation on any amplification problem you may have.

On request, we shall be glad to forward brochure containing the first of a series of articles covering technical phases of interest on sound amplification by Leonard A. Meyerson.

Buy MORE War Bonds



EASTERN AMPLIFIER CORPORATION

794 East 140th Street, New York 54, N. Y.

EASTERN AMPLIFIERS

For Soldering in
Tight Places . . .

DRAKE

No. 400 Soldering Iron

Smallest Industrial Iron
Ever Designed

60 Watts— $\frac{1}{4}$ in. Tip

Only 9 in. long—Wt. only 8 oz.

This mighty mite is backed by DRAKE'S 25 years of soldering iron manufacturing experience. The high quality and long service of DRAKE Soldering Irons have made them outstanding favorites with all types of radio men everywhere. The DRAKE No. 400 is an outstanding value at



Only \$4⁵⁰_{tisr}

Drake Has an Iron
for Every Purpose.
Ask Your Radio
Parts Jobber.



DRAKE ELECTRIC WORKS, INC.
3656 LINCOLN AVE., CHICAGO 13, ILL.

For Radio
as you want it!

We're still up to our ears
in critical war work but
when the war's won we
will again be ready

. . . To DESIGN, DEVELOP
and MANUFACTURE . . .

Radio Receivers and Transmitters
Industrial Electronic Equipment
Airport Radio Control Equipment
Marine Radio Telephone Equipment

Your inquiries will receive immediate action

ISLIP RADIO MFG.
CORPORATION

ISLIP, L. I., NEW YORK

let me know. In the meantime we have written for full information on this proposed expansion of short-wave service.

* * *

COSTA RICA STATION LIST

We have just received the following list of short-wave broadcasting stations in Costa Rica from the *Direccion General de Telegrafos y Radios Nacionales*, giving call letters, frequencies, power, station name (identification), owner, and location:

TI-GPH, 5.875 mc., 1,000 w., "Alma Tica," Gonzalo Pinto H., San Jose.

TI-RH, 6.150 mc., 250 w., "Radio el Mundo," Rafael Hine Ch., San Jose.

TI-LS, 6.165 mc., 2,000 w., "Para Ti," Luis Saenz Mata, San Jose.

TI-RCC, 6.180 mc., 300 w., "Accion Catolica," Prbo. Carlos Borge, San Jose.

TI-EP, 6.700 mc., 1,000 w., "La Voz del Tropico," Eduardo Pinto H., San Jose.

TI-PG, 9.615 mc., 2,000 w., "La Voz de la Victor," Claudia Martinez N., San Jose.

TI-NRH, 9.692 mc., 750 w., "La Voz de Costa Rica," Amando Cespedes Maria.

The best-known stations in Costa Rica, of course, are those operated by Senor Amando Cespedes Maria, TI-NRH, on 9.692 mc., and the broadcast band station, T14-NRH, on 710 kilocycles. A verification from T4-NRH was much prized in the "good old days" of early radio broadcasting, you will recall.

In the broadcast band, Costa Rica now has in operation 24 stations from 575 to 1,200 kilocycles, inclusive, with powers ranging from 400 to 8,000 watts. (If anyone would like a complete list of these Costa Rica broadcast band stations, please write me.)

* * *

WATCH FOR DUTCH STATION

You should be on the lookout for broadcasts from The Netherlands short-wave station as that country is liberated from the Nazi yoke. An interesting story has come to us about how the new Dutch long-wave radio station, *Nerrijzend Nederland* (Resurgent Netherlands) was built secretly, piece by piece, "under the very eyes of the Germans" in different parts of occupied Holland.

The story was recently related by Frank Gillard, BBC correspondent, who reported that a group of Dutch patriots early last year had begun to build the transmitter, which broadcast from liberated Holland for the first time on October 3, 1944, in order "to have a radio station ready to go on the air as soon as the Allies reached Dutch territory."

"Through 18 months of occupation, under the very eyes of the Germans the work went on," he said.

"Three men were given the job of constructing a transmitter which would be powerful enough to cover the whole of Holland and be adequate for the job. They drew up their plans. Everything had to be done with great secrecy. The transmitter was to be

built in sections at scattered points, and then when the great day came the sections could be put together and free Holland could go on the air."

The Netherlands Government in London was informed of the plan by secret messages, Gillard said, and at the end of September, when a substantial part of Holland had been liberated, the different sections of the transmitter were assembled, an aerial was strung "between two chimneys," and *Nerrijzend Nederland* began a regular program service which can now be heard throughout Holland.

According to the best information we can obtain, the Germans still control the powerful short-wave voice of Huizen, but watch for the voice of a free Holland in the popular short-wave bands this spring!

* * *

REPORTS FROM READERS

(EWT, unless otherwise indicated herein.)

TEXAS—Ralph E. Dahm, San Antonio, Texas, using a Philco 116-B, says London comes in "fair;" Berlin, "poor;" Tokyo, "good;" Moscow, "good;" Brazzaville and Leopoldville, "good;" Australia, "good;" and Djar-karta, "good."

WEST VIRGINIA—Charlie Gonder, a student at West Virginia University, Morgantown, West Virginia, reports:

The European Service of the BBC on approximately 7.45 mcs. is heard well from 5:45 to 6 p.m., with identification in drumbeats. The North American Service comes in well on all frequencies, evenings.

HP5K, 6.005, Panama Broadcasting Company, Colon, Panama, is heard with news in English at 11 p.m.

9.445—Brazzaville, French Equatorial Africa, pounds in from 6:30 to 7:45 p.m., with news in French for Canada at 7 p.m., and news in English for the United States at 7:25 p.m.

9.55—Radio Shonan, Singapore, heard in Japanese recently at 10:30 a.m.

11.72—Winnipeg, Manitoba, Canada, is heard well during the daytime and early evenings. Has news in English at 1:15 p.m.

11.737—COCY, Havana, pounds in here during the evenings. Signoff is usually at midnight.

11.897—Radio Tokyo is heard with a signal of great power these days, 6:15-8:15 p.m., with news in English at 6:20 and 7:20 p.m.

CALIFORNIA—Lt. William T. De Van, ASF Regional Hospital, Fort Ord, California, writes that he has been receiving Leopoldville, Havana, Tokyo, Voice of the Pacific Fleet, Rio de Janeiro, Australia, and Berlin, but finds the announcers "loathe to give station call letters."

FLORIDA—From Tampa, Florida, Bill Britton reports the following stations:

11.93, 9.825, 9.69, 11.68, London, weak to excellent, early evenings, and sometimes to 11 p.m.

9.615—VLC6, Australia, 8-8:45 a.m., good sometimes, but splashed badly by South Americans.

Famous ON BOTH
Hemispheres



**INDISPENSABLE
IN WAR**

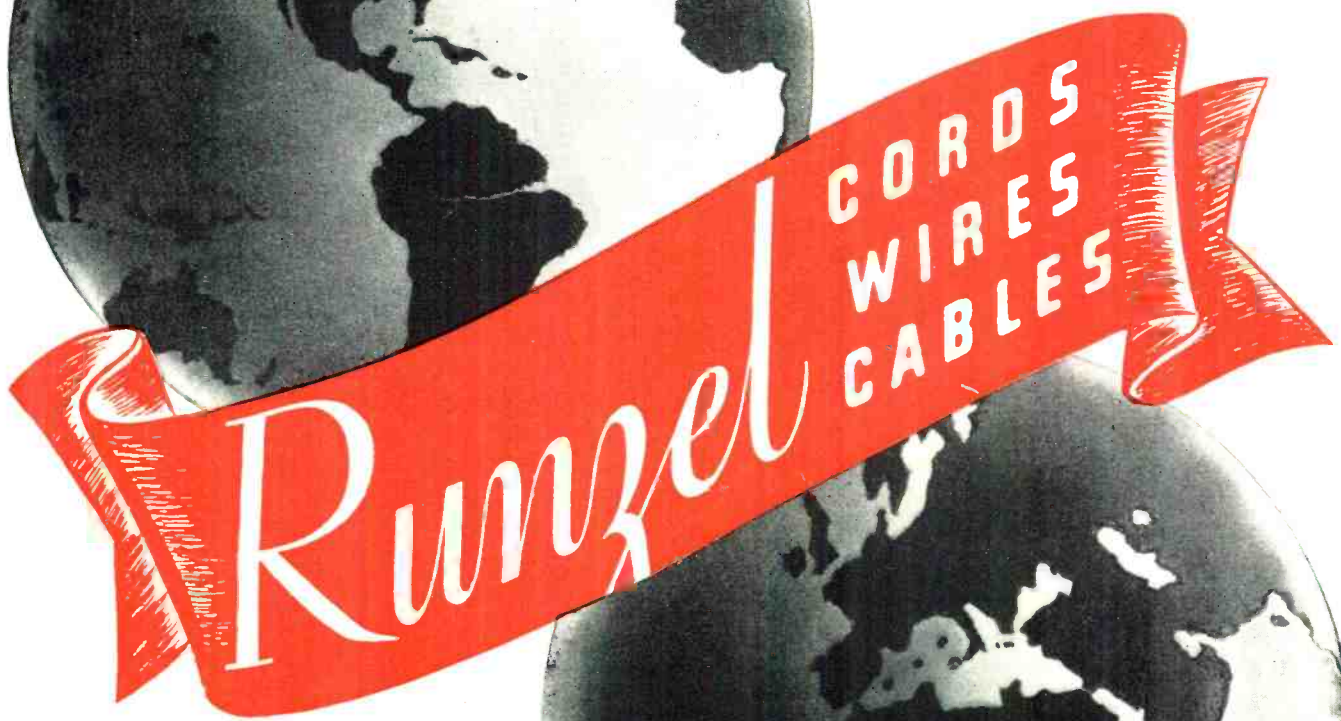

**A
PEACETIME
NECESSITY**



RUNZEL CORD & WIRE CO.
4723-31 MONTROSE AVENUE • CHICAGO 41

110-VOLTS AC from DIRECT CURRENT

with KATO KONVERTERS. Furnish standard 110-volt AC from 32, 110, or 220-volts DC. Good deliveries on sizes 350 through 1500 watts.

PIONEERS IN THE BUILDING
OF SMALL ROTARY CONVERTERS

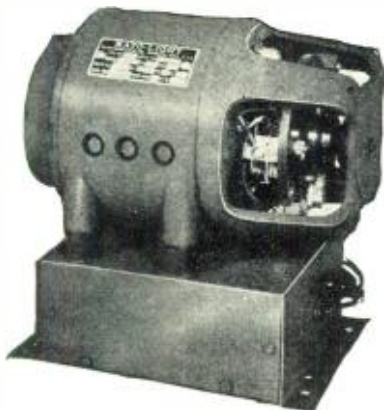

Katolight Rotary Konverter, 225 Watt

Good deliveries on 5, 7½, 15 and 25 KW AC generators. Mfg.'s DC generators, motor generators, frequency changers, high frequency generators.

Kato's entire production at present must be confined to orders with priorities.

KATO ENGINEERING CO.
120 Rock Street Mankato, Minnesota

Rugged!



PAPER
and
ELECTROLYTIC

CAPACITORS

Dependability is a MUST. The rugged, durable Illinois Capacitors give you maximum satisfaction under the severest of operating conditions. When looking for "tough" condensers that can be relied upon, choose "ILLINOIS."

ILLINOIS CONDENSER
COMPANY

1160 NORTH HOWE STREET
CHICAGO 10, ILLINOIS

11.77—DJD, Berlin, heard 4:15-midnight, fair.

10.543—Berlin, heard 5:55 p.m.-midnight, weak. (Believed to be Latin American Service.)

9.865—Madrid, 6-7:15 p.m., good.

10.338—Bern, Switzerland, 3:45-4:15 p.m., was good, but now rather weak.

9.539—Bern, Switzerland, 9:30-11 p.m., good.

11.725—Radio Tokyo, 9 a.m.-noon, good.

* * *

ACKNOWLEDGMENT

Thanks for all reports received this month. We are sorry we cannot print all of them due to space limitations, but please keep them coming as they are always helpful. Address: Kenneth R. Boord, % RADIO NEWS, 540 No. Michigan Ave., Chicago 11, Illinois.

—30—

QTC

(Continued from page 60)

positions both aloft and aground in the postwar aviation boom. Tax rates for some outfits are doubled up for the same properties because each state, as well as the Federal government, can tax them under present regulations. A recent proposed federal law will give the federal government exclusive control over all air traffic, which is as it should be; airways traffic is too national and international in scope to be governed by each state and control for traffic of this type should be under the federal government in the same manner that radio communications are governed . . . there would be a nice mess if we had each state making radio laws.

FEDERAL Telephone and Radio Corporation is getting a new television transmitter for Columbia Broadcasting System which will transmit both sight and sound on a single carrier. The new outfit will be located atop the Chrysler Tower in New York City and will broadcast the programs from studios of WCBW at Grand Central Terminal. Most of you in television will appreciate what this means in simplified design, reduced cost due to necessity of only one transmitter instead of two, and reduction in total number of tubes necessary. Additional stations, with the new type equipment brought out recently, will be installed in other key points by CBS before long, it is believed.

To go along with WNBTV, the NBC television station in New York, NBC has filed for permits to construct stations in Cleveland, Chicago, Denver, San Francisco, and Los Angeles. New FM stations also will be placed in operation at points where the network maintains studios.

SOME of the marine coastal stations which have been closed for some time are expected to reopen shortly; business is picking up. Things

are still busy in various ports along the east coast with shipping still good . . . and U. S. Maritime still looking for men. The radio operator situation seems to be as usual—not enough men to go around for the three-men-to-a-ship regulations which have been in effect nearly a year now. Although Allied and Neutral nations lost 5,758 ships from the start of the war to the end of 1943, and the U. S. Merchant Fleet lost 767 ships, the construction of new ships by the Allied nations has far overcome this loss. U. S. construction alone has nearly replaced those lost. Very few ships have been lost since last year, the serious time being back in 1942.

Men of the Navy and Coast Guard who have been disqualified for some physical disability have been asked to enter the merchant marine by the USES to relieve the present shortages in the merchant fleet. Men with 18 months deck or engine experience can take exams for third mate or third assistant engineer.

ACA's Harry Morgan has appeared before WLB, dickering for a National Master Agreement to cover all ships and companies in place of making an individual agreement with each outfit and also trying to straighten out the wage situation. The boys on the ships have a base pay of about three quarters or two thirds what a radio operator gets ashore and the airways pay nearly twice what a marine man gets, so maybe that accounts for some of the boys going into aviation.

HAVE a recent letter from D. D. Bulkley requesting some dope on stations that send out press addressed to c.q. and also asking for some of the other stations sending regular press schedules that he may use for code practice. Can any of you assist with the above? We have already forwarded what information we have on hand but believe that some of you can furnish much more complete information. Thanks. 73.

—30—

Spot News

(Continued from page 18)

multiplexing system. Here facsimile could be multiplexed on transmitting maps, storm warnings, barometric readings, wind velocity and direction, ceilings, and other data which is reduced to permanent records. Marine services would find the system useful, too, he explained. They could use it for maps, charts, diagrams, etc. Mr. Payne also stressed the educational field, stating that facsimile provides a blackboard for every home and classroom.

Testimony of A. W. Norton and D. K. DeNeuf of Press Wireless revealed that a large increase in public service facsimile is expected. The im-

portance of the service, particularly in transmitting foreign language code and characters such as Chinese, Persian, and Turkish, was stressed. These experts also pointed out that facsimile can deliver intelligence in terms of ordinary English text at rates of more than 1000 words a minute. Commenting on this speed factor, Mr. Hogan said that no other method of communications can transfer ideas from one point of our world to another at any such speed.

Reporting for the Government, C. M. Braum, chief of the nonstandard broadcast application section in the broadcast division of the FCC, said that experimental facsimile broadcasting began in 1928. And from that date to 1939, the FCC had allocated frequencies between 1500 and 2950 kilocycles for these tests. In April, 1939, the frequency schedule was changed to include 25,025 to 25,250 kc.; 43,540 to 43,940 kc.; 116,110 to 116,470 kc., and any frequency above 300,000 kilocycles, except the band of 400,000 to 401,000 kc. In 1940, two of these bands, 43 and 116 megacycles, were reassigned to other services. There are now three experimental facsimile broadcast stations operating in a ten-channel 25-megacycle band from 25,025 to 25,250 megacycles. These are W9XWT, the Courier-Journal and Louisville Times Company; WBNS, Columbus, Ohio; and WOKO, Albany, N. Y. Mr. Hogan has a special license to transmit in the 43 to 50 megacycle band on FM with 1000-watts of power. The other stations' power are 1000 and 500 watts.

The many stations who had experimented with facsimile are expected to renew their interest and request new licenses.

One railroad has already tried facsimile from a station to a moving train and reported excellent results. The railroad . . . Chicago, Rock Island and Pacific. Messages were sent from the station on Blue Island to a 12-car freight train en route to Kansas City. The recording instrument was located in the caboose. The key message transmitted lauded the progress of radio, and indicated that facsimile is further evidence of American leadership in the art of communications.

A WALKIE-TALKIE SERVED TO PREVENT extensive loss of life and property during a recent fire in New York City. A fireman in a burning building notified those below through the walkie-talkie that highly inflammable materials stored in lofts nearby would be ignited if additional water and auxiliary pumping equipment were not put into action immediately. Not only was the water power supplied, but an additional alarm was sounded bringing the requested auxiliary equipment. The flames were brought under full control, and kept away from the inflammable material. During the year, fire department officials found the walkie-talkie to be

Don't Let The Light Weight Fool You! Only 14 Ozs. But **225** Watts Power

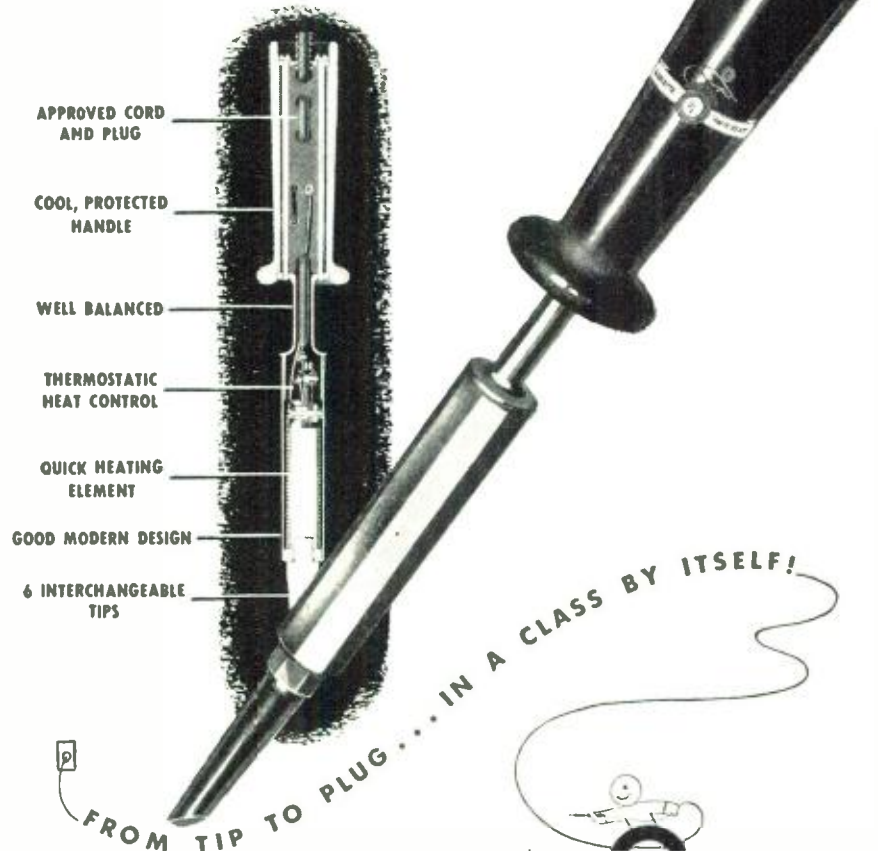

Only the Vanatta Kwikheat has...

Built-in Thermostatic Heat Control...HOT IN 90 SECONDS

—Built-in thermostat keeps the Kwikheat Iron at correct temperature for most efficient work—can't overheat—saves re-tinning time. It will do jobs of several ordinary irons and do them better! Check these exclusive advantages that put the Vanatta Kwikheat Soldering Iron in a class by itself . . . it's *HOT*, ready to use only 90 seconds after plugging in . . . saves time. Powerful, 225 watts, yet it's light (14 ozs.)—well-balanced. Cool—safe—protected handle. Six interchangeable tip designs enable one iron to do most any soldering job.

Ideal for radio or telephone work. Thousands of Kwikheat Irons in use by some of largest precision manufacturers in nation. Order your Kwikheat Soldering Iron and extra tip styles today from your distributor. Complete iron \$11.00 list, includes choice of #0, #1, #2 or #3 tips. AA5, or better, priority required.



- #0—\$1.25
- #1—\$1.25
- #2—\$1.25
- #3—\$1.25
- #4—\$1.75
- #5, Melting pot for tinning—\$1.50



A PERMANENT MAGNET UNIT



This famous MODEL 7 permanent magnet driver unit is ideal for most high-power sound projection installations. The unique magnetic structure em-

loys a central cone-shaped magnet of ALNICO, weighing 3 lbs. 4 oz. with a flux strength of 12,000 gauss in the magnetic gap. Will not depreciate in strength through shocks nor ageing. Specifications: 16 ohms impedance; 18 to 20 watts continuous duty.

If you have an idea or a problem we offer you these facilities:

- Development
- Design
- Engineering
- Precision Manufacturing
- Marketing

*Your Post War Inquiries Invited.

ROWE Industries

ELECTRONICS DIVISION

3120 Monroe Street, Toledo 6, Ohio

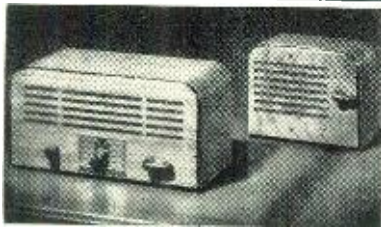

Talk-A-Phone

The World's Most Complete
Line of Inter-Communication
"Has Everything"

Everything the most discriminating eye for beauty could desire in modern styling. Everything advanced electronic engineering skill and ingenuity are capable of producing in inter-communication that continuously meets the most rigid requirements of convenient, efficient, care-free, economical operation in large or small organizations . . . a unit for every need.

Don't be satisfied with anything less than "Everything." See your jobber for details.

TALK-A-PHONE MFG. COMPANY

1512 S. Pulaski Road, Chicago 7, Ill.

an invaluable aid in fire fighting, saving many lives, and a substantial amount of property, and also accelerating fire extinguishing.

THE NEW YEAR SAW MANY station shifts in the networks. The Blue network gained quite a few new members, which included 5000-watt KRNT of Des Moines; 5000-watt WPDQ, Jacksonville, Florida; 5000-watt WLAW, Lawrence, Mass.; and 10,000-watt WFTL of Miami, Florida. These new affiliates provide the Blue network with a total of 193 stations. The CBS network also has grown. There are now 152 stations in its system. Recent additions include: KOTA, Rapid City, South Dakota; KGKY, Scottsbluff, Nebraska; KTYW, Yakima, Washington; and WJEF, Grand Rapids, Michigan.

For a time, it appeared as if a new network would enter the broadcasting scene: the Cowles system. However, Gardner Cowles, Jr., president of the Cowles Broadcasting Company, declared at a sales meeting that they were not interested in starting any new network. They were purchasing stations in strategic locations, he admitted, but only to provide substantial local coverage. Links will be provided if the advertiser desires simultaneous coverage, pointed out Mr. Cowles. Describing their future plans, Mr. Cowles said that they expect to operate stations in Boston, New York, Washington, Minneapolis, Yankton, S. D., and Des Moines. FM will be featured in most instances. Former FCC Commissioner T. A. M. Craven is executive vice president, in charge of engineering for the Cowles interests.

TELEVISION

A BARRAGE OF COMPLEX QUESTIONS fired at television experts who appeared at a round-table session during the recent Television Broadcasters Association conference in New York City, provided many intriguing and informative replies. Questions asked covered the use of 16-mm. film, color, antennas, studios, program hours, coaxial cable and telephone wires for transmission, lineage, ghosts, and projection. Participating on the answering panel were: O. B. Hanson, NBC; J. E. Keister, GE; Dr. Allen B. Du Mont; Dr. C. B. Joliffe, RCA; F. J. Bingley, Philco; A. H. Broly, Balaban and Katz; Klaus Landsberg, Television Productions (Paramount Pictures); C. W. Mason, Earle C. Anthony, Inc.; and Dr. Alfred N. Goldsmith, who acted as moderator.

Answering the 16-mm. question, Dr. Du Mont said that there is a need for improved equipment to provide recording of sight and sound. The film is very useful, he said, and every effort should be made to increase its efficiency. The industry needs a satisfactory 16-mm. station projector, too, he said. Other experts agreed with Dr. Du Mont on the value of 16-mm. film for television, adding that such

film would be ideal for the small television station owner, who could buy packaged shows and dispense with the expensive coaxial cables or relay links. Such a procedure would eliminate the timeliness virtue of the showing, but for certain periods of the day, this practice would not be too injurious, declared some of the specialists.

The delicate question of color was answered by O. B. Hanson, who said that color transmission and reception will not be practical for at least eight to ten years. He pointed out that all problems on the present black and white transmission on 6-megacycle bands should be solved first. Coaxial cables also will have to be improved to allow for wide-band transmission which color requires. Production problems are also acute in color work. Mr. Bingley said that color will not be available for a long, long time.

An interesting question on lineage inquiring into the history of increased multiple lines, particularly 525 lines, prompted a reply by Dr. Du Mont. He said that the Du Mont labs had experimented with high-definition pictures as far back as 1931, when they transmitted 735-line scenes. No improvements were noted, for as far as the lineage was increased, the peak of transmission and reception efficiency appeared to diminish. Receiver complexities also prompted many problems, such as involved sweep circuits. Ghosts also increased in appearance as the lineage was increased, Dr. Du Mont indicated. Dr. Joliffe added that they had studied increased line transmission and found that 735- to 1000-line transmission is a compromise between economy and practical transmission. More lines do not solve all the problems, he said.

Studio size questions were answered by O. B. Hanson and Dr. Du Mont. Mr. Hanson said that the studio should be very large, perhaps 25 feet in height, 40 feet wide, and 70 to 90 feet long. Such a studio would permit flexibility of action, better lighting, more room for substantial sets and better acoustic control. Dr. Du Mont preferred several separate studios to permit rehearsals, particularly for the benefit of prospective sponsors.

The use of telephone lines for television-signal transmission was discussed by F. J. Bingley and O. B. Hanson. Mr. Bingley did not look too favorably on the method. He said that many narrow-band systems for wide-band transmission have been conceived, but none proved practical. Mr. Hanson reported that transmission over telephone wires is practical, however, over limited distances. NBC has used telephone wire links over 1 to 4 miles quite effectively. Longer lengths of circuits would require too many repeaters, which would make the system quite costly and impractical, he said.

Projection received an interesting analysis by the panel members, too. Dr. Joliffe reported that the 525-line pictures are adequate for projection.

"Make it a Stromberg-Carlson for the main radio in your home."

That's the story that Stromberg-Carlson is currently telling to your post-war radio prospects through 475,000,000 impressions in leading magazines.

This is far more than just a 'sales story.' It's a basis for a very sound sales policy for you and for us, alike. For, since the main radio in any home should be as good a radio as the purchaser can buy—a true quality musical instrument—and, since there's nothing finer than a Stromberg-Carlson, it stands to reason that thousands of Stromberg-Carlsons are slated to fill that spot marked

"X" in thousands of homes of every type.

So plan your merchandising about this theme, and remember that Stromberg-Carlson is:

- the *important* radio unit
- the radio unit carrying real *profit-opportunity*
- the radio unit with easy-selling *public acceptance*

Organize your post-war sales around this potent Stromberg-Carlson sales theme. You'll find the Stromberg-Carlson "*main radio*" a consistent profit maker—whether in an outstanding table model, console, or radio-phonograph combination.

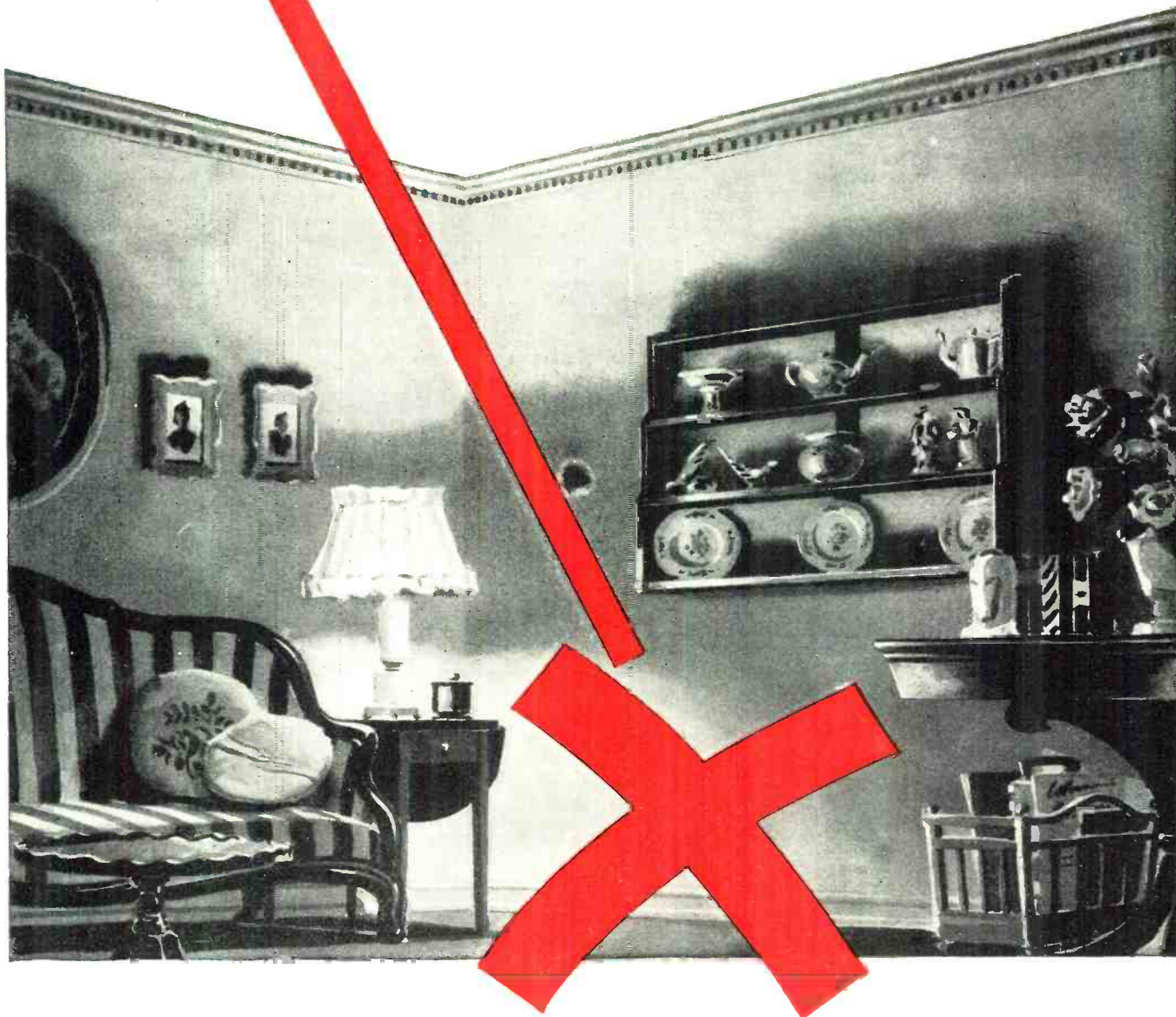

"X" MARKS THE SPOT

make it a

STROMBERG-CARLSON

ROCHESTER 3, NEW YORK

RADIOS, TELEVISION, TELEPHONES, AND SOUND EQUIPMENT

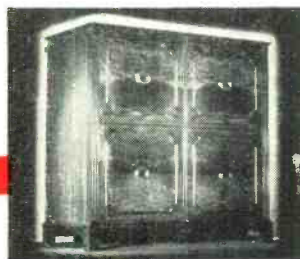

for the main radio

in your home!

LECTROHM ADJUSTABLE WIRE WOUND • VITREOUS ENAMELED RESISTORS

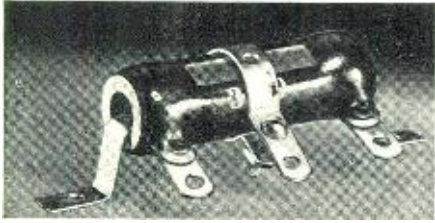

Experience built
under personalized supervision

Lectrohm adjustable Resistors are a precision product. Resistance wire is silver soldered to the solder lugs by special process, assuring perfect electrical bond always. A thorough vitreous enamel coating completely embeds the accurately spaced winding, terminals and silver soldered connection—producing a solid, integral unit. These Resistors are used as voltage dividers, or potentiometers and can be equipped with several adjustable bands. Capacities 10 watt to 200 watt. Request complete information.



5131 West 25th Street, Cicero 50, Illinois

MASTER THE CODE with MASTER TELEPLEX



All A. C. operated. The only all-in-one instrument that will record your own sending and repeat it back.

Records signals from the

air and repeats back at any speed.

The perfect instructor for both sending and receiving.

A postcard will bring full details and how you may secure MASTER TELEPLEX for ten day free trial. Ask for Booklet Q 12.

TELEPLEX CO. 107 Hudson St.
Jersey City 2, N. J.

FILMGRAPH
"MILES AHEAD OF OTHERS"

Miles Filmgraph Recorder-Reproducer affords instantaneous recordings and playback of speeches, interviews, dictation, verbal agreements and many useful functions. Write for Bulletin and further details.

MILES REPRODUCER CO., Inc.
812 Broadway (Dept. RN-2) New York 3

Radio Servicemen: RADIO PARTS—TUBES

BARGAIN PRICES—NO PRIORITIES

King P.M. Speakers, 4 or 5 inch.....	\$1.19
King 450 Ohm Speakers, 4 or 5 inch.....	1.49
Filter Cond., 20-25 Mfd., 150 V.....	.39
By-Pass Cond., .05 or .1 Mfd., 600 V.....	.07

Write Today for Bargain Bulletin
RADIO DISTRIBUTING COMPANY
P.O. Box 497—PASADENA 18, California

He pointed out that in 1940, a 440-line picture was enlarged to 12 by 15 feet at the New Yorker theater, with satisfactory results. The present systems will provide an exceptionally bright picture on an 18 x 24 inch translucent screen, he pointed out. A modification of the Schmidt optical system used in 1940 has been adopted for the new system. The image will be bright enough to view in a moderately lighted room.

Answering a question on the properties of the very-high frequencies for television, J. E. Keister pointed out since very-high frequencies are very directional, an expensive directive antenna array would be necessary to not only receive signals from a variety of directions, but to avoid ghosts. If the antenna were directed at the station, ghosts probably could be minimized, he said. But this would require some form of antenna switching. Klaus Landsberg reported that impedance matching is critical at the very-high frequencies. The lead-in wire would require special treatment in its installation, a treatment that might be costly and difficult in large apartment buildings.

NEW OFFICERS WERE ELECTED

at the close of the TBA conference. J. R. Poppele, chief engineer of WOR, was named president, succeeding Dr. Allen B. Du Mont, who becomes a member of the board. Robert L. Gibson, assistant to the vice president, in charge of advertising and publicity at General Electric was elected vice president. O. B. Hanson, chief engineer of NBC, was named assistant secretary-treasurer. Will Baltin was re-elected secretary-treasurer. Serving on the board are J. R. Poppele, Curtis W. Mason, and F. J. Bingley.

Achievement awards were given to Lloyd Espenschied, Bell Telephone Laboratories; P. T. Farnsworth (accepted by Ray Cummings of Farnsworth); Dr. Peter Goldmark, CBS; Dr. Vladimir K. Zworykin, RCA; Dr. Allen B. Du Mont; Brigadier General David Sarnoff; David B. Smith, Philco; Dr. A. N. Goldsmith; and Dr. W. R. G. Baker, General Electric. Stations WABD, WNBTV, WRGB, WPTZ, WCBW, and W6XYZ were also award winners.

Personals . . .

Dr. Ernst Fredrik Werner Alexanderson, consulting engineer at General Electric and inventor of the famed Alexanderson alternator, has won the Edison medal for 1944. The presentation was made in a joint session of the IRE and AIEE in January. . . . **Theodore C. Streibert** has become president of WOR, succeeding **Alfred J. McCosker**, who became chairman of the board. **Jack I. Straus**, president of R. H. Macy, resigned his post as chairman of the board. . . . **Murray Crosby**, inventor of the FM Crosby Circuit, has become a consulting engineer for Press Wireless. He was formerly

a research engineer for the communications divisions of RCA Laboratories at Riverhead, Long Island. . . . **Brigadier General Frank E. Stoner** has become a Major General, and **Colonel David Sarnoff** is now a Brigadier General. General Stoner is chief of the Army Communications Service. General Sarnoff has been serving the Army in a special consulting capacity. He received the Legion of Merit for his services in reopening of communications in Paris. . . . **Leon Golder**, formerly of Rola, has joined General Instruments as manager of a speaker division, which will be known as the General Electronic Apparatus Corporation. . . . **D. Martin** has become chief engineer of Wilcox Gay Corporation. . . . **Arnold Peterson** is now an applications engineer at United Electronics. . . . **D. H. Miller**, president of Speer Carbon, died recently. . . . **Raymond Soward** has rejoined Supreme Instruments Corporation. He is now chief engineer. **Robert H. Streeter** also is now with Supreme as a design engineer. . . . **Louis G. Pacent, Jr.**, son of Louis G. Pacent of the Pacent Engineering Corporation, has been named head of the industrial engineering department of Emerson Radio.

-50-

Let's Talk Shop (Continued from page 51)

radio sets. This arrangement can be made, but it does involve additional bookkeeping and is frowned upon in most cases. Most dealers will want to supply their own tubes to the serviceman for the repair of their own customers' sets. This should be considered as part of the sales and commission on their sale and is due the serviceman.

There should be a flat charge for installation of new radio sets done for the dealer. If further installation has been made for which the customer is charged, then the usual discount arrangement between the dealer and the serviceman applies.

Auto Installation

Another large part of your wholesale business should be the installation of auto receivers for auto dealers as well as retail radio dealers. There are two ways in which to do this—in the dealer's place of business which in all cases is to be frowned upon since you have to use portable equipment and installations take longer and are not as profitable. The preferred way to handle this is to do the work in your own place of business. If you are going to have any amount of volume of auto installations, you must make arrangements suitable for this work. You should also have a trained man who does nothing but auto installation and repair. You will find that the average serviceman that you hire will waste more time if he is

inexperienced with auto servicing than on any other job you can give him.

You will also find that generally the manufacturer of automobiles has specified in his price manual to the auto dealer, the amount of money which should be allowed for auto radio installation. You will be able to do the job for this amount of money, provided as noted above, you have an efficient, well-trained installation crew. In other cases, you will find automobile dealers with no cost knowledge about the installation of auto radios, and you should then arrange to make price agreements with him based upon the actual time and materials needed for complete installation.

The above remarks outline in some detail the major considerations of a wholesale operation. Generally speaking, the greatest danger is occasioned by a drop in volume of the number of repair jobs which are available at any time throughout the year. Under operating conditions before the war, as most of you know, a drop in the volume of repairs could be expected during the summer months. By using auto radio installations and repairs, it was found that the volume of business could be maintained. However, this is not enough and you should consider using all means of sales promotion at your command throughout the year in order to maintain volume.

Since most servicemen do not have sufficiently large capital structure to permit carrying a large number of employees on the payroll in times of slack business, this represents a very real danger to the operation. Store traffic is not important in the wholesale business operation since obviously most of your work will be done over the phone and by contact with the individual dealer. Therefore, it is not necessary to maintain a large imposing salesroom at a consequently large expense in this type of operation. Space does not permit the elaboration of more complete details. If any of our readers have any further questions, we would be glad to help answer them.

.....J. M.

Multi-Band Transmitter

(Continued from page 50)

ing output on high crystal harmonics, this can be avoided without sacrificing desirable simplicity by buying a couple of extra, high-frequency crystals—a cleaner, cheaper, surer course than loading oneself down with a long string of frequency-doubling stages making for complexity and bother—not to mention greater strain on the pocket-nerve.

A companion receiver exists, 8" by 5" by 3½", superheterodyne, single-signal, 1750 through 30,000 kc. It is hoped that it may be described and illustrated in a future article—that the data here presented may prove of interest to currently aching-to-be-active amateurs.

-50-

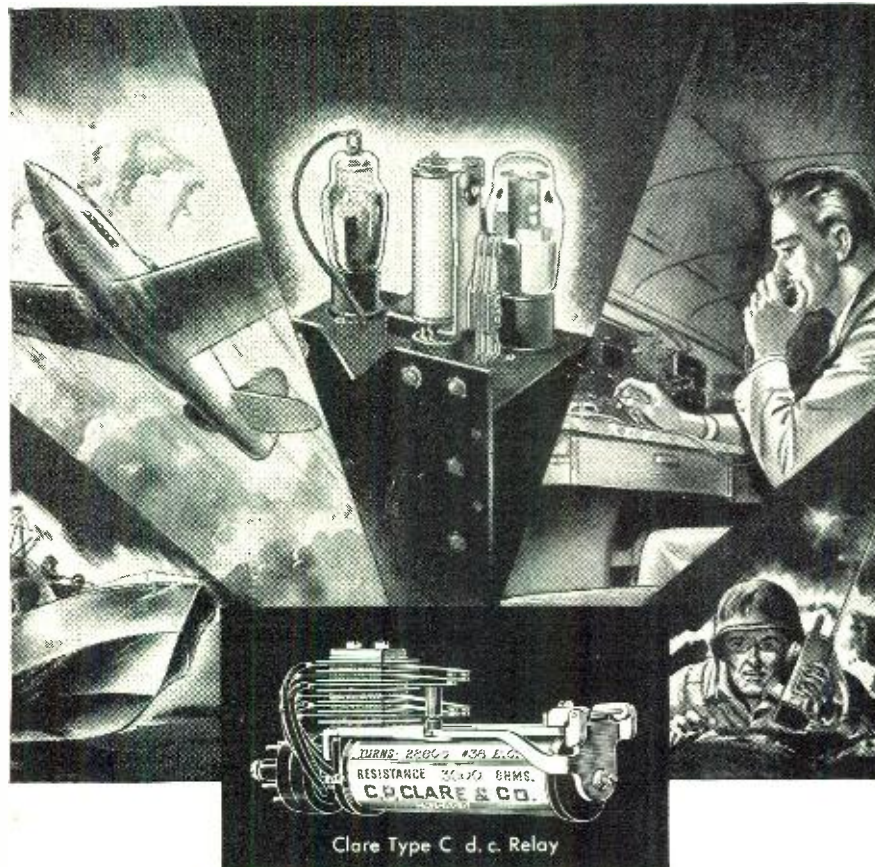

Clare Type C d. c. Relay

IT TAKES CLARE "Custom-Building" TO MEET TODAY'S DIVERSITY OF RELAY REQUIREMENTS

Clare Relays are being specified by radio engineers with increasing frequency because Clare "Custom-Building" gives them the flexibility of design that meets almost every relay problem.

Illustrated here is the Clare Type "C" d.c. relay with plug-in mounting which is especially designed for requirements that call for rapid opening and closing of circuits. The Type "C" may be used for control of up to 12 circuits.

Clare "Custom-Building" makes possible the use of the widest range of contact ratings; a choice of five different contact forms or any combination of them; either flat or hemispherical contacts of rare metals or

special alloys. It gives coil windings to match the circuit and application, the contact closure sequence and desired contact pressures.

Clare Relays are well known for their careful design and precise manufacture from the finest materials. They come to you accurately adjusted and with an adjustment that stands up under severe usage. Clare engineers are ready to "custom-build" a relay to your exact requirements. Let us know your problem and receive our suggestions. Send for the Clare catalog and data book. Write C. P. Clare and Co., 4719 West Sunnyside Avenue, Chicago (30), Illinois. Sales engineers in all principal cities. Cable address: CLARELAY.



"Custom-Built" Multiple Contact Relays for Electrical, Electronic and Industrial Use

CLARE RELAYS

Easy to Erect



MASTS AND TOWERS

Catalog will be sent to engineers and executives writing on their business letter head.

Address Dept. AP
HARCO
 STEEL
 CONSTRUCTION CO.
 Elizabeth 4, N. J.

Tone Control Circuits

(Continued from page 43)

o'clock, to accept pointer-knob set screws. A convenient ground for the bass cutoff control is a shakeproof lug of the type usually furnished to fit over volume-control shanks. To this lug can also be grounded the shields of the input and output lines.

Testing

Install the equalizer between record player and amplifier, set its controls all the way right, and turn on the system. If no unusual hum appears as the amplifier warms up, rub the needle point of the pickup with your finger to test for a signal; if no sound comes from the speaker when the needle is agitated, look for a ground between the audio line and its shield—inside the equalizer, at connectors—or at a connection to the wrong (left-hand) side of the bass cutoff resistance. This last may be checked by rotating the control counterclockwise, and again testing at the pickup. If the signal now carries through to the speaker, change the bass cutoff ground to the control's other end terminal.

If noticeable or excessive hum appears when the tubes warm up, a break may exist in shield or line, or hum is being picked up by an unshielded portion of the line. Often if the phono motor frame is not grounded to the shield of the pickup line, hum from a.c. wiring in the motor is induced along unshielded line underneath the shell of the pickup arm, and may become stronger when the pickup is handled, especially when an ungrounded pickup and its cartridge shell are connected to the audio line by mistake. Hum through which signals still may be heard occurs most often at an exposed section of line outside the amplifier chassis, and an unprotected inch or two in a high-gain system can produce enough induced hum to be noticeable through music being reproduced at the same time. Tracing and eliminating hum calls for considerable patience and for ingenuity in producing a continuous shield.

A very loud hum, through which no signal from the pickup is transmitted, requires testing of all audio lines and connections for a break. Since voltage in the pickup circuit is very low, any weak connection easily may have too high a gap-resistance to conduct such "no-voltage" currents.

Testing Operation of Controls

Turn the equalizer controls all the way to the left and start a record on the player. Turn the bass cutoff right until sound appears, and as you continue with this control, adjust volume on the amplifier to a fairly high level. As the bass control reaches its maximum position, turn up the volume until the bass begins to distort or boom, then try cutting out bass to a satisfactory listening level by returning the cutoff slowly toward the left. The

effect should be distinctly audible, and if no change occurs during this adjustment, or the control traverses its entire range without effect on the over-all volume, a break exists within the control or at its ground connection. Blind spots along the resistance will produce sudden increases of volume when the cutoff is set to include the higher frequencies, and a control having such spots should be replaced.

Leaving the bass cutoff turned to the right, advance the series load of the filter in the same direction. High notes should weaken considerably until they become relatively inaudible against the bass when the series load is at its maximum of 5 megohms. Now advance the condenser by-pass to the right. Each change should produce a greater proportion of highs. If a step value decreases the highs during this advance, the fixed condensers were arranged in improper sequence at the selector taps, or one of them has an open connection. A shorted condenser will result in excessive volume when placed in the by-pass; it should be checked for external shorting and discarded if it still by-passes the entire load.

Operation of the Equalizer

Individual amplifiers vary greatly in the amount of distortion present in each tone range. Likewise, in a given amplifier, these characteristics vary with change in volume level. Hence, experimentation in using the equalizer with your own amplifier is the quickest way to attain satisfactory control of results. The equalizer permits a wide range of possible control, to which is added the scope of tone controls already present on your amplifier.

Fig. 1 illustrates a general rule that highs and lows should balance one another, whether closely confined about the middle frequencies for high volume or expanded in wide range for lower volumes. Low volume requires a greater amount of highs and lows in proportion to mid-frequencies, and high volumes are most effective if highs and lows are reduced to a narrow range setting, not only to minimize overload distortions within the amplifier in these ranges, but to reduce room-echo and resonance, which are very unpleasant in higher frequencies at loud volumes.

These principles may be tested easily. For a given recording, set the by-pass to a point where brilliance and scratch noises are not too prominent, then adjust the low-frequency level with the bass cutoff. If the recording is deficient in highs, its balance improves by moving the cutoff up into the lower mid-frequencies. If it is weak in lows, add power in this range by reducing by-pass values, and by opening the bass cutoff to maximum bass, increasing amplifier volume and then applying enough bass cutoff to prevent distortion.

Record scratch for most low-pressure pickups sounds sharpest at the 100 μ fd. by-pass value. Greater val-

PRACTICAL BOOKS for RADIO-ELECTRONICS

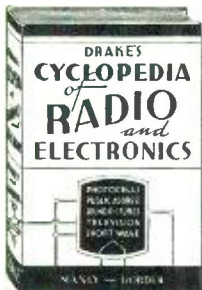

Gateway books help you every day of the year. You don't have to study them . . . Just refer to the information you want when you want it. It's in these books, authoritative, concise . . . waiting to help you make your work easier.

YOU TAKE NO CHANCES

Gateway books are sold only on a 5 day MONEY BACK GUARANTEE. You take no chances . . . your satisfaction is guaranteed.

- CYCLOPEDIA OF RADIO AND ELECTRONICS**
A complete non-technical reference book of 1,000 pages, 1,700 headings, 1,178 illustrations, 130 tables, and 105 graphs cover over 500 definite articles . . . \$5.00
- ELECTRICAL AND RADIO DICTIONARY**
Over 3,800 definitions of technical words and terms used in all branches of radio and electricity. 300 pages, 550 illustrations . . . \$2.50
- PRACTICAL ELECTRICITY, HOUSE WIRING**
Excellent for home repair work. 200 pages, 227 illustrations . . . \$1.50
- SLIDE RULE AND LOGARITHMIC TABLES**
Uses and principles of slide rule and logarithmic tables fully covered. Includes even 10 place log tables. 200 pages . . . \$1.50
- MATHEMATICS FOR READY REFERENCE**
224 pages covering all phases of mathematics to help reader solve almost any problem. \$2.00

USE THIS COUPON

GATEWAY PUBLISHING COMPANY
53 W. Jackson, Dept. RN-2, Chicago 4, Ill.

OK. Send me the books I've checked C.O.D. Remittance enclosed. If C.O.D., I'll pay postman cost of books plus few cents postage. MONEY BACK GUARANTEE still holds.

1 2 3 4 5

Please send your FREE CATALOG

Name

Address

City..... State.....

ues submerge it in increasing predominance of the medium frequencies and lesser ones cut out the hiss *as well as* portions of the high range. Note that use of the bass cutoff to balance whatever proportion of highs is chosen reduces hiss to a minor element in a correctly balanced tone picture, which may be expanded or contracted to include any desired amount of the sound spectrum.

The series load may at times be somewhat reduced to shift emphasis of tone slightly downward for by-pass values up to 100 μfd . Recordings are seldom deficient in the lower mid-range frequencies, but overbrilliant highs resulting from certain types of recordings made in nonresonant studios often benefit if played with emphasis shifted away from them in this manner. With the by-pass set at 250 or 500 μfd ., more of the highs travel via the condenser, hence the reduction of series loading has less effect on higher by-pass values.

Warped or uneven records sometimes produce rumble in the low frequencies, which may be reduced with the bass cutoff; records pressed from worn or duplicate master molds may have very rough and constricted grooves. Resultant noise may be lessened by cutting out the by-pass entirely and also most of the bass range. This method of reproduction from a narrow middle band reduces the unpleasantness of the chatter and gritty sounds of such discs, but there is no effective remedy for a gravelly record of this type.

About Pickups

Manufacturers of crystal pickups supply equalization data which show values of parallel and series resistance loads and of high-frequency by-pass condensers, as well as the frequency-response curves accompanying these circuit values for a particular pickup. The writer is much indebted to the information thus available, for the equalizer circuit in the form described here is the result of experiments based on data supplied with pickups of a number of manufacturers.

Each model has circuit values which give equally distributed response throughout the sound spectrum range, in the straight line which characterizes high-fidelity response. The equalizer is designed to include these values, as given for widely-used types of pickups, and the additional values needed to compensate for the acoustical needs of high and low volume levels shown in Fig. 1.

Wide-Range, High-Fidelity Operation

A sound-system which reproduces all frequencies with equal intensity from 30 to 7,000 cycles per second in wave-forms closely resembling the original input signals is said to be a wide-range, high-fidelity system. In reproducing disc recordings of music, such a system will include turntable rumble and surface irregularities as low-frequency noise, and its high-frequency range will include needle-hiss and mechanical resonances of the pickup. At low volumes, these noises may not be objectionable, but they will become noticeable at average volumes, and at very high volumes their effects will be very unpleasant, unless their ranges are reduced by further adjustment of the equalizer circuit, which was already a part of the system to secure linear, or high-fidelity, response from the pickup.

Thus, the main advantage of a high-fidelity system lies in its medium-volume operation where all of a recording is adequately and clearly reproduced at a level least fatiguing to listeners, and their neighbors. This adequate volume is lower for a high-fidelity system than for a reproduction unit whose restricted range and "mellowness" (overemphasis on low frequencies) cannot present clearly detailed highs without distorted booming in the low range, a range already clipped of its true bass frequencies to avoid the audio power requirements of these frequencies for even moderate volume levels.

"Phonographs" and combinations of this sort are what lead devotees of recorded music to the purchase of higher-powered separate amplifier systems, to escape inadequate, inefficiently-used conventional audio systems. To the subsequent unhappy discovery that higher-powered phonograph systems need a very efficient and flexible control unit, the equalizer circuit, together with description of its theory and operation, is offered as a solution by the author with assurance that the unit meets that need as it was encountered in a number of practical installation problems.

-50-

for
14TH INNING
dependability



Twenty years of
KNOW HOW helps to
give each MICAMOLD
component that extra-
inning stamina that
means so much now!

- CERAMIC
- MOLDED MICA
- POTTED MICA
- MOLDED PAPER
- OIL-FILLED
- DRY ELECTROLYTIC

CAPACITORS

MICAMOLD
Radio Corporation

115 Knickerbocker Ave., Brooklyn 6, N. Y.

NEWCOMB

Portable SOUND SYSTEM



READY for immediate action anywhere... only 39½ pounds... a complete, powerful sound system. Remarkable volume! Users report: practical on land up to ½ mile; at sea, up to 2 miles. Ideal for use in amphibious operations, ship-to-ship communications where radio might be dangerous, life saving operations, civilian or prisoner control, cadet training, field instruction, any similar activity. Unit includes: microphone, amplifier, power supply, loudspeaker. Write today for complete specifications.

NEWCOMB
AUDIO PRODUCTS CO.
COMPLETE SOUND SYSTEMS -
Dept. M, 2815 S. Hill St., Los Angeles 7, Calif.

CODE SENDING RECEIVING SPEED
Free Book

Get High Speed Without Nervous Tension

Amazing Book Shows How "Crack" operators rely on something besides practice to develop their high speeds and proficiency; it explains the "knack" of sound-send and sound-consciousness—the secret of speedy sending and receiving. Once you acquire these mental processes, reading code becomes almost second nature to you: just as the swing rhythm of a dance band becomes automatic to musician and dancer.

Champions Endorse the Candler System

Used in training Commercial Operators, Amateurs, and Radiotelegraph Specialists in Signal Corps, Navy, Marine Corps, Coast Guard, Naval Reserve, Airlines. Wherever the fastest and most efficient operators are found, there you will find Candler trained men.

If you want s-p-e-e-d, if you have any difficulties in operating technique, if 40-50 and more w.p.m. seem fantastic speeds to you—send for this revealing book now. It's yours without cost or obligation. Simply send your name and address.

CANDLER SYSTEM CO.

P. O. Box 928 Denver 1, Colorado, U.S.A. Dept. 2-B
and at 121, Kingsway, London, W.C. 2, Eng.

Specify SAUERISEN

ACIDPROOF CEMENTS—COMPOUNDS FOR

Tanks, Sewers, Stacks, Floors
Technical cements for all purposes.

Send sketches or samples
Sauerisen Cements Company · Pittsburgh 15, Penna.

Transit Utilities

(Continued from page 45)

radio (both present and expected in the immediate postwar period) make a general reallocation inevitable.

In transit, for instance, 20 companies already have gone on record as desiring to install new stations as soon as the necessary equipment is made available. Many others can be expected to follow suit. The investment is not great. In the case of Capital Transit it amounts to only \$20,000—for a company whose worth is around \$40,000,000. But the 10 frequencies presently available for such use do present a potential obstacle. Capital Transit on 31,460 kilocycles gets interference at times from the Brooklyn & Queens Transit Corporation, the first transit utility to use two-way radio. And because the frequencies are limited, the FCC requires that they be used only in emergencies.

At the allocations hearings the transit companies proposed that 20 channels in the 30-40 megacycle band be set aside for their use for emergencies. There is no doubt that the 10 frequencies now allocated them will be inadequate if a large number of the hundreds of companies in the country want to adopt radio. The argument advanced in favor of 20 channels, however, seems open to question. Of the 250 separate transit companies in New York City, it is pointed out, 20 are large enough to be considered likely applicants for radio frequencies. The problem of interference could be solved only by 20 different frequencies. Admittedly sharing of a frequency by two different companies may mean that one is deprived of radio service if the other is handling a serious emergency. There is the interesting possibility, however, that in New York, or any large city having several transit companies, an organization might be formed which would be assigned several frequencies and which would contract to handle emergency communications, and, conceivably, the emergencies themselves, under contract for all the transit companies in a municipality. (Similarly Aeronautical Radio Inc. handles radio communications for many of our commercial airlines.) While the 10 emergency frequencies probably will be increased, the 20 channels (10 extra) requested for this purpose may not be granted.

Unquestionably, radio has proved successful in avoiding and correcting transit emergencies. It is helpful in an almost infinite number of possible situations. Perhaps a fire is reported over the police radio. At the transit company's dispatchers' office the location of the fire is noted and checked against the trolley routes. If the fire is in the vicinity of the tracks, a mobile unit is ordered to the scene. Quite often on arrival the supervisor will find that it has been necessary to place a fire hose directly across the trolley tracks. Where the cars are powered

through an overhead wire, it is a matter of seconds to restore service. Grooved metal hose jumpers protect the fire hose and the streetcar rolls right over them. If the power is derived from a contact rail on the ground, the problem is more complex. The supervisor radios his dispatcher that a hose bridge will be needed. This cumbersome device holds the hose aloft so that trolley traffic may proceed normally underneath it. The dispatcher, of course, reroutes traffic until the bridge is delivered and set up, and normal service can be resumed.

With two-way radio equipment all these arrangements can be completed in an amazingly short time. But for most transit companies all the work must be directed by telephone. The delay may amount to two hours. Supervisors who cruise their districts report to the dispatcher every 30 minutes as a matter of routine. Capital Transit, for years has had 20 telephones at strategic points throughout Washington. If the fire did not happen to be located near a phone, the supervisor might be delayed getting to one. Perhaps the emergency truck and crew usually stationed at the main office have just been sent out on a call.

In extreme emergencies, such as floods or severe storms, telephone lines may be crowded or even cut off completely. Availability of radio in such cases may mean lives saved. In cities which are subject to flood conditions, transit company supervisors are stationed at the low points on the system during flood danger to report on the rise or fall of the water. When conditions change rapidly and instant communication is not possible, cars or buses may be trapped by the rising water.

Another case in which instant supervision is needed is damage to the wire structure with resultant danger to persons or autos from the 600-volt trolley wire.

A report of an incident in Cleveland is typical. "On March 19, 1944, at 7.45 a.m., an automobile hit and broke a steel pole which helped support trolley wire at East 75th St. and Quincy Ave. The pole fell, blocking the track and causing trolley wire to sag badly. Zone 3 supervisor was notified by radio and cleared the tracks and held the wire up to let the cars move until the line truck arrived. Total delay was only eight minutes."

One potentially useful bit of equipment which requires no additional frequencies is the walkie-talkie unit. With it, emergency crews in a situation covering an area of several blocks could stay in constant contact with each other and with the supervisor. A fairly common difficulty in which they certainly would be used is when a whole section of track becomes temporarily useless due to power failure. Two crews working from either end of the track and testing as they go along can clear up the trouble much faster if one immediately can notify

the other to come and help make repairs as soon as the source of the trouble is discovered.

A recent traffic control device, a "headway recorder," is particularly effective when combined with use of two-way radio. Electrical contacts at selected check points are activated by the passage of the trolley. The current is carried on a telephone wire to the recorder where a pen automatically uses a mark each time the contact is closed. A moving tape less than ten inches wide may contain twenty columns for as many different check points. Capital Transit's headway recorder, installed in July, has two tapes with 20 columns on each. On some routes the lines come close together—perhaps there is only a minute-and-a-half headway between cars—on others the spacing of the lines indicates a regular 15-minute headway. If the dispatcher notes a four-minute headway when it should be only two, he radios one of the mobile units to make an investigation. The reports he may get back range from "overloading" (with longer delays at stops and more frequent discharge stops) or "funeral" to "collision" or "defective car." Companies using headway recorders find that the dispatcher almost invariably is able to spot trouble on a line before it is reported.

An incident at the Brooklyn & Queens Transit corporation shows how well this can work with the two-way radio. The dispatcher on duty at the machine called to the radio dispatcher that one location had a break of six minutes on a line with a three-minute headway. An inspector sent to check up found a truck overturned on the track. He radioed for an emergency wagon, but cancelled the call a minute later. He had gotten a passing truck to pull the overturned vehicle off the track. The line was blocked only eight minutes from the time the delay was spotted at the dispatchers' office.

While these machines work only on cars using tracks, experiments point to the possibility of radio-activated headway recorders for buses. Such use of radio, however, does not come under the "emergency" use for which frequencies are now granted to transit companies. They are requesting, however, 20 additional channels for this and related traffic control and supervisory use. Another experiment whose future will depend on the outcome of the FCC allocation hearings is a radio-controlled track switch device. It is said to be simpler and more foolproof than the present electrically-operated control; it involves an electronic-tube circuit controlled by a switch on the instrument panel, entirely independent of the main power circuit. The twelve extra channels requested for this use probably will not be granted.

Greater use of radio certainly will mean better service to the public, and better service will mean better business for the transit companies. During 1943 they provided passengers in

RADIO SPEAKERS
for all applications

Recently expanded production facilities combined with complete engineering "know-how" enable Consolidated Radio Products Co. to supply the finest radio speakers available. Speakers can be furnished in the following ranges:

Dynamic Speakers from 2 inches to 18 inches
Permanent Magnet Speakers from 2 inches to 18 inches
Headsets

Electronic and Magnetic Devices
CONSOLIDATED RADIO
Products Company
350 W. ERIE ST., CHICAGO 10, ILL.

Small and Medium
TRANSFORMERS

Consolidated Radio is also a nationally known manufacturer of small and medium transformers including Pulse Transformers, Solenoid and Search Coils.

Engineering service is available to design transformers and speakers for special applications, or to your specifications.

Available **NOW**
THE Jensen SALESKIT
 for **RADIO SERVICEMEN**



7 This colorful, compact, convenient Saleskit fills a long-felt need for a handy demonstrating kit that can be slipped into the pocket and taken on service calls. Contains three Jensen Concert Needles retailing at \$1.00 each and three Jensen Genuine Sapphire Needles retailing at \$2.50 ea. The serviceman sells the six needles for \$10.50 but pays only \$5.25. A new saleskit is supplied with each 6 needles.

JENSEN INDUSTRIES, INC.
 737 NORTH MICHIGAN AVE.

CHICAGO 11 ILLINOIS

Now for **EVERY WORK SHOP!**
NEW Invention Electroplates by BRUSH



Easy to Plate **CHROMIUM GOLD, SILVER, NICKEL, COPPER**

For Pleasure and Profit!

If you have a workshop—at home or in business—you need this new Warner Electroplater. At the stroke of an electrified brush, you can electroplate models and projects—you can replating worn articles, faucets, tools, fixtures, silverware, etc with a durable, sparkling coat of metal. . . . Gold, Silver, Chromium, Nickel, Copper or Cadmium. Method is easy, simple, quick. Everything furnished—equipment complete, ready for use. *By doing a bit of work for others, your machine can pay for itself within a week.* So make your shop complete by getting a Warner Electroplater right away. Send today for **FREE SAMPLE** and illustrated literature. **ACT AT ONCE!**

WARNER ELECTRIC CO., DEPT. A-34
 360 North Michigan, Chicago 1, Illinois

FREE Details & Sample!

WARNER ELECTRIC CO., 360 N. Michigan, Chicago 1, Dept. A-34
 Gentlemen: Send Free Sample and Details to:

Name _____
 Address _____
 City _____ State _____

COMMERCIAL RADIO INSTITUTE

A radio Training center for over twenty-four years.

RESIDENT COURSES ONLY.

ACCREDITED FOR VETERAN TRAINING

Pre-induction, Broadcast, Marine, Telegraphy, Aeronautical, Television, Service. Classes now forming for Mid-year term, Feb. 5th. Literature upon request.

Dept. D., 38 W. Biddle St. Baltimore 1, Md.

the U.S. with 22 billion rides—a war-born increase they would like to maintain. Capital Transit's engineers have worked out half a dozen different methods of improving service which depend on increased use of their frequency. At present they send and receive about a hundred radio messages a day. The messages average half a minute each. Thus, the frequency is used less than an hour a day. Perhaps another hundred incidents a day are handled by telephone as they are not considered "emergencies" in the sense intended by the FCC. But, by such limitation of use, the FCC is enabled to assign the same frequency, despite limited interference, to several other companies and still leave a margin of safety sufficient to handle really serious and widespread emergencies in any area.

The additional channels requested by the transit utilities now are being used by other services for which other frequencies must be allocated if the transit companies are to be given all or part of what they ask. Some rearrangement probably will be made; perhaps even the definition of emergency may be broadened. But it seems certain that at the present time each company's use of its frequency will be limited.

-30-

STANDARDIZED GRAPHICAL SYMBOLS

The American Standards Association has recently published a bulletin, No. Z32.5-1944, entitled "Graphical Symbols for Television, Telegraph, and Radio Use." This bulletin presents the graphical symbols and abbreviations for use in schematic diagrams, that are considered to be standards.

In conforming with the policy of RADIO NEWS, we will adopt these standards as soon as possible, as they are presented.

Fig. 1. shows the old and new methods of symbolizing fixed and trimmer condensers. In regards to the fixed condenser, a curved line will be used. This curved element, where it is necessary to identify the capacitor electrode, shall represent the outside electrode in fixed paper dielectric and ceramic dielectric capacitors. It also shall indicate the negative electrode in electrolytic capacitors.

Variable trimmer capacitors will be indicated, as shown in Fig. 1, with the letter "T" directly alongside. Where

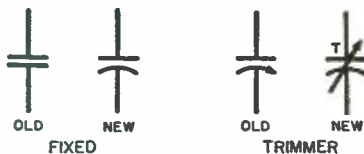

Fig. 1.

variable capacitors are to be indicated, the same symbol will be used with the letter "T" omitted. The curved line will indicate the moving element in variable capacitors.

All other symbols, which have been adopted as standards, conform in general with those appearing in the past in this publication. . . . Editor.

Classified

Rate 20c per word, Minimum, 10 words

CORRESPONDENCE COURSES

PREPARE now for tremendous opportunities in new fields of Radio after the war. Training for Federal licenses. Write for particulars. American Radio Institute, 44 East 23rd St., New York 10, N. Y.

USED Correspondence Courses and Educational Books sold or rented. Inexpensive. Money-back guarantee. Write for Free Catalog listing 4000 bargains.—(Courses Bought.)—Lee Mountain, Pisgah, Ala.

CORRESPONDENCE Courses and self-instruction books, slightly used. Sold. Rented. Exchanged. All subjects. Satisfaction guaranteed. Cash paid for used courses. Complete information and 92-page illustrated bargain catalog FREE. Write Nelson Company, Dept. 2-59, Chicago 4.

USED Correspondence Courses and Technical Books Bought, Sold, Rented. Satisfaction Guaranteed. Free Catalog. Educational Exchange, B2, Henagar, Ala.

RADIO ENGINEERING

RADIO Engineering, Broadcasting, Aviation and Police Radio, Servicing, Marine Operating and Electronics taught thoroughly. Expenses low. Write for catalog. Valparaiso Technical Institute, Dept. N, Valparaiso, Ind.

PATENT ATTORNEYS

INVENTORS—Before disclosing your invention to anyone, send for Form "Evidence of Conception"; "Schedule of Government and Attorneys' Fees" and instructions. Sent free. Lancaster. Allwine & Rommel, 414 Bowen Building, Washington 5, D. C.

PATENTS SECURED. Two valuable booklets sent free. Write immediately. Victor J. Evans & Co., 948-A Merlin Bldg., Washington 6, D. C.

RADIO EQUIPMENT

RADIO Service men and experimenters send for our giant radio catalogue. Save dollars. United Radio Co., (1000M) Newark, N. J.

FOR SALE

SELENIUM Rectifiers—half wave, 4½ Amperes, 10 volts, \$4.50, Full Wave, ½ Ampere, 10 volts, \$1.85, 30 Volts, 1 Ampere, \$3.49, Schematic of A.B. Eliminator using ½ Ampere Rectifier, 25c. Free with order, list free. Milton Bursma, 105 Avondale, Jackson, Mich.

BUZZER Code Practice set complete with key, battery and instructions. Sends real wireless signals. Only \$1.65. Two sets \$3.00. Guaranteed. Rathert Electric, Dept. N, Cresco, Iowa.

LOWEST Prices. Radio Tubes, parts. Bargain lists 3c. Potter, 1314 McGee, Kansas City 6, Mo.

WANTED

SONG Poems wanted to be set to music. Send poem for immediate consideration. Five Star Music Masters, 420 Beacon Bldg., Boston 8, Mass.

WANTED: Used test equipment, not necessarily working. Robert Smythe, 634 E. Colonial Dr., Orlando, Fla.

MISCELLANEOUS

METERS, Instruments, Vacuum-tube Voltmeters repairs and Recalibrated. Immediate service and guaranteed workmanship. The Moring Co., 1414 Main St., Lynnefield Centre, Mass.

MAGAZINE (back dated)—foreign, domestic, arts. Books, booklets, subscriptions, pin-ups, etc. Catalog 10c (refunded). Cicerone's, 863 First Ave., New York 17, N. Y.

HELP WANTED

HELP Wanted: One good repairman with 10 years experience, permanent job, highest pay. Man with equipment and car preferred. Write Munroe Radio Service, 111 Shelby St., Kingsport, Tenn.

Guaranteed Rebuilt

VIBRATORS—\$1.00 ea.

Send old vibrator. For very prompt delivery, enclose remittance and return postage. We rebuild any make or kind of vibrator or relay. Send your old vibrator to

BEST VIBRATOR CO., Box 5802
 Cleveland 1, Ohio

New Service: No Cost

**... Complete Data on
Materials & Sources**

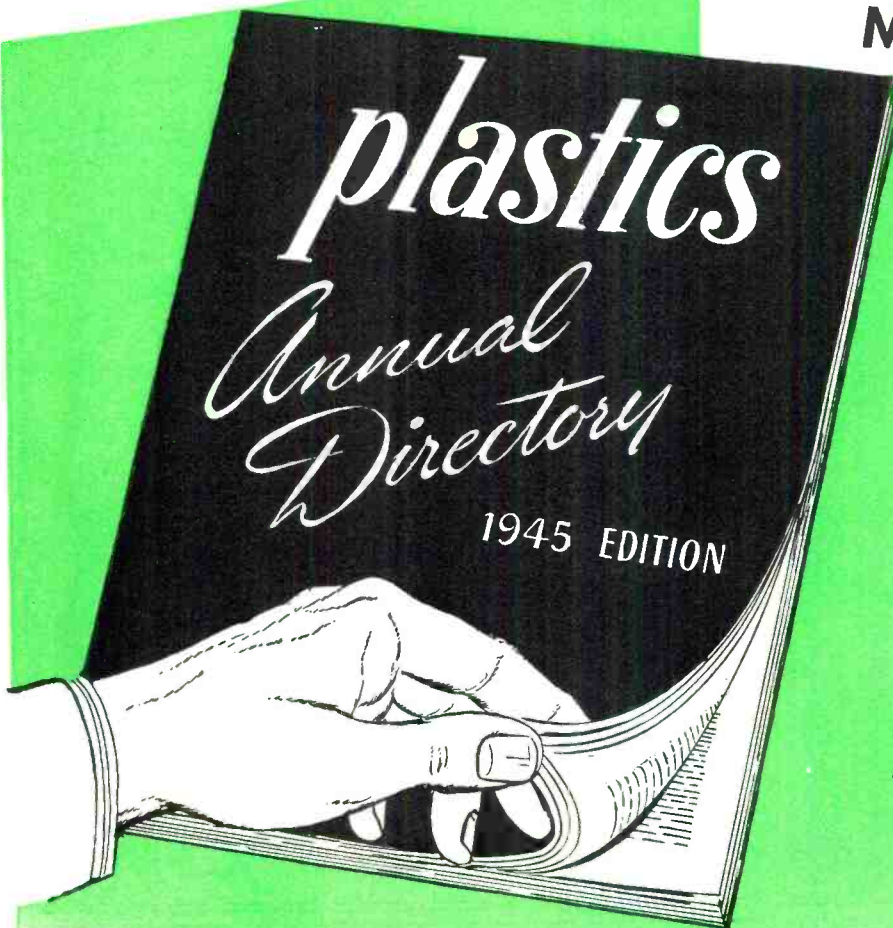

**Published in March
12 Months Active Life**

A Basic Source Book On:

- Raw Materials
- Machinery and
Tool Manufacturers
- Plastic Products

**The Entire Plastics Field
Within Two Covers**

The March, 1945, issue of PLASTICS is the Annual Plastics Directory, the most complete book of its kind in the field... a "special issue" in the most constructive sense... an extra value to advertisers at no added cost.

Mailed to the regular subscribers of PLASTICS, this valuable reference will reach:

- *3100 key personnel within the plastics industry,
- *10,015 top executives of the 40 industries who are actual or potential users of plastics,
- *1052 engineers, chemists, designers, architects, inventors, etc., the men who directly influence specifications and purchases.

These are the men who will constantly refer to the PLASTICS Directory during its 12 months active life—who will keep it permanently on reference shelves for its information that goes beyond the listing of useful data!

For, in addition to its useful tables and data on plastics, PLASTICS Annual Directory will carry a symposium by the engineers of a dozen industries on the past, present and future uses for plastics in their fields. Additional articles will present export conditions, such as possible foreign competition, availability of manpower and materials in these fields, with special emphasis on Latin American markets.

TO THE ADVERTISERS, PLASTICS ANNUAL DIRECTORY represents an outstanding opportunity to have their messages read, re-read, and preserved for future reference! It's a "solid" special issue—a special chance—at no extra cost!

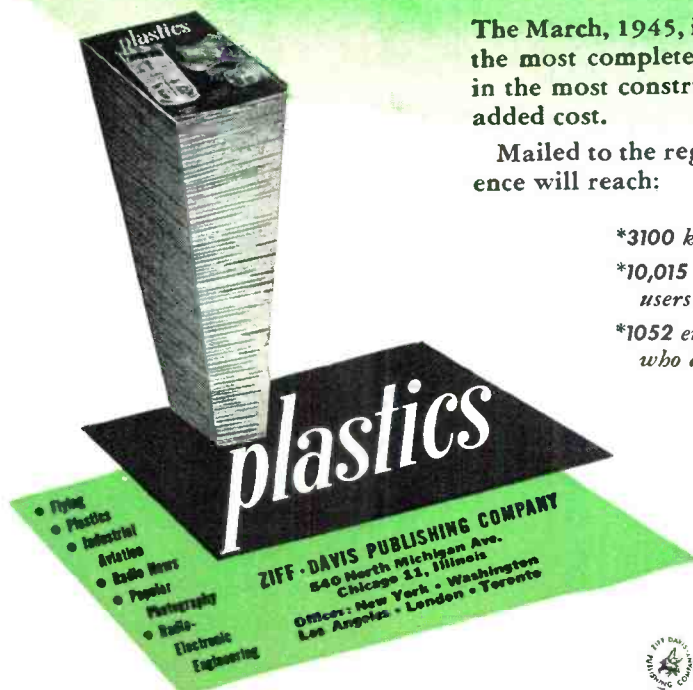

February, 1945

147

Wanted ENGINEERS

- Radio
- * Electrical
- Electronic
- * Mechanical
- Metallurgical
- * Factory Planning
- Materials Handling
- Manufacturing Planning

Work in connection with the manufacture of a wide variety of new and advanced types of communications equipment and special electronic products.

Apply (or write), giving full qualifications, to:

R.L.D., EMPLOYMENT DEPT.

Western Electric Co.

100 CENTRAL AV., KEARNY, N. J.

*Also: C.A.L.

Locust St., Haverhill, Mass.

Applicants must comply with WMC regulations

SERVICEMEN!

Can you write articles on construction, substitutions, repairing short-cuts, or other subjects of particular interest to radio servicemen for publication in a radio magazine? If you can, write and give us a list of the subjects on which you can prepare a 2000 or 3000 word article.

Reply, Box 370, RADIO NEWS
540 N. Michigan Ave., Chicago 11, Illinois

★ INDUSTRIAL ★ MAN-POWER BUREAU

Opportunities IN PRESENT AND POSTWAR WORK

Senior and Junior graduate engineers with one or more years radio experience wanted by an expanding manufacturing division of an established communication company.

Present activities include high and medium power transmitters, frequency shifters, other communication products for the Navy and designs and models for postwar use.

Engineers with practical experience also required for radio communication plant installation and test in foreign countries.

Phone, call or write stating experience, education, present salary, etc., to

PRESS WIRELESS, INC.

HICKSVILLE, L. I.

ATT.: S. A. BARONE

CHIEF MFG. ENGR.

HELP WANTED TRANSFORMER & SMALL ELECTRIC MOTOR MEN

ENGINEERS DESIGNERS DRAFTSMEN TECHNICIANS

For war time and post-war design and development of intricate, specialized, hermetically sealed transformers, and special purpose fractional h.p. motors.

Write, giving details about age, experience, past salaries to

SPERRY

GYROSCOPE COMPANY, INC.
RESEARCH LABORATORIES
STEWART AVE. AND CLINTON RD.
GARDEN CITY, NEW YORK

RADIO PARTS SALESMEN WANTED

Countermen! Parts Jobber
Salesmen! Your Chance to
Join Leading National Manu-
facturer

There's a good starting salary and unusual opportunity for quick advancement to the radio parts jobber salesmen or countermen who get these jobs. We're leaders in the field nationally, not a war baby and we're getting tuned up to do a hard hitting sales job. Our headquarters is in the New York metropolitan area.

To qualify you must know parts, have good sales or technical background and be anxious to better yourself.

Tell us about your education, experience, other qualifications and salary expected. Write in full confidence.

WRITE NOW TO BOX 383

c/o RADIO NEWS
540 N. Michigan Ave., Chicago 11, Ill.

"This section is designed to help the radio industry obtain trained, experienced, technical men to facilitate vital war production. Before applying for any of these positions consult your local United States Employment Service office to determine War Manpower Commission regulations concerning the changing of jobs. If you are already employed in war work at your highest skill, stick to your present job."

IS *Your* OPPORTUNITY HERE?

Think this over carefully. Where do you go from the spot you're in now? Are your surroundings friendly and full of promise for the future? Consider now the place you might fill in the electronic industry leadership assured to the fine staff of engineers, scientists, technicians at NATIONAL UNION RADIO CORPORATION. We're all young in years and ideas though most of us are old in electronic experience. We enjoy working together. We know we're going places! We're inviting you to join us if you have the qualifications. If you're looking for a success pattern for your future, it may be here with us at National Union. Find out! Come in and talk it over or write us!

NATIONAL UNION WANTS:

- * **QUALITY CONTROL ENGINEER AND SENIOR TUBE ENGINEERS**—These men MUST have executive ability and extensive experience with radio tube manufacture. The pay and opportunities are commensurate with your ability.
- * **COMMERCIAL ENGINEERS**—Men with pleasing personalities, initiative and a knowledge of vacuum tube applications.
- * **TEST EQUIPMENT ENGINEERS**—Men with special interest in circuit design and applications.
- * **QUALITY CONTROL MEN**—Statistical Training is chief requirement though a knowledge of vacuum tubes will help.
- * **JUNIOR ENGINEERS—MEN or WOMEN**—If you have a college degree in Physics, Electrical Engineering, Mathematics or Chemistry and are the type of young person who is able to 'go places,' you'll be starting with your best foot forward if you are accepted at National Union Radio Corporation.
- * **FOREMEN and ASSISTANT FOREMEN**—Men with foremanship experience in exhaust, stem or grid operations in radio tube manufacture.
- * **TECHNICIANS, CIRCUIT MEN**—Maybe you've been repairing radios, maybe you've gained a knowledge of circuits by working on test equipment. It makes no difference either way if you have the 'know how' of circuits write us about the opportunities we have to offer!

WOMEN!

We have a number of fine young women engineers with us now. We need more. If you have a degree in Electrical Engineering, Physics, Chemistry or Mathematics and are seeking career opportunities, investigate.

Phone or Write

DR. L. GRANT HECTOR

Director of Engineering

NATIONAL UNION RADIO CORPORATION

RESEARCH LABORATORIES

Plane St. at Raymond Blvd.

Newark 2, New Jersey

WMC RULES OBSERVED

Save WASTE PAPER

It is a vitally needed
war weapon

Buy your share of War Bonds

POSITIONS IN CHINA

In the operation of an important air line under extremely difficult conditions we need experienced aircraft radio service men to maintain our large fleet of aircraft and extensive ground installations. Single men preferred. Air transport in the Far East has a big future.

CHINA NATIONAL AVIATION CORPORATION

135 East 42nd Street, New York City 17, N. Y.

A WAR JOB FOR YOU

Men and Women Wanted

for

RADIO WORK

at

WESTINGHOUSE

Radio Amateurs, Radio Service Men,
Ex-Service Men with Radio Training,
Girl and Women Graduates of
Radio Training Courses

are

needed to test

Radio and Electrical Equipment

All grades of positions open to fit
individual electrical background.

Apply by letter or in person

to

Westinghouse Electric and Mfg. Co.
2519 Wilkens Ave.—Baltimore 3, Md.

or

Susquehanna and Front Streets
Sunbury, Pennsylvania

Those now employed at highest skill
in essential industry need not apply

FIELD SERVICE ENGINEERS

FOR DOMESTIC AND
FOREIGN SERVICE
MUST POSSESS GOOD
KNOWLEDGE OF RADIO

Essential workers need release

HAZELTINE CORPORATION

58-25 Little Neck Parkway
Little Neck, Long Island, N. Y.

ELECTRICAL OR RADIO ENGINEER WANTED

Should have general experience in Electrical or Radio Measurements. Graduate engineer (radio or electrical) from recognized engineering school desirable. Long-established radio-electrical components manufacturer in New England, doing war work at present. Postwar future for right man. Give detailed outline of experience, etc., salary requirements.

BOX 384, c/o RADIO NEWS

**INDUSTRIAL
MAN-POWER BUREAU**

Continued

Transmitting or Receiving

**RADIO STATION
TECHNICIANS**

MEN AND WOMEN

for Point-to-Point International
Radio-communications Stations
in the United States.

Applicants must possess at least
Second Class commercial Radio-
telegraph Operator's License.

Essential workers need release
statement.

Apply weekdays except Satur-
days between 10 am and 3 pm
or write

PERSONNEL DEPARTMENT
R.C.A. COMMUNICATIONS, Inc.

64 Broad Street
NEW YORK 4, N. Y.

**HELP WANTED
ENGINEER**

CAPACITOR LABORATORY
ELECTROLYTIC OR
PAPER DESIGN

DRAFTSMEN

DETAIL ON
AUTOMATIC MACHINERY
WMC RULES

**MICAMOLD RADIO
CORPORATION**

1087 FLUSHING AVE.
BROOKLYN, N. Y.

Technial

Writers Wanted!

Engineers and physicists who have
had experience in (spare time) writ-
ing technical manuscripts on elec-
tronic design or applications in-
cluding radio, television, facsimile,
etc. Highest rates.

Reply Box 310, c/o RADIO NEWS
540 N. Michigan Ave., Chicago 11, Ill.

U.H.F. Course
(Continued from page 59)

however, the magnetic field will col-
lapse and force the electrons to flow
around the circuit into the other plate
of the condenser. The condenser now
is charged up, but in the other direc-
tion. The process is ready now for
repetition. While in the above exam-
ple the energy was introduced into the
circuit via the condenser, another coil
inductively coupled to the first one
would have been quite as satisfactory.
The same is true of the cavity resona-
tor, with the electron beam doing the
activating. This latter means might
be called capacity coupling although it
might be rather hard to say this with-
out some reservations.

The second matter to consider per-
tains to the points where a possible
loss of energy could take place. If the
cavity resonator were enclosed entire-
ly and the dielectric was air (as it
nearly always is) then the only possi-
ble place that energy could be lost
would be in the confining walls. In
the preceding explanations, the walls
always have been postulated to be con-
structed of materials that had no re-
sistance or, what is the same thing, in-
finite conductivity. This was done to
simplify the discussions so that more
important ideas could be understood.
Now, however, it is time to remember
that actually there are no materials
that possess the above properties and
anything that could be used for the
walls of the cavity resonator would
have some resistance, no matter how
slight. The waves in a resonator, in
their continual back and forth motion,
strike the various walls and cause cur-
rents to flow. Current flowing through
a resistance will lose energy in a man-
ner dependent on the amount of flow
and the resistance. I²R covers this
completely. This, then, would be taken
from the energy contained in the fields
in the resonator and would represent a
loss. The latter would represent to a
cavity resonator what the resistance
in the coil and connecting wires would
mean to a low-frequency resonant cir-
cuit.

While the walls are perhaps the
place where the greatest amount of
energy is lost, it is by no means the
only place. Cavity resonators never
are enclosed completely and so some
energy could escape through these
openings. By proper design, this lat-
ter loss is generally kept very small.
A third method whereby energy would
be lost could be brought about by elec-
trons arriving at the resonator grids
in time to absorb energy instead of
giving some. This latter point can be
very important, especially with poor
design, for the entire oscillating pro-
cess depends on the fact that the grids
obtain more energy from the electrons
than they give up. This third type of
loss is taken care of by combining it
with the total received energy and
using their difference.

ENGINEERS

**Are You Concerned With
YOUR POST WAR FUTURE?**

The Federal Telephone & Radio Corporation, the
manufacturing unit of the International Tele-
phone & Telegraph Corporation with its multi-
ple business activities extending to all parts of
the civilized world, will accept applications from
experienced men for immediate employment
with almost limitless post war possibilities.
These positions should interest those with an
eye to the future and whose interest lies in
forging ahead with this internationally known
organization whose expansion plans for post
war are of great magnitude covering all types
of radio & telephone communications. Advance-
ment as rapid as ability warrants. Majority of
positions are located in the New York area!
Essential workers need release statement.

We need the following personnel! Men
with long experience or recent grad-
uates considered.

- ENGINEERS
ELECTRONICS
ELECTRICAL
RADIO
MECHANICAL
CHEMICAL
TRANSFORMER DE-
SIGN
- SALES AND APPLI-
CATION ENGINEERS
PHYSICISTS
DESIGNERS
DRAFTSMEN
TOOL DESIGNERS
TECHNICAL WRITERS

Look Ahead With Federal!

If inconvenient to apply in person, write letter in full, detailing
about yourself, education, experience, age, etc., to Personnel Manager.

FEDERAL TELEPHONE & RADIO CORP.

39 Central Avenue

EAST NEWARK

NEW JERSEY

Complete stocks of most radio parts and tubes. Send us list of what you need. Regular net prices apply to all shipments.

WE WANT TO BUY STOCKS OF BOXED RADIO TUBES IN MOST ANY QUANTITIES. QUOTE PRICES, QUANTITIES, TYPES, ETC.

RADIO LABS

"Parts Distributor"

P.O. Box 72
Mobile 1, Alabama

SPEAKERS RECONED!

4"-\$1.00 6"-\$1.20 10"-\$2.00
5"-\$1.10 8"-\$1.65 12"-\$2.25

PROMPT SERVICE
EXPERT WORKMANSHIP

York Radio

DISTRIBUTING COMPANY

130 SO. YORK ST. · ELMHURST, ILLINOIS

LE S Correspondence Courses in
RADIO and ELECTRICAL ENGINEERING

ELECTRICAL ENGINEERING Get good grasp of wide electrical field. Prepare yourself at Low Cost, for secure future. Modern courses. So simplified anyone can understand quickly.

RADIO ENGINEERING Extra fine course in radio, public address, photo-electric work. Trains you to be super-service man, test vacuum-tube technician. Servicemen needed badly. Diploma on completion.

WRITE Send postcard or letter for Free LOW \$25 Either Course
Copies of school catalogs, full details, all about deferred payment plan, etc. **SEND NOW!**

LINCOLN ENGINEERING SCHOOL, Box 931R-74, Lincoln 2, Nebr.

PEN-OSCIL-LITE

Extremely convenient test oscillator for all radio servicing; alignment • Small as a pen • Self powered • Range from 700 cycles audio to over 600 megacycles u.f. • Output from zero to 125 v. • In use by Signal Corps.

GENERAL TEST EQUIPMENT CO.

38 Argyle Buffalo 9, N. Y.

**WAR BONDS
TODAY
PAVE THE WAY
TO
VICTORY**

Returning to the discussion of the Q of a cavity resonator, the preceding paragraphs indicate that the ratio:

Volume of Resonator

Surface Area of Resonator

should be proportional to the Q of the resonator. The ratio is based on the fact that the energy is contained in the volume of the resonator while the loss in energy occurs in the walls and these are expressed by the surface area. With this ratio a higher Q will be obtained if the volume to surface ratio is large and in practice this objective is striven for when these small units are designed.

The reader will notice that fundamentally the definition of Q and all it stands for (selectivity and efficiency of a circuit) still remains the same, although expressed slightly differently. The need for a change was brought on by the variation in design and construction of this newer tuning unit. That it can be altered and still possess the same meaning shows at once the relationship between the old and the new and speaks well for a system of units that is so flexible.

In the operation of cavity resonators with high-frequency oscillators, the resonator structure is generally made an integral part of the tube itself and as such is subject to changes in volume because of the heat that is generated in the tube, both at the collector plate (see article on Klystron) and at the filament. A change in volume automatically will alter the resonant frequency of the resonator. In practice, this undesirable effect is minimized by constructing the resonator with materials that will counteract the change in frequency (a decrease).

With the conclusion of the discussion on the Q of a cavity resonator, this article is brought to a close. Only the basic theory has been covered and applied essentially to a simple rectangular resonator. Needless to state, almost innumerable forms of resonators may be used, all essentially the same except for the field distributions. To date, the mathematical theory has been applied to only a few of these complex shapes.

(To be continued in April issue)

PHOTO CREDITS

Page	Credit
25, 26, 27.....	Consolidated Vultee Aircraft Corp.
28 (top), 29, 30, 31.....	Dean Towner
28 (bottom).....	Kirke E. Davis
32, 33, 34.....	Fairchild Camera & Instrument Corp.
35.....	U. S. Army
36, 98.....	U. S. Signal Corps
37.....	Aeme
38, 39.....	Aerovox
40.....	Thordarson Elec. Mfg. Co.
41.....	U. S. Army Air Forces
44, 45.....	Capital Transit Co.
46.....	National Safety Council
48, 49, 50.....	Grenby Mfg. Co.
53.....	Scott Radio Laboratories, Inc.

Order From RADOLEK

RADIO PARTS ELECTRONIC APPARATUS SOUND SYSTEMS

Make Radolek your dependable buying source for everything in radio, sound and electronics. We can supply essential merchandise to repair any radio—tubes, condensers, resistors, controls, transformers, etc.—all at lowest prices.

Large Stocks: Radolek's large stocks assure the finest and most complete selections of all available items. Thousands of servicemen rely on Radolek for their entire requirements.

Fast Service: Streamlined handling of every order simplifies procurement problems and gives you fastest possible delivery. Whatever your need—for industry, the Armed Forces or Civilian replacement—ordering from Radolek saves time, effort and expense.

Get This Free
Buying Guide



SEND TODAY!

RADOLEK CO., Dept. B-99
601 W. Randolph St., Chicago, Ill.
Please send your FREE Buying Guide.

Name

Address

DEALER SERVICEMAN SOUND ENG.

SAVE AT RADOLEK

Electronics RADIO ENGINEERING

NEW COURSES FOR MODERN NEEDS

RADIONICS, the science of electronic applications, is widening its horizon hour by hour. There's a secure future in this field for YOU—provided you put OUR TRAINING ON YOUR *must* list NOW.

Needed at once are specialists in Marine Radio, Police Radio, Aviation Radio, Broadcasting, Television, Frequency Modulation, High Frequency Broadcasting, and Commercial Radio Telegraph. That need will continue.

Our school is co-educational. It offers to women as well as men streamlined elementary and advanced courses for Radio Servicemen, Radio Engineering Assistants, Radio Test and Maintenance men. The work is thorough, practical, void of frills. The courses are approved by State Vocational Departments, Major Airlines, State Police Systems, Radio manufacturers, and hundreds of Broadcasting Stations.

Credit is given for Army radio courses and experience toward any of our courses. High school graduation or its equivalent necessary for advanced courses. Tuition at pre-war levels. Send for catalog *today*.

MAIL THIS COUPON NOW!

VALPARAISO TECHNICAL INSTITUTE,
Dept. R., VALPARAISO, Ind.

NAME.....

P. O. ADDRESS..... AGE.....

CITY and STATE.....

CATALOG REQUEST—RADIO NEWS

ADVERTISER	AGENCY	PAGE No.	ADVERTISER	AGENCY	PAGE No.
Aerovox Corporation.....	Austin C. Lescarboursa & Staff.	153	Merit Coil & Transformer Corp.....	Ross Llewellyn	78
Alliance Manufacturing Company..	Campbell-Sanford Adv. Co.....	94	Micamold Radio Corporation	Hart Lehman Advertising.....	143
Allied Radio Corp.....	Henry H. Teplitz.....	62	Micamold Radio Corporation.....	Equity Advertising Agency.....	150
American Phenolic Corporation.....	Evans Associates, Inc.....	17	Miles Reproducer Co., Inc.....	Altomari Advertising Agency.....	140
Atlas Sound Corporation.....	Hart Lehman Advertising.....	102	Millen, James Mfg. Co., Inc.....	Jamers Millen, Inc.....	12
Audak Company.....	Hart Lehman Advertising.....	8	Murdock, Wm. J., Co.....	John A. Smith & Staff.....	64
Audel Publishers.....	Grant & Wadsworth, Inc.....	126	McBurney, A. D.....	West-Marquis, Inc.....	116
Bell Telephone Laboratories.....	N. W. Ayer & Son, Inc.....	129	McElroy Manufacturing Corp.....	Shappe-Wilkes, Inc.....	120
Best Vibrator Co.....		146	McGraw-Hill Book Co.....		122
Bliley Electric Company.....	Hardy Advertising.....	21	National Company.....	Graydon Smith.....	65
Brach, L. S., Mfg. Corp.....	United Advertising Agency.....	100	National Electronic Supply.....		82
Breeze Corporations, Inc.....	Burke Dowling Adams.....	121	National Radio Institute.....	Van Sant, Dugdale & Co., Inc....	3
Bruno Tools.....	West-Marquis, Inc.....	112	National Schools.....	Jamers Company, The.....	71
Burgess Battery Company.....	Howard H. Monk & Associates..	88	National Union Radio Corporation ..	Hutchins Adv. Co., Inc.....	105, 149
Burstein-Applebee Co.....	Frank C. Whalen Adv. Co.....	132	Nelson Co.....	A. N. Baker Adv. Agency.....	106
Candler System Co.....	Van De Mark Adv. Inc.....	144	Newcomb Audio Products Co.....	Gail Hall Advertising.....	144
Capitol Radio Engineering Institute..	Henry J. Kaufman Adv.....	68	Ohmite Manufacturing Company.....	Henry H. Teplitz.....	61
Centralab.....	Gustav Marx Adv. Agency.....	154	Olson Radio Warehouse.....	Jessop Advertising Agency.....	130
China National Aviation Corp.....		149	Onan, D. W. & Sons.....		116
Cinaudagraph Speakers, Inc.....	Michael F. Mayger, Adv.....	94	Pernoflux Corporation.....	Turner Advertising Agency.....	84
Clare, C. P. & Co.....	J. R. Hamilton Adv. Agy., Inc.....	141	Press Wireless, Inc.....		148
Commercial Radio Institute.....		146	R.C.A. Communications, Inc.....	Albert Frank-Guenther Law, Inc.....	150
Concord Radio Corporation.....	Shappe-Wilkes, Inc.....	74	RCA Institutes, Inc.....		120
Connecticut Telephone & Elec. Div..	Wilson & Haight, Inc., Adv.....	69	Radio Corporation of America.....	Kenyon & Eckhardt, Inc.....	81, 101
Consolidated Radio Products Co.....	Burton Browne Advertising.....	145	Radio Distributing Co.....		140
Cornell-Dubilier Electric Corp.....	Reiss Advertising.....	111	Radio Labs.....		151
Cornish Wire Company, Inc.....	Hart Lehman Advertising.....	124	Radio Parts Company.....	Sidney S. Lovitt.....	110
Coyne Electrical School.....	McJunkin Advertising Co.....	103, 128	Radio Supply & Eng. Co., Inc.....	Karl G. Behr Adv. Agency.....	120
DeForest's Training, Inc.....	MacDonald-Cook Co.....	15	Radio & Technical Division of:		
Delco Radio Div., General Motors...	Campbell-Ewald Company.....	91	Murray Hill Books, Inc.....	Harry P. Bridge Co., The.....	86, 87
Drake Electric Works, Inc.....	William Hoffman & Associates..	134	Radio Wire Television, Inc.....	Diamond Seidman Company.....	104
DuMont, Allen B. Labs., Inc.....	Austin C. Lescarboursa & Staff..	20	Radolek Co.....	Turner Advertising Agency.....	151
Eastern Amplifier Corporation.....	Roberts and Reimers Inc.....	133	Raytheon Manufacturing Company.....	Burton Browne Advertising.....	73
Echophone Radio Co.....	Burton Browne Advertising.....	5	Rider, John F., Publisher, Inc.....	Lansford F. King.....	92
Electro-Voice Corporation.....	Shappe-Wilkes, Inc.....	113	Rowe Industries Co.....		138
Fada Radio & Electric Co., Inc.....	Sternfield-Godley, Inc.....	6, 114	Runzel Cord & Wire Co.....	Duane Wanamaker Adv.....	135
Federal Telephone & Radio Corp.....	Commerce Adv. Agency.....	150	Sauereisen Cements Company.....		144
Federal Telephone & Radio Corp.....	Marschalk & Pratt Co. 93, 3rd cover		Sheffield Radio Co.....	Sander Rodkin Adv. Agency.....	118
Freed Transformer.....	Franklin Advertising Service.....	108	Shure Brothers.....	Henry H. Teplitz.....	95
Gates Radio Company.....	Henry J. Kaufman Adv.....	119	Solar Capacitor Sales Corp.....	O. S. Tyson & Company, Inc....	13
Gateway Publishing Company.....	Louis B. Didier.....	142	Sound Equipment Corporation.....	Beaumont and Hohman Inc.....	137
General Cement Mfg. Co.....	Turner Advertising Agency.....	116	Sperry Gyroscope Company, Inc.....	Young & Rubicam, Inc.....	109
General Ceramics & Steatite Corp.....	O. S. Tyson & Company, Inc.....	77	Sperry Gyroscope Company, Inc.....	Equity Advertising Agency.....	148
General Test Equipment Co.....	Suzanne Hayman, Adv.....	151	Sprague Products Co.....	Harry P. Bridge Co., The.....	79
Gothard Manufacturing Company.....	Merchandising Advertisers.....	114	Sprayberry Academy of Radio.....	Harry P. Bridge Co., The.....	19
Greenlee Tool Co.....	Howard H. Monk and Associates	132	Standard Transformer Corporation..	Burnet-Kuhn Advertising Co....	76
Guardian Electric Mfg. Company.....	Kennedy & Company.....	127	Stanwyck Winding Company.....	Franklin Advertising Service.....	130
Hallicrafters Company, The.....	Burton Browne Adv.....	Back Cover	Stevens Walden, Inc.....	Howard-Wesson Co.....	14
Hammarlund Mfg. Co., Inc., The.....	Roeding & Arnold, Inc.....	24	Stromberg Carlson Company.....	McCann-Erickson, Inc.....	139
Harco Steel Construction Co.....	Lewis Advertising Agency.....	142	Superior Instruments Co.....	Loewy Advertising Agency.....	125
Harvey Radio Company.....	Shappe-Wilkes, Inc.....	70	Supreme Instruments Corp.....	O'Callaghan Adv. Agy.. Inc.....	18
Hazeltine Corporation.....	Equity Advertising Agency.....	149	Sylvania Electric Products Inc.....	Newell-Emmett Company.....	11
Hytron Corporation.....	Henry A. Loudon Advertising.....	85	Talk-a-Phone Mfg. Co.....	Dwight M. Blish.....	138
Illinois Condenser Company.....	Sander Rodkin Adv. Agency.....	136	Teleplex Co.....	Terrill Balknap Marsh Associates	140
International Detrola Corporation.....	Zimmer-Keller, Inc.....	67	Templetone Radio Mfg. Corp.....	Peck Advertising Agency, Inc.....	123
Islip Radio Manufacturing Corp.....	Kotula Company.....	134	Triplett Electrical Instrument Co...	Western Advertising Agency.....	107
Jensen Industries, Inc.....	Allen D. Parsons Agency.....	146	Turner Company, The.....	W. D. Lyon Co., The.....	115
Jensen Radio Manufacturing Co.....	Burton Browne Advertising.....	7	United Electronics Company.....	A. W. Lewin Co.....	117
Johnson, E. F., Company.....	David, Inc.....	16, 89, 124	United Transformer Co.....	Shappe-Wilkes, Inc.....	99
Kaar Engineering Co.....		22	Universal Microphone Company.....	Ralph L. Powers, Ph. D.....	23
Kato Engineering Co.....		136	Utah Radio Products Company.....	Abbott Kimball Co., Inc.....	75
Kelnor Manufacturing Company.....	Kelso Norman Advertising.....	128	Valparaiso Technical Institute.....	Smith, Benson & McClure, Inc.	151
Kurz-Kasch, Inc.....	Kircher, Lytle, Helton & Collett	97	Wallace, Wm. T., Mfg. Co.....	Michael F. Mayger, Adv.....	102
Lake Radio Sales Co.....	Sander Rodkin Adv. Agency.....	118	Ward Leonard Electric Company.....	E. M. Freystadt Associates, Inc.	10
Lectrohm, Incorporated.....	Merchandising Advertisers.....	140	Ward Products Corporation, The.....	Burton Browne Advertising.....	63
Lectrolab Products.....	Sander Rodkin Adv. Agency.....	108	Warner Electric Co.....	Mason Warner Co.....	122, 146
Lifetime Sound Equipment Co.....		126	Western Electric Co.....	Deutsch & Shea.....	148
Lincoln Engineering School.....	Buchanan Thomas Adv. Co.....	151	Westinghouse Electric & Mfg. Co...	Fuller & Smith & Ross, Inc....	131
Mallory, P. R. & Co., Inc.....	Aitkin-Kynett Co.....	9	Westinghouse Electric & Mfg. Co...		149
Meck, John Industries.....	Fensholt Company.....	2nd Cover	Wholesale Radio Laboratories.....	Allen & Reynolds.....	96
Meissner Manufacturing Company.....	Gardner Advertising Co.....	83	York Radio Distributing Company.....		151

MAXIMUM CAPACITANCE at minimum cost...

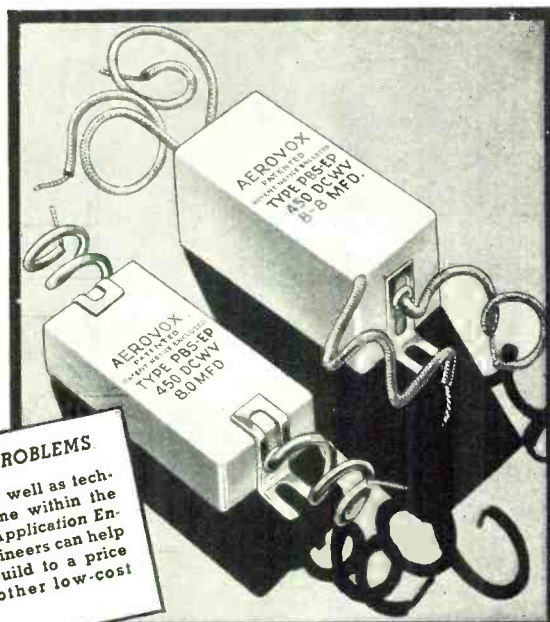

SUBMIT YOUR PROBLEMS
Your cost figures, as well as technical problems, come within the scope of Aerovox Application Engineering. Our engineers can help you design and build to a price with these and other low-cost types. Write us.

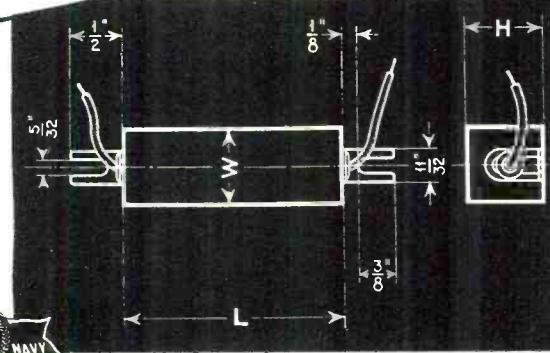
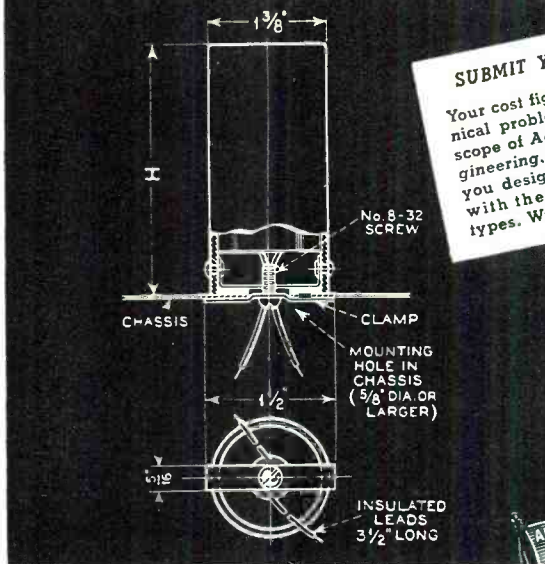

CLAMP-MOUNTING ELECTROLYTICS

● **PRICE** with inbuilt Aerovox Quality—that's the prime objective of the ingenious Type PRV one-hole-mounting paper-cased electrolytic. • Wax sealed. Impregnated cardboard-tube container. Suitable for commercial and other applications where extreme operating conditions are not encountered and metal-can types are not essential. • Note ingenious clamp and center-screw mounting means. This type can take the place of various other vertical-mounting electrolytics such as twist-prong, spade-lug, screw-base, etc. • Normally with etched foil. Also available in plain foil. High-purity aluminum elements throughout. Positive and negative lead for each section. 450 and 600 v. D.C.W. 4 to 40 mfd.; 8-8 to 20-20 mfd. 1-3/8" dia.; 3 to 4-3/4" high.

CARDBOARD-CASE ELECTROLYTICS

● **PRICE** with inbuilt Aerovox Quality—that's the prime objective of this popular Type PBS rectangular cardboard-case dry electrolytic. • Sections housed in sturdy cardboard containers. Patented Aerovox Adjustimount or swivel metal flange permits mounting flatwise or on narrow side according to space limitations. Also, PBS units may be stacked and held together by overlapping metal flange and soldering securely. • Normally with etched foil. Plain foil also available. High-purity aluminum elements throughout. Made in single and multiple sections. Separate sections with positive and negative leads for each section. • 450 and 600 v. D.C.W. 4 to 16 mfd.; 8-8, 8-16 and 8-8-8 mfd. Dimensions: L, 2-7/16 to 3-3/16"; W, 3/4 to 1-1/2"; H, 1/2 to 1-7/16". A good general-purpose electrolytic for normal service.



INDIVIDUALLY TESTED

AEROVOX CORPORATION, NEW BEDFORD, MASS., U. S. A. SALES OFFICES IN ALL PRINCIPAL CITIES
Export: 13 E. 40 ST., NEW YORK 16, N. Y. Cable: 'ARLAB' In Canada: AEROVOX CANADA LTD., HAMILTON, ONT.

Centralab

Lever Action SWITCHES

THESE low-capacity space-saving switches are used singly and in groups.

In shops and laboratories, by experimenters and by manufacturers these Centralab switches are becoming increasingly popular.

They are particularly adapted to broadcasting, receiving, public address, test instruments and individual uses.

These Centralab switches are available in ten different combinations including positive and spring return action types with either shorting or non-shorting contacts.

Be sure to specify "CENTRALAB" when ordering Lever Action Switches.



Centralab

Division of GLOBE-UNION INC., Milwaukee

PRODUCERS of Variable Resistors; Selector Switches; Ceramic Capacitors, Fixed and Variable; Steatite Insulators and Silver Mica Capacitors.

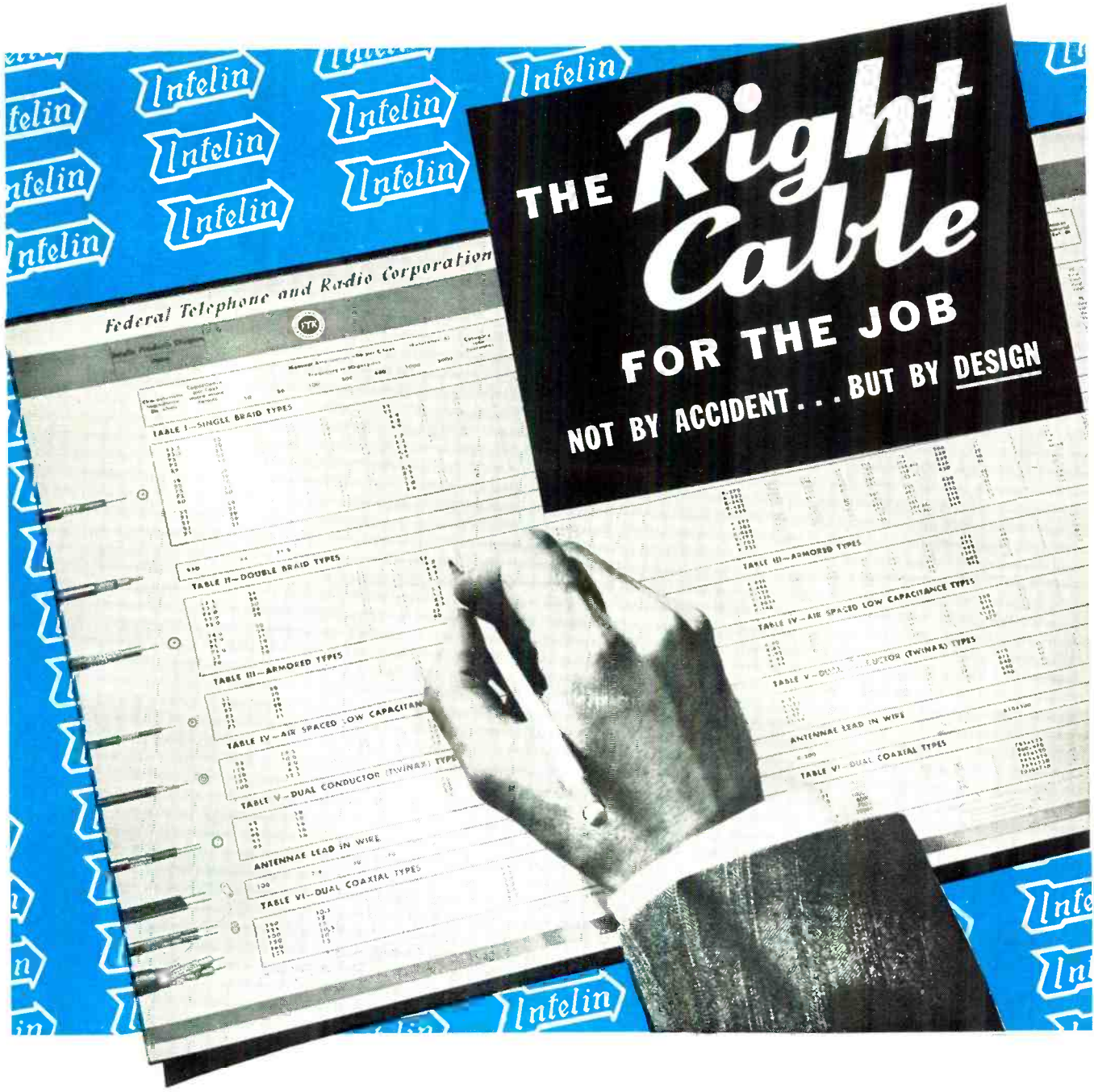

To assist the equipment designer Federal offers comprehensive data on high frequency cables.

This technical information sheet provides the design-engineer with pertinent electrical and physical characteristics...including impedance, capacitance, attenuation, diameter, materials, and weight... for Federal's wide variety of high-frequency cables.

Single and double braid, armored, dual con-

ductor and dual coaxial, air-spaced, low capacitance lines, and antenna lead-in wire... there's a right type for your job, backed by the built-in superiority that's a tradition with Federal.

Special developments in flexible low-loss cables by Federal have resulted in superior cables for all types of transmission. For a better job, see Federal first.

Write for your cable information sheet today.



Federal Telephone and Radio Corporation
 Newark 1, N. J.
 AN IT&T ASSOCIATE



MESSAGES GOT THROUGH

ON THE "BANANA NET"

THERE is many an exciting story about how amateur radio operators now in the services have helped extend the lines of victory around the world. There's the one about the "Banana Net"—the name the boys gave to the radio network down in the Panama jungle. As the G. I.'s have it, "it rains continually during the rainy season but only once a day in the dry season". The "Banana Net" is just one link in the vast network set up by the AACS—Army Airways Communications System. The AACS safeguards tens of thousands of lives by relaying weather reports, coordinating information on enemy movements and by bringing home or locating flying ships that are down or in trouble.

The ranks of the far flung AACS are filled with one-time amateur radio operators. Amateurs have always found in Hallicrafters equipment the perfection they themselves have been seeking. For these exacting technicians Hallicrafters made superior equipment long before the war. As a matter of fact thousands of pieces of privately owned Hallicrafters equipment were drafted into the services right along with the amateurs who once operated them. After the war Hallicrafters will have a new kind of radio ready. Discriminating listeners will want the radio man's radio—the radio that has an amazing range and performance on all bands, short wave and regular broadcast.



This is Hallicrafters new Model SX-28A, latest version of the famous Super Skyrider. It is a 15-tube communications receiver operating on a frequency range of 500 kc to 42 Mc, continuous in 6 bands including the regular broadcast band.



BUY A WAR BOND TODAY!

hallicrafters RADIO

THE HALLCRAFTERS CO. • MANUFACTURERS OF RADIO AND ELECTRONIC EQUIPMENT • CHICAGO 16, U. S. A.